

**REPORT NUMBER: 208-MGA-2023-004**

**VEHICLE SAFETY COMPLIANCE TESTING  
FOR  
FMVSS 208, OCCUPANT CRASH PROTECTION  
FMVSS 212, WINDSHIELD MOUNTING  
FMVSS 219, WINDSHIELD INTRUSION (PARTIAL)  
FMVSS 301, FUEL SYSTEM INTEGRITY**

**VOLVO CAR CORPORATION  
2023 VOLVO XC40  
NHTSA NO.: C20235900**

**PREPARED BY:  
MGA RESEARCH CORPORATION  
5000 WARREN ROAD  
BURLINGTON, WI 53105**



**TEST DATES: FEBRUARY 24, 2023 – SEPTEMBER 19, 2023**

**FINAL REPORT DATE: OCTOBER 27, 2023**

**FINAL REPORT**

**PREPARED FOR:  
U.S. DEPARTMENT OF TRANSPORTATION  
NATIONAL HIGHWAY TRAFFIC SAFETY ADMINISTRATION  
OFFICE OF ENFORCEMENT  
OFFICE OF VEHICLE SAFETY COMPLIANCE  
1200 NEW JERSEY AVENUE, S.E. NVS-220  
WASHINGTON, D.C. 20590**

This final test report was prepared for the U.S. Department of Transportation, National Highway Traffic Safety Administration, in response to Contract Number 693JJ919D000012.

This publication is distributed by the U.S. Department of Transportation, National Highway Traffic Safety Administration, in the interest of information exchange. The opinions, findings and conclusions expressed in this publication are those of the author(s) and not necessarily those of the Department of Transportation or the National Highway Traffic Safety Administration. The United States Government assumes no liability for its contents or use thereof. If trade or manufacturers' names or products are mentioned it is only because they are considered essential to the object of the publication and should not be construed as an endorsement. The United States Government does not endorse products or manufacturers.

Prepared by:  Date: October 27, 2023  
Jose Galvez, Project Engineer

Reviewed by:  Date: October 27, 2023  
David Winkelbauer, Facility Director

Accepted By:   
COR

Acceptance Date: October 27, 2023

**Technical Report Documentation Page**

1. Report No. 208-MGA-2023-004		2. Government Accession No.		3. Recipient's Catalog No.	
4. Title and Subtitle Final Report of FMVSS 208 Compliance Testing of a 2023 Volvo XC40 NHTSA No.: C20235900				5. Report Date October 27, 2023	
				6. Performing Organization Code MGA	
7. Author(s) Jose Galvez, Project Engineer				8. Performing Organization Report No. 208-MGA-2023-004	
9. Performing Organization Name and Address MGA Research Corporation 5000 Warren Road Burlington, WI 53105				10. Work Unit No.	
				11. Contract or Grant No. 693JJ919D000012	
12. Sponsoring Agency Name and Address U.S. Department of Transportation National Highway Traffic Safety Administration Enforcement Office of Vehicle Safety Compliance Mail Code: NEF-240 1200 New Jersey Avenue, S.E. Washington, D.C. 20590				13. Type of Report and Period Covered 2/24/23 – 9/19/23	
				14. Sponsoring Agency Code NEF-240	
15. Supplementary Notes					
16. Abstract Compliance tests were conducted on the subject 2023 Volvo XC40 in accordance with the specifications of the Office of Vehicle Safety Compliance Test Procedure No. TP208-14. Test failures identified were as follows:  TEST FAILURES: None					
17. Key Words  Frontal Impact 56 kmph Vehicle Safety Compliance Testing FMVSS 208, "Occupant Crash Protection" FMVSS 212, "Windshield Mounting" FMVSS 219, (partial), "Windshield Zone Intrusion" FMVSS 301, "Fuel System Integrity"				18. Distribution Statement Copies of this report are available from the following: U.S. Department of Transportation National Highway Traffic Safety Administration Technical Information Services (TIS) Mail Code: NIO-120 1200 New Jersey Avenue, S.E. Washington, DC 20590 Phone: 202-366-2588	
19. Security Classif. (of this report) Unclassified		20. Security Classif. (of this page) Unclassified		21. No. of Pages 364	22. Price

## TABLE OF CONTENTS

<u>Section</u>		<u>Page No</u>
1	Purpose of Compliance Tests	1
2	Tests Performed	2
3	Injury Result Summary for FMVSS 208 Tests	4
4	Discussion of Tests (if applicable)	8
5	Test Data Sheets	9
<u>Data Sheet</u>		
1	COTR Vehicle Work Order	10
2	Report of Vehicle Condition	15
3	Certification Label and Tire Placard Information	17
4	Rear Seating Position Seat Belts	18
5	Air Bag Labels	19
6	FMVSS 208 Readiness Indicator	26
7	Passenger Air Bag Manual Cut-Off Device	27
8	Lap Belt Lockability	30
9	FMVSS 208 Seat Belt Warning System Check	43
10	Belt Contact Force	44
11	Latch Plate Access	54
12	Seat Belt Retraction	59
13	Seat Belt Guides and Hardware	65
16	Air Bag Suppression Telltale	70
17	Suppression Test Using 12-Month CRABI Dummy	71
18	Suppression Test Using Newborn Infant Dummy	81
25	Summary of Low Risk Deployment Using an Unbelted 3YO Dummy Position 1	82
26	Summary of Low Risk Deployment Using an Unbelted 3YO Dummy Position 2	83
27	Summary of Low Risk Deployment Using an Unbelted 6YO Dummy Position 1	84
28	Summary of Low Risk Deployment Using an Unbelted 6YO Dummy Position 2	85
29	Summary of Low Risk Deployment Using an Unbelted 5th% Dummy Position 1	86
30	Summary of Low Risk Deployment Using an Unbelted 5th% Dummy Position 2	87
32	Vehicle Weight, Fuel Tank, and Attitude Data	88
33	Vehicle Accelerometer Locations and Measurements	92
34	Photographic Targets	95
35	Camera Locations	100
36	Dummy Positioning	102
37	Dummy Measurements	118
38	Crash Test	121

<u>Data Sheet</u>		<u>Page No</u>
40	Accident Investigation Measurements	123
41	Windshield Mounting (FMVSS 212)	125
42	Windshield Zone Intrusion (FMVSS 219)	127
43	Fuel System Integrity (FMVSS 301)	129
<u>Appendix</u>		
A	Crash Test Data	A-1
B	Low Risk Test Data	B-1
C	Crash Test Photographs	C-1
D	Low Risk Photographs	D-1
E	Suppression Photographs	E-1
F	Instrumentation Calibration	F-1
G	Notice of Test Failure (If Applicable)	G-1

**SECTION 1**  
**PURPOSE OF COMPLIANCE TESTS**

This Federal Motor Vehicle Safety Standard 208 compliance test is part of a program conducted for the National Highway Traffic Safety Administration (NHTSA) by MGA Research Corporation (MGA) under Contract No.: 693JJ919D000012. The purpose of this test was to determine whether the subject vehicle, a 2023 Volvo XC40, NHTSA No.: C20235900, meets certain performance requirements of FMVSS 208, "Occupant Crash Protection"; FMVSS 212, "Windshield Mounting"; FMVSS 219, "Windshield Zone Intrusion"; and FMVSS 301, "Fuel System Integrity". The compliance test was conducted in accordance with OVSC Laboratory Test Procedure No.: TP208-14 dated April 16, 2008.

**SECTION 2**  
**TESTS PERFORMED**

Test Vehicle: 2023 Volvo XC40  
Test Program: FMVSS 208 Compliance

NHTSA No.: C20235900  
Test Dates: 2/24/23 – 9/19/23

The following checked items indicate the tests that were performed:

- |                                     |     |  |
|-------------------------------------|-----|--|
| <input checked="" type="checkbox"/> | 1.  | Rear seating position seat belts   |
| <input checked="" type="checkbox"/> | 2.  | Air bag labels (S4.5.1)  |
| <input checked="" type="checkbox"/> | 3.  | Readiness indicator (S4.5.2)   |
| <input checked="" type="checkbox"/> | 4.  | Passenger air bag manual cut-off device (S4.5.4)   |
| <input checked="" type="checkbox"/> | 5.  | Lap belt lockability (S7.1.1.5)  |
| <input checked="" type="checkbox"/> | 6.  | Seat belt warning system (S7.3)  |
| <input checked="" type="checkbox"/> | 7.  | Seat belt contact force (S7.4.3)   |
| <input checked="" type="checkbox"/> | 8.  | Seat belt latch plate access (S7.4.4)  |
| <input checked="" type="checkbox"/> | 9.  | Seat belt retraction (S7.4.5)  |
| <input checked="" type="checkbox"/> | 10. | Seat belt guides and hardware (S7.4.6)   |
| <input checked="" type="checkbox"/> | 11. | Air bag suppression telltale (S19.2.2)   |
| <input checked="" type="checkbox"/> | 12. | Suppression tests with 12-month-old CRABI dummy (Part 572, Subpart R)  |
| <input checked="" type="checkbox"/> | 13. | Suppression tests with Newborn infant (Part 572, Subpart K)  |
| <input type="checkbox"/>            | 14. | Suppression tests with 3-year-old dummy (Part 572, Subpart P)  |
| <input type="checkbox"/>            | 15. | Suppression tests with 6-year-old dummy (Part 572, Subpart N)  |
| <input checked="" type="checkbox"/> | 16. | Test of Reactivation of the passenger air bag system with an unbelted representative 5 <sup>th</sup> percentile female         |
| <input type="checkbox"/>            | 17. | Low risk deployment test with 12-month-old dummy (Part 572, Subpart R)   |
| <input checked="" type="checkbox"/> | 18. | Low risk deployment test with 3-year-old dummy (Part 572, Subpart P)   |
| <input checked="" type="checkbox"/> | 19. | Low risk deployment test with 6-year-old dummy (Part 572, Subpart N)   |
| <input checked="" type="checkbox"/> | 20. | Low risk deployment test with 5 <sup>th</sup> female dummy (Part 572, Subpart O)   |
| <input checked="" type="checkbox"/> | 21. | Impact Tests   |
| <input type="checkbox"/>            |     | <input type="checkbox"/> Frontal Oblique   |
| <input type="checkbox"/>            |     | <input type="checkbox"/> Belted 50 <sup>th</sup> male dummy driver and passenger (0 to 48 kmph) (S5.1.1(a))                    |
| <input type="checkbox"/>            |     | <input type="checkbox"/> Unbelted 50 <sup>th</sup> male dummy driver and passenger (0 to 48 kmph) (S5.1.2(a)(1))               |
| <input type="checkbox"/>            |     | <input type="checkbox"/> Unbelted 50 <sup>th</sup> male dummy driver and passenger (32 to 56 kmph) (S5.1.2(a)(1) or S5.1.2(b)) |
| <input checked="" type="checkbox"/> |     | <input checked="" type="checkbox"/> Frontal 0°   |
| <input type="checkbox"/>            |     | <input type="checkbox"/> Belted 50 <sup>th</sup> male dummy driver (0 to 56 kmph) (S5.1.1(b)(2))                               |
| <input type="checkbox"/>            |     | <input type="checkbox"/> Belted 50 <sup>th</sup> male dummy passenger (0 to 56 kmph) (S5.1.1.(b)(2))                           |
| <input checked="" type="checkbox"/> |     | <input checked="" type="checkbox"/> Belted 5 <sup>th</sup> female dummy driver (0 to 56 kmph) (S16.1(a)(2))                    |
| <input checked="" type="checkbox"/> |     | <input checked="" type="checkbox"/> Belted 5 <sup>th</sup> female dummy passenger (0 to 56 kmph) (S16.1(a)(2))                 |
| <input type="checkbox"/>            |     | <input type="checkbox"/> Unbelted 50 <sup>th</sup> male dummy driver (32 to 40 kmph) (S5.1.2(b))                               |
| <input type="checkbox"/>            |     | <input type="checkbox"/> Unbelted 50 <sup>th</sup> male dummy passenger (32 to 40 kmph) (S5.1.2(b))                            |
| <input type="checkbox"/>            |     | <input type="checkbox"/> Unbelted 5 <sup>th</sup> female dummy driver (32 to 40 kmph) (S16.1(b))                               |
| <input type="checkbox"/>            |     | <input type="checkbox"/> Unbelted 5 <sup>th</sup> female dummy passenger (32 to 40 kmph) (S16.1(b))                            |
| <input type="checkbox"/>            |     | <input type="checkbox"/> 40% Offset 0° Belted 5 <sup>th</sup> female dummy driver and passenger (0 to 56 kmph) (S18.1)         |
| <input type="checkbox"/>            | 22. | FMVSS 204 Indicant Test  |
| <input checked="" type="checkbox"/> | 23. | FMVSS 212 Indicant Test  |
| <input checked="" type="checkbox"/> | 24. | FMVSS 219 Indicant Test  |
| <input checked="" type="checkbox"/> | 25. | FMVSS 301 Frontal Test   |
| <input type="checkbox"/>            | 26. | FMVSS 305 Frontal Indicant Test  |

For the crash tests, the vehicle was instrumented with 8 accelerometers. The data from the vehicle and dummies were sampled at 10,000 samples per second and processed as specified in SAE J211/1 MAR95 and FMVSS 208, S4.13.

The dynamic tests were recorded using high-speed digital video.

The vehicle appears to meet the performance requirements to which it was tested.

**SECTION 3**

**INJURY RESULT SUMMARY FOR FMVSS 208 TESTS**

Test Vehicle: 2023 Volvo XC40  
 Test Program: FMVSS 208 Compliance

NHTSA No.: C20235900  
 Test Dates: 6/8/23 - 6/9/23

**3 Year-Old Low Risk Deployments**

**3 Year-Old SN 031 Position 1 (Chest On Instrument Panel) 6/8/23**

Injury Criteria	Max. Allowable Injury Assessment Values	Measured Value
HIC15	570	44
Peak Nij (Nte)	1.0	0.1
Time (ms)	NA	100.0
Peak Nij (Ntf)	1.0	0.3
Time (ms)	NA	12.1
Peak Nij (Nce)	1.0	0.0
Time (ms)	NA	35.5
Peak Nij (Ncf)	1.0	0.2
Time (ms)	NA	14.2
Neck Tension	1130 N	284
Neck Compression	1380 N	41
Chest g	55 g	11
Chest Displacement	34 mm	5

Second stage fire time of 190 ms; Injuries calculated on 0 ms to 100 ms

**3 Year-Old SN 031 Position 2 (Head On Instrument Panel) 6/9/23**

Injury Criteria	Max. Allowable Injury Assessment Values	Measured Value
HIC15	570	5
Peak Nij (Nte)	1.0	0.0
Time (ms)	NA	11.9
Peak Nij (Ntf)	1.0	0.0
Time (ms)	NA	11.7
Peak Nij (Nce)	1.0	0.4
Time (ms)	NA	29.1
Peak Nij (Ncf)	1.0	0.3
Time (ms)	NA	40.2
Neck Tension	1130 N	45
Neck Compression	1380 N	687
Chest g	55 g	7
Chest Displacement	34 mm	0

Second stage fire time of 190 ms; Injuries calculated on 0 ms to 100 ms

**SECTION 3**

**INJURY RESULT SUMMARY FOR FMVSS 208 TESTS**

Test Vehicle: 2023 Volvo XC40  
 Test Program: FMVSS 208 Compliance

NHTSA No.: C20235900  
 Test Dates: 6/7/23 - 6/8/23

**6 Year-Old Low Risk Deployments**

**6 Year-Old SN 155 Position 1 (Chest On Instrument Panel) 6/8/23**

Injury Criteria	Max. Allowable Injury Assessment Values	Measured Value
HIC15	700	71
Peak Nij (Nte)	1.0	0.2
Time (ms)	NA	32.4
Peak Nij (Ntf)	1.0	0.2
Time (ms)	NA	12.6
Peak Nij (Nce)	1.0	0.0
Time (ms)	NA	0.0
Peak Nij (Ncf)	1.0	0.2
Time (ms)	NA	15.7
Neck Tension	1490 N	235
Neck Compression	1820 N	116
Chest g	60 g	6
Chest Displacement	40 mm	1

Second stage fire time of 190 ms; Injuries calculated on 0 ms to 100 ms

**6 Year-Old SN 155 Position 2 (Head On Instrument Panel) 6/7/23**

Injury Criteria	Max. Allowable Injury Assessment Values	Measured Value
HIC15	700	5
Peak Nij (Nte)	1.0	0.4
Time (ms)	NA	72.2
Peak Nij (Ntf)	1.0	0.0
Time (ms)	NA	14.2
Peak Nij (Nce)	1.0	0.5
Time (ms)	NA	53.7
Peak Nij (Ncf)	1.0	0.1
Time (ms)	NA	10.1
Neck Tension	1490 N	151
Neck Compression	1820 N	454
Chest g	60 g	6
Chest Displacement	40 mm	0

Second stage fire time of 190 ms; Injuries calculated on 0 ms to 100 ms

**SECTION 3**

**INJURY RESULT SUMMARY FOR FMVSS 208 TESTS**

Test Vehicle: 2023 Volvo XC40  
 Test Program: FMVSS 208 Compliance

NHTSA No.: C20235900  
 Test Date: 6/7/23

**5<sup>th</sup> Percentile Female Low Risk Deployments**

**5<sup>th</sup> Percentile Female SN 510 Position 1 (Chin On Module) 6/7/23**

Injury Criteria	Max. Allowable Injury Assessment Values	Measured Value
HIC15	700	23
Peak Nij (Nte)	1.0	0.4
Time (ms)	NA	29.9
Peak Nij (Ntf)	1.0	0.3
Time (ms)	NA	5.6
Peak Nij (Nce)	1.0	0.0
Time (ms)	NA	210.8
Peak Nij (Ncf)	1.0	0.0
Time (ms)	NA	299.9
Neck Tension	2070 N	1020
Neck Compression	2520 N	23
Chest g	60 g	9
Chest Displacement	52 mm	7
Left Femur	6805 N	48
Right Femur	6805 N	63

Second stage fire time of 175 ms; Injuries calculated on 0 ms to 300 ms

**5<sup>th</sup> Percentile Female SN 510 Position 2 (Chin On Rim) 6/7/23**

Injury Criteria	Max. Allowable Injury Assessment Values	Measured Value
HIC15	700	28
Peak Nij (Nte)	1.0	0.5
Time (ms)	NA	14.9
Peak Nij (Ntf)	1.0	0.2
Time (ms)	NA	85.9
Peak Nij (Nce)	1.0	0.4
Time (ms)	NA	16.6
Peak Nij (Ncf)	1.0	0.2
Time (ms)	NA	93.3
Neck Tension	2070 N	764
Neck Compression	2520 N	93
Chest g	60 g	26
Chest Displacement	52 mm	31
Left Femur	6805 N	21
Right Femur	6805 N	35

Second stage fire time of 175 ms; Injuries calculated on 0 ms to 300 ms

**SECTION 3**

**INJURY RESULT SUMMARY FOR FMVSS 208 TESTS**

Test Vehicle: 2023 Volvo XC40  
 Test Program: FMVSS 208 Compliance

NHTSA No.: C20235900  
 Test Date: 9/19/23

**56 kmph Frontal Crash**

Impact Angle:	0°		
Belted Dummies:	X	Yes	No

Speed Range:		0 to 40 kmph		32 to 40 kmph
		0 to 48 kmph	X	0 to 56 kmph

Test Speed (kmph):	55.3	Test Weight (kg):	1855.7
--------------------	------	-------------------	--------

Driver Dummy:	X	5 <sup>th</sup> female		50 <sup>th</sup> male
Passenger Dummy:	X	5 <sup>th</sup> female		50 <sup>th</sup> male

**5<sup>th</sup> Percentile Female Frontal Crash Test  
 Vehicles certified to S16.1 (a) (1), S16.1 (a) (2), S16.1 (b), or S18.1**

Injury Criteria	Max. Allowable Injury Assessment Values	Driver	Passenger
HIC15	700	110	437
N <sub>te</sub>	1.0	0.2	0.3
N <sub>tf</sub>	1.0	0.3	0.2
N <sub>ce</sub>	1.0	0.0	0.3
N <sub>cf</sub>	1.0	0.1	0.2
Neck Tension	2620 N	845	763
Neck Compression	2520 N	67	164
Chest g	60 g	42	46
Chest Displacement	52 mm	20	18
Left Femur	6805 N	2236	2669
Right Femur	6805 N	1611	2423

**SECTION 4**  
**DISCUSSION OF TESTS**

Test Vehicle: 2023 Volvo XC40  
Test Program: FMVSS 208 Compliance

NHTSA No.: C20235900  
Test Dates: 2/24/23 – 9/19/23

A blanket and visor were not used in the suppression testing because they did not affect the sensing system used on the vehicle.

The pre-test photo “Pre-Test Left Rear Three-Quarter View of Test Vehicle” was not available for the report.

**SECTION 5**  
**TEST DATA SHEETS**

Test Vehicle: 2023 Volvo XC40  
Test Program: FMVSS 208 Compliance

NHTSA No.: C20235900  
Test Dates: 2/24/23 – 9/19/23

**DATA SHEET 1**  
**COTR VEHICLE WORK ORDER**

Test Vehicle: 2023 Volvo XC40  
Test Program: FMVSS 208 Compliance

NHTSA No.: C20235900  
Test Dates: 2/24/23 – 9/19/23

COTR Signature: Syed Rahaman

Test to be performed for this vehicle are checked below:

<input checked="" type="checkbox"/>	1.	Rear Seating Position Seat Belts						
<input checked="" type="checkbox"/>	2.	Air Bag Labels (S4.5.1)						
<input checked="" type="checkbox"/>	3.	Readiness Indicator (S4.5.2)						
<input checked="" type="checkbox"/>	4.	Passenger Air Bag Manual Cut-off Device (S4.5.4)						
<input checked="" type="checkbox"/>	5.	Lap Belt Lockability (S7.1.1.5)						
<input checked="" type="checkbox"/>	6.	Seat Belt Warning System (S7.3)						
<input checked="" type="checkbox"/>	7.	Seat Belt Contact Force (S7.4.3)						
<input checked="" type="checkbox"/>	8.	Seat Belt Latch Plate Access (S7.4.4)						
<input checked="" type="checkbox"/>	9.	Seat Belt Retraction (S7.4.5)						
<input checked="" type="checkbox"/>	10.	Seat Belt Guides and Hardware (S7.4.6)						
<input checked="" type="checkbox"/>	11.	Air bag suppression telltale (S19.2.2)						
<input checked="" type="checkbox"/>	12.	Suppression tests with 12-month-old CRABI dummy (Part 572, Subpart R) using the following indicated child restraints (mid-height seat position):						
		Section B – Rear Facing (unbelted and belted rear facing, unbelted forward facing)						
		Century Smart Fit 4543	<input type="checkbox"/>	Full Rearward	<input type="checkbox"/>	Mid Position	<input type="checkbox"/>	Full Forward
	<input checked="" type="checkbox"/>	Cosco Arriva 22-013	<input checked="" type="checkbox"/>	Full Rearward	<input checked="" type="checkbox"/>	Mid Position	<input checked="" type="checkbox"/>	Full Forward
		Evenflo Discovery Adjust Right 212	<input type="checkbox"/>	Full Rearward	<input type="checkbox"/>	Mid Position	<input type="checkbox"/>	Full Forward
		Graco Infant 8457	<input type="checkbox"/>	Full Rearward	<input type="checkbox"/>	Mid Position	<input type="checkbox"/>	Full Forward
	<input checked="" type="checkbox"/>	Graco Snugride	<input checked="" type="checkbox"/>	Full Rearward	<input checked="" type="checkbox"/>	Mid Position	<input checked="" type="checkbox"/>	Full Forward
	<input checked="" type="checkbox"/>	Peg Perego Viaggio	<input checked="" type="checkbox"/>	Full Rearward	<input checked="" type="checkbox"/>	Mid Position	<input checked="" type="checkbox"/>	Full Forward
		Section C – Convertible (unbelted and belted rear facing, unbelted and belted forward facing)						
	<input checked="" type="checkbox"/>	Britax Roundabout E9L02	<input checked="" type="checkbox"/>	Full Rearward	<input checked="" type="checkbox"/>	Mid Position	<input checked="" type="checkbox"/>	Full Forward
		Cosco High Back Booster 22-209	<input type="checkbox"/>	Full Rearward	<input type="checkbox"/>	Mid Position	<input type="checkbox"/>	Full Forward
	<input checked="" type="checkbox"/>	Cosco Summit Deluxe 22-262	<input checked="" type="checkbox"/>	Full Rearward	<input checked="" type="checkbox"/>	Mid Position	<input checked="" type="checkbox"/>	Full Forward
		Cosco Touriva 02519	<input type="checkbox"/>	Full Rearward	<input type="checkbox"/>	Mid Position	<input type="checkbox"/>	Full Forward
		Evenflo Generations 352	<input type="checkbox"/>	Full Rearward	<input type="checkbox"/>	Mid Position	<input type="checkbox"/>	Full Forward
		Evenflo Medallion 254	<input type="checkbox"/>	Full Rearward	<input type="checkbox"/>	Mid Position	<input type="checkbox"/>	Full Forward
	<input checked="" type="checkbox"/>	Evenflo Tribute V 379	<input checked="" type="checkbox"/>	Full Rearward	<input checked="" type="checkbox"/>	Mid Position	<input checked="" type="checkbox"/>	Full Forward
		Graco ComfortSport	<input type="checkbox"/>	Full Rearward	<input type="checkbox"/>	Mid Position	<input type="checkbox"/>	Full Forward
		Graco Platinum Cargo	<input type="checkbox"/>	Full Rearward	<input type="checkbox"/>	Mid Position	<input type="checkbox"/>	Full Forward
	<input checked="" type="checkbox"/>	Graco Safeseat Step 2	<input checked="" type="checkbox"/>	Full Rearward	<input checked="" type="checkbox"/>	Mid Position	<input checked="" type="checkbox"/>	Full Forward
<input checked="" type="checkbox"/>	13.	Suppression tests with newborn infant (Part 572, Subpart K) using the following indicated child restraints (mid-height seat position):						
		Section A – Car Bed (Belted)						
	<input checked="" type="checkbox"/>	Angel Guard Angel Ride	<input checked="" type="checkbox"/>	Full Rearward	<input checked="" type="checkbox"/>	Mid Position	<input checked="" type="checkbox"/>	Full Forward

14.	Suppression tests with 3-year-old dummy (Part 572, Subpart P) using the following indicated child restraints where a child restraint is required (mid-height seat position):			
	Section C – Convertible (Belted forward-facing)			
	Britax Roundabout E9L02	Full Rearward	Mid Position	Full Forward
	Cosco High Back Booster 22-209	Full Rearward	Mid Position	Full Forward
	Cosco Summit Deluxe 22-262	Full Rearward	Mid Position	Full Forward
	Cosco Touriva 02519	Full Rearward	Mid Position	Full Forward
	Evenflo Generations 352	Full Rearward	Mid Position	Full Forward
	Evenflo Medallion 254	Full Rearward	Mid Position	Full Forward
	Evenflo Tribute V 379	Full Rearward	Mid Position	Full Forward
	Graco ComfortSport	Full Rearward	Mid Position	Full Forward
	Graco Platinum Cargo	Full Rearward	Mid Position	Full Forward
	Graco Safeseat Step 2	Full Rearward	Mid Position	Full Forward
	Section D – Toddler/Belt Positioning Booster (Belted)			
	Britax Roadster 9004	Full Rearward	Mid Position	Full Forward
	Cosco High Back Booster 22-209	Full Rearward	Mid Position	Full Forward
	Cosco Summit Deluxe 22-262	Full Rearward	Mid Position	Full Forward
	Evenflo Generations 352	Full Rearward	Mid Position	Full Forward
	Evenflo Right Fit 245	Full Rearward	Mid Position	Full Forward
	Graco Platinum Cargo	Full Rearward	Mid Position	Full Forward
15.	Suppression tests with representative 3-year-old child using the following indicated child restraints where a child restraint is required (mid-height position). (Appendix H, Data Sheet 19H and 20H)			
	Section C – Convertible (Belted forward-facing)			
	Britax Roundabout E9L02	Full Rearward	Mid Position	Full Forward
	Cosco High Back Booster 22-209	Full Rearward	Mid Position	Full Forward
	Cosco Summit Deluxe 22-262	Full Rearward	Mid Position	Full Forward
	Cosco Touriva 02519	Full Rearward	Mid Position	Full Forward
	Evenflo Generations 352	Full Rearward	Mid Position	Full Forward
	Evenflo Medallion 254	Full Rearward	Mid Position	Full Forward
	Evenflo Tribute V 379	Full Rearward	Mid Position	Full Forward
	Graco ComfortSport	Full Rearward	Mid Position	Full Forward
	Graco Platinum Cargo	Full Rearward	Mid Position	Full Forward
	Graco Safeseat Step 2	Full Rearward	Mid Position	Full Forward
	Section D – Toddler/Belt Positioning Booster (Belted)			
	Britax Roadster 9004	Full Rearward	Mid Position	Full Forward
	Cosco High Back Booster 22-209	Full Rearward	Mid Position	Full Forward
	Evenflo Right Fit 245	Full Rearward	Mid Position	Full Forward

16. Suppression tests with 3-year-old dummy (Part 572, Subpart P) in the following positions (mid-height seat position):
- Sitting on seat with back against seat back (S22.2.2.1)
    - Full Rearward       Mid Position       Full Forward
  - Sitting on seat with back against reclined seat back (S22.2.2.2)
    - Full Rearward       Mid Position       Full Forward
  - Sitting on seat with back not against seat back (S22.2.2.3)
    - Full Rearward       Mid Position       Full Forward
  - Sitting on seat edge, spine vertical, hands by the child's side (S22.2.2.4)
    - Full Rearward       Mid Position       Full Forward
  - Standing on seat, facing forward (S22.2.2.5)
    - Full Rearward       Mid Position       Full Forward
  - Kneeling on seat facing forward (S22.2.2.6)
    - Full Rearward       Mid Position       Full Forward
  - Kneeling on seat facing rearward (S22.2.2.7)
    - Full Rearward       Mid Position       Full Forward
  - Lying on seat (S22.2.2.8)
    - Full Rearward       Mid Position       Full Forward
17. Suppression tests with representative 3-year-old child in the following positions (mid-height seat position):
- Sitting on seat with back against seat back (S22.2.2.1)
    - Full Rearward       Mid Position       Full Forward
  - Sitting on seat with back against reclined seat back (S22.2.2.2)
    - Full Rearward       Mid Position       Full Forward
  - Sitting on seat with back not against seat back (S22.2.2.3)
    - Full Rearward       Mid Position       Full Forward
  - Sitting on seat edge, spine vertical, hands by the child's side (S22.2.2.4)
    - Full Rearward       Mid Position       Full Forward
  - Standing on seat, facing forward (S22.2.2.5)
    - Full Rearward       Mid Position       Full Forward
  - Kneeling on seat facing forward (S22.2.2.6)
    - Full Rearward       Mid Position       Full Forward
  - Kneeling on seat facing rearward (S22.2.2.7)
    - Full Rearward       Mid Position       Full Forward
  - Lying on seat (S22.2.2.8)
    - Full Rearward       Mid Position       Full Forward
18. Suppression tests with 6-year-old dummy (Part 572, Subpart N) using the following indicated child restraints where a child restraint is required (mid-height seat position):
- Section D
- |   |  |                                       |                                       |
|---|--|---------------------------------------|---------------------------------------|
| <input type="checkbox"/> Britax Roadster 9004           | <input type="checkbox"/> Full Rearward | <input type="checkbox"/> Mid Position | <input type="checkbox"/> Full Forward |
| <input type="checkbox"/> Cosco High Back Booster 22-209 | <input type="checkbox"/> Full Rearward | <input type="checkbox"/> Mid Position | <input type="checkbox"/> Full Forward |
| <input type="checkbox"/> Cosco Summit Deluxe 22-262     | <input type="checkbox"/> Full Rearward | <input type="checkbox"/> Mid Position | <input type="checkbox"/> Full Forward |
| <input type="checkbox"/> Evenflo Generations 352        | <input type="checkbox"/> Full Rearward | <input type="checkbox"/> Mid Position | <input type="checkbox"/> Full Forward |
| <input type="checkbox"/> Evenflo Right Fit 245          | <input type="checkbox"/> Full Rearward | <input type="checkbox"/> Mid Position | <input type="checkbox"/> Full Forward |
| <input type="checkbox"/> Graco Platinum Cargo           | <input type="checkbox"/> Full Rearward | <input type="checkbox"/> Mid Position | <input type="checkbox"/> Full Forward |

19. Suppression tests with representative 6-year-old child using the following indicated child restraints where a child restraint is required (mid-height seat position):
- Section D
- |                          |                                |                          |               |                          |              |                          |              |
|--------------------------|--------------------------------|--------------------------|---------------|--------------------------|--------------|--------------------------|--------------|
| <input type="checkbox"/> | Britax Roadster 9004           | <input type="checkbox"/> | Full Rearward | <input type="checkbox"/> | Mid Position | <input type="checkbox"/> | Full Forward |
| <input type="checkbox"/> | Cosco High Back Booster 22-209 | <input type="checkbox"/> | Full Rearward | <input type="checkbox"/> | Mid Position | <input type="checkbox"/> | Full Forward |
| <input type="checkbox"/> | Cosco Summit Deluxe 22-262     | <input type="checkbox"/> | Full Rearward | <input type="checkbox"/> | Mid Position | <input type="checkbox"/> | Full Forward |
| <input type="checkbox"/> | Evenflo Generations 352        | <input type="checkbox"/> | Full Rearward | <input type="checkbox"/> | Mid Position | <input type="checkbox"/> | Full Forward |
| <input type="checkbox"/> | Evenflo Right Fit 245          | <input type="checkbox"/> | Full Rearward | <input type="checkbox"/> | Mid Position | <input type="checkbox"/> | Full Forward |
| <input type="checkbox"/> | Graco Platinum Cargo           | <input type="checkbox"/> | Full Rearward | <input type="checkbox"/> | Mid Position | <input type="checkbox"/> | Full Forward |
20. Suppression tests with 6-year-old dummy (Part 572, Subpart N) in the following positions (mid-height seat position):
- |                          |  |                          |               |                          |              |                          |              |
|--------------------------|--|--------------------------|---------------|--------------------------|--------------|--------------------------|--------------|
| <input type="checkbox"/> | Sitting on seat with back against seat back (S22.2.2.1)                          | <input type="checkbox"/> | Full Rearward | <input type="checkbox"/> | Mid Position | <input type="checkbox"/> | Full Forward |
| <input type="checkbox"/> | Sitting on seat with back against reclined seat back (S22.2.2.2)                 | <input type="checkbox"/> | Full Rearward | <input type="checkbox"/> | Mid Position | <input type="checkbox"/> | Full Forward |
| <input type="checkbox"/> | Sitting on seat edge, spine vertical, hands by the child's side (S22.2.2.4)      | <input type="checkbox"/> | Full Rearward | <input type="checkbox"/> | Mid Position | <input type="checkbox"/> | Full Forward |
| <input type="checkbox"/> | Sitting back in the seat and leaning on the right front passenger door (S24.2.3) | <input type="checkbox"/> | Full Rearward | <input type="checkbox"/> | Mid Position | <input type="checkbox"/> | Full Forward |
21. Suppression tests with representative 6-year-old child in the following positions (mid-height seat position):
- |                          |  |                          |               |                          |              |                          |              |
|--------------------------|--|--------------------------|---------------|--------------------------|--------------|--------------------------|--------------|
| <input type="checkbox"/> | Sitting on seat with back against seat back (S22.2.2.1)                          | <input type="checkbox"/> | Full Rearward | <input type="checkbox"/> | Mid Position | <input type="checkbox"/> | Full Forward |
| <input type="checkbox"/> | Sitting on seat with back against reclined seat back (S22.2.2.2)                 | <input type="checkbox"/> | Full Rearward | <input type="checkbox"/> | Mid Position | <input type="checkbox"/> | Full Forward |
| <input type="checkbox"/> | Sitting on seat edge, spine vertical, hands by the child's side (S22.2.2.4)      | <input type="checkbox"/> | Full Rearward | <input type="checkbox"/> | Mid Position | <input type="checkbox"/> | Full Forward |
| <input type="checkbox"/> | Sitting back in the seat and leaning on the right front passenger door (S24.2.3) |                          |               |                          |              |                          |              |
22. Test of Reactivation of the Passenger Air Bag System with an Unbelted 5<sup>th</sup> percentile female dummy (S20.3, 22.3, S24.3) (mid-height seat position). Perform this test after the following suppression tests: After each restraint.
23. Test of Reactivation of the Passenger Air Bag System with a representative 5<sup>th</sup> percentile female (S20.3, 22.3, S24.3) (mid-height seat position). Perform this test after the following suppression tests: After each restraint.
24. Low risk deployment test with 12-month-old dummy (Part 572, Subpart R) using the following indicated child restraints (full forward, mid-height seat position)(S20.4):
- Section B
- |                          |                                    |
|--------------------------|------------------------------------|
| <input type="checkbox"/> | Century Smart Fit 4543             |
| <input type="checkbox"/> | Cosco Arriva 22-013                |
| <input type="checkbox"/> | Evenflo Discovery Adjust Right 212 |
| <input type="checkbox"/> | Graco Infant 8457                  |
| <input type="checkbox"/> | Graco Snugride                     |
| <input type="checkbox"/> | Peg Perego Viaggio                 |
- Section C
- |                          |                         |
|--------------------------|-------------------------|
| <input type="checkbox"/> | Britax Roundabout E9L02 |
| <input type="checkbox"/> | Cosco Touriva 02519     |
| <input type="checkbox"/> | Evenflo Medallion 254   |
| <input type="checkbox"/> | Evenflo Tribute V 379   |
| <input type="checkbox"/> | Graco ComfortSport      |

25. Low risk deployment test with 3-year-old dummy (Part 572, Subpart P) in the following positions:
- Position 1 (rearmost, lowest seat position)
  - Position 2 (mid-height seat position)
26. Low risk deployment test with 6-year-old dummy (Part 572, Subpart N) in the following positions:
- Position 1 (rearmost, lowest seat position)
  - Position 2 (mid-height seat position)
27. Low risk deployment test with 5<sup>th</sup> female dummy (Part 572, Subpart O) in the following positions:
- Position 1 (mid-height seat position)
  - Position 2 (mid-height seat position)
28. Impact Tests
- |                                     | Frontal Oblique                     | Impact Angle:   | Test Speed: |
|-------------------------------------|-------------------------------------|---|-------------|
| <input type="checkbox"/>            | <input type="checkbox"/>            | Belted 50 <sup>th</sup> male dummy driver and passenger (0 to 48 kmph) (S5.1.1(a))                    |             |
|                                     | <input type="checkbox"/>            | Unbelted 50 <sup>th</sup> male dummy driver and passenger (0 to 48 kmph) (S5.1.2(a)(1))               |             |
|                                     | <input type="checkbox"/>            | Unbelted 50 <sup>th</sup> male dummy driver and passenger (32 to 56 kmph) (S5.1.2(a)(2) or S5.1.2(b)) |             |
| <input checked="" type="checkbox"/> | <input checked="" type="checkbox"/> | Frontal 0° - Test Speed: 55.3 kmph  |             |
|                                     | <input type="checkbox"/>            | Belted 50 <sup>th</sup> male dummy driver (0 to 56 kmph) (S5.1.1(b)(2))                               |             |
|                                     | <input type="checkbox"/>            | Belted 50 <sup>th</sup> male dummy passenger (0 to 56 kmph) (S5.1.1.(b)(2))                           |             |
|                                     | <input checked="" type="checkbox"/> | Belted 5 <sup>th</sup> female dummy driver (0 to 56 kmph) (S16.1(a)(2))                               |             |
|                                     | <input checked="" type="checkbox"/> | Belted 5 <sup>th</sup> female dummy passenger (0 to 56 kmph) (S16.1(a)(2))                            |             |
|                                     | <input type="checkbox"/>            | Unbelted 50 <sup>th</sup> male dummy driver (32 to 40 kmph) (S5.1.2(b))                               |             |
|                                     | <input type="checkbox"/>            | Unbelted 50 <sup>th</sup> male dummy passenger (32 to 40 kmph) (S5.1.2(b))                            |             |
|                                     | <input type="checkbox"/>            | Unbelted 5 <sup>th</sup> female dummy driver (32 to 40 kmph) (S16.1(b))                               |             |
|                                     | <input type="checkbox"/>            | Unbelted 5 <sup>th</sup> female dummy passenger (32 to 40 kmph) (S16.1(b))                            |             |
| <input type="checkbox"/>            | <input type="checkbox"/>            | 40% Offset 0° Belted 5 <sup>th</sup> female dummy driver and passenger (0 to 56 kmph) (S18.1)         |             |
|                                     |                                     | Test Speed:   |             |
29. FMVSS 204 Indicant Test
30. FMVSS 212 Indicant Test
31. FMVSS 219 Indicant Test
32. FMVSS 301 Frontal Test
33. FMVSS 305 Frontal Indicant Test

**DATA SHEET 2**  
**REPORT OF VEHICLE CONDITION**

Test Vehicle: 2023 Volvo XC40 NHTSA No.: C20235900  
Test Program: FMVSS 208 Compliance Test Dates: 2/24/23-9/19/23

CONTRACT NO.: 693JJ919D000012 Date: 9/26/23

FROM (Lab and rep name): MGA Research Corporation

TO: NHTSA, OVSC, NVS-220

PURPOSE: ( ) Initial Receipt ( ) Received via Transfer (X) Present vehicle condition

MODEL YEAR/MAKE/MODEL/BODY STYLE: 2023 Volvo XC40 MPV

MANUFACTURE DATE: 06/22

NHTSA NO. C20235900 GVWR: 2229 kg (4915 lbs)

BODY COLOR: Silver Dawn Metallic GAWR (Fr): 1188 kg (2620 lbs)

VIN: YV4K92HK4P2917194 GAWR (Rr): 1088 kg (2400 lbs)

ODOMETER READINGS: ARRIVAL (miles): 537 DATE: 2/22/23

COMPLETION (miles): 545 DATE: 9/19/23

PURCHASE PRICE: (\$) 40,830

DEALER'S NAME: Volvo Cars Ontario  
1300 Auto Center Dr, Ontario, CA 91761

- A. All options listed on window sticker are present on the test vehicle:  
 Yes  No
- B. Tires and wheel rims are new and the same as listed:  Yes  No
- C. There are no dents or other interior or exterior flaws:  Yes  No
- D. The vehicle has been properly prepared and is in running condition:  
 Yes  No
- E. Keyless remote is available and working:  Yes  No
- F. The glove box contains an owner's manual, warranty document, consumer information, and extra set of keys:  Yes  No
- G. Proper fuel filler cap is supplied on the test vehicle:  Yes  No
- H. Using permanent marker, identify vehicle with NHTSA number and FMVSS test type(s) on roof line above driver door or for school buses, place a placard with NHTSA number inside the windshield and to the exterior front and rear side of bus:  
 Yes  No
- I. Place vehicle in storage area:  Yes  No
- J. Inspect the vehicle's interior and exterior, including all windows, seats, doors, etc. to confirm that each system is complete and functional per the manufacturer's specifications. Any damage, misadjustment, or other unusual condition that could influence the test program or test results shall be recorded. Report any abnormal condition to the NHTSA COTR before beginning any test:  
 Vehicle OK  Conditions reported below in comment section

Identify the letter above to which any of the following comments apply.

Comments: \_\_\_\_\_  
\_\_\_\_\_

**REPORT OF VEHICLE CONDITION AT THE COMPLETION OF TESTING**

LIST OF FMVSS TESTS PERFORMED BY THIS LAB: FMVSS 208, 212, 219, 301

VEHICLE: 2023 Volvo XC40

NHTSA NO.: C20235900

REMARKS:

Equipment that is no longer on the test vehicle as noted on previous page:

Spare Tire and Cover, Front Underbody Cover, Cargo Carpet

Explanation for equipment removal:

Components removed for instrumentation installation and to meet target weight.

Test Vehicle Condition:

35 mph frontal impact damage- front suspension & structure damaged, hood & front quarter panels damaged, radiator damaged, air bags & pretensioners deployed, Stoddard in fuel system

RECORDED BY: Jose Galvez

DATE: 9/26/23

APPROVED BY: David Winkelbauer

DATE: 9/26/23

#####

**RELEASE OF TEST VEHICLE**

The vehicle described above is released from MGA to be delivered to:

Date:

Time:

Odometer:

Lab Rep's Signature:

Title:

Carrier/Customer Rep:

Date:

**DATA SHEET 3**

**CERTIFICATION LABEL AND TIRE PLACARD INFORMATION**

Test Vehicle: 2023 Volvo XC40  
 Test Program: FMVSS 208 Compliance  
 Test Technician: Chad Williams

NHTSA No.: C20235900  
 Test Date: 9/19/23

<b>Certification Label (Part 567)</b>	
Manufacturer:	Volvo Car Corporation
Date of Manufacture:	06/22
VIN:	YV4K92HK4P2917194
Vehicle Certified As (Pass. Car/MPV/Truck/Bus):	MPV
Front Axle GVWR:	1188 kg (2620 lbs)
Rear Axle GVWR:	1088 kg (2400 lbs)
Total GVWR:	2229 kg (4915 lbs)

<b>Tire Placard for Motor Vehicles with GVWR of 10,000 lb or Less and Passenger Cars (571.110)</b>	
Vehicle Capacity Weight:	420 kg (925 lbs)
Designated Seating Capacity Front:	2
Designated Seating Capacity Rear:	3
Total Designated Seating Capacity:	5
Recommended Cold Tire Inflation Pressure Front:	230 kpa (33 psi)
Recommended Cold Tire Inflation Pressure Rear:	230 kpa (33 psi)
Recommended Tire Size:	235/55R18
Tire Size on Vehicle:	235/55R18

Signature: 

Date: 9/19/23

**DATA SHEET 4**  
**REAR SEATING POSITION SEAT BELTS**

Test Vehicle: 2023 Volvo XC40  
Test Program: FMVSS 208 Compliance  
Test Technician: Jose Galvez

NHTSA No.: C20235900  
Test Date: 2/24/23

	Yes	No
Do all rear seating positions have Type 2 seat belts?	X	

If NO, describe the seat belt installed, the seat location, and any other information about the seat that would explain why a Type 2 seat belt was not installed.

REMARKS:

Signature:  Date: 2/24/23

**DATA SHEET 5**  
**AIR BAG LABELS (S4.5.1)**

Test Vehicle: 2023 Volvo XC40  
Test Program: FMVSS 208 Compliance  
Test Technician: Jose Galvez

NHTSA No.: C20235900  
Test Date: 2/24/23

1. Air Bag Maintenance Label and Owner's Manual Instructions: (S4.5.1(a))
- 1.1 Does the manufacturer recommend periodic maintenance or replacement of the air bag?  
 Yes (Go to 1.2)  
 No (Go to 2)
- 1.2 Does the vehicle have a label specifying air bag maintenance or replacement?  
 Yes – Pass  
 No – Fail
- 1.3 Does the label contain one of the following?  
 Yes – Pass  
 No – Fail
- Check applicable schedule:  
\_\_\_ Schedule on label specifies month and year (Record date\_\_\_\_\_)  
\_\_\_ Schedule on label specifies vehicle mileage (Record mileage\_\_\_\_\_)  
\_\_\_ Schedule on label specifies interval measured from date on certification label  
(Record interval\_\_\_\_\_)
- 1.4 Is the label permanently affixed within the passenger compartment such that it cannot be removed without destroying or defacing the label or vehicle part? (3/19/01 legal interpretation to Todd Mitchell)  
 Yes – Pass  
 No – Fail
- 1.5 Is the label lettered in English?  
 Yes – Pass  
 No – Fail
- 1.6 Is the label in block capitals and numerals?  
 Yes – Pass  
 No – Fail
- 1.7 Are the letters and numerals at least 3/32 inches high?  
 Yes – Pass  
 No – Fail
- 1.8 Does the owner's manual set forth the recommended schedule for maintenance or replacement?
2. Does the owner's manual: (S4.5.1(f))
- 2.1 Include a description of the vehicle's air bag system in an easily understandable format?  
 Yes – Pass  
 No – Fail
- 2.2 Include a statement that the vehicle is equipped with an air bag and a lap/shoulder belt at the front outboard seating position?  
 Yes – Pass  
 No – Fail
- 2.3 Include a statement that the air bag is a supplemental restraint at the front outboard seating position?  
 Yes – Pass  
 No – Fail

- 2.4 Emphasize that all occupants, including the driver, should always wear their seat belts whether or not an air bag is also provided at their seating positions to minimize the risk of severe injury or death in the event of a crash?  
 Yes – Pass  
 No – Fail
- 2.5 Provide any necessary precautions regarding the proper positioning of occupants, including children, at seating positions equipped with air bags to ensure maximum safety protection for those occupants?  
 Yes – Pass  
 No – Fail
- 2.6 Explain that no objects should be placed over or near the air bag on the steering wheel or on the instrument panel, because any such objects could cause harm if the vehicle is in a crash severe enough to cause the air bag to inflate?  
 Yes – Pass  
 No – Fail
- 2.7 Is the vehicle certified to meet the requirements of S14.5, S15, S17, S19, S21, S23, and S25? (Obtain answer to this question from the COTR) (S4.5.1(f)(2))  
 Yes – (Go to 2.7.1)  
 No – (Go to 3.)
- 2.7.1 Explain the proper functioning of the advanced air bag system? (S4.5.1(f)(2))  
 Yes – Pass  
 No – Fail
- 2.7.2 Provide a summary of the actions that may affect the proper functioning of the system? (S4.5.1(f)(2))  
 Yes – Pass  
 No – Fail
- 2.7.3 Present and explain the main components of the advanced passenger air bag system? (S4.5.1(f)(2)(i))  
 Yes – Pass  
 No – Fail
- 2.7.4 Explain how the components function together as part of the advanced passenger air bag system? (S4.5.1(f)(2)(ii))  
 Yes – Pass  
 No – Fail
- 2.7.5 Contain the basic requirements for proper operation, including an explanation of the actions that may affect the proper functioning of the system? (S4.5.1(f)(2)(iii))  
 Yes – Pass  
 No – Fail
- 2.7.6 Is the vehicle certified to the requirements of S19.2, S21.2, or 23.2 (automatic suppression)?  
 Yes, continue with 2.7.6  
 No, go to 2.7.7
- 2.7.6.1 Contain a complete description of the passenger air bag suppression system installed in the vehicle, including a discussion of any suppression zone? (S4.5.1(f)(2)(iv))  
 Yes – Pass  
 No – Fail
- 2.7.6.2 Discuss the telltale light, specifying its location in the vehicle and explaining when the light is illuminated?  
 Yes – Pass  
 No – Fail
- 2.7.7 Explain the interaction of the advanced passenger air bag system with other vehicle components, such as seat belts, seats or other components? (S4.5.1(f)(2)(v))  
 Yes – Pass  
 No – Fail

- 2.7.8 Summarize the expected outcomes when child restraint systems, children and small teenagers or adults are both properly and improperly positioned in the passenger seat, including cautionary advice against improper placement of child restraint systems? (S4.5.1(f)(2)(vi))
- Yes – Pass  
 No – Fail
- 2.7.9 Provide information on how to contact the vehicle manufacturer concerning modifications for persons with disabilities that may affect the advanced air bag system? (S4.5.1(f)(2)(vii))
- Yes – Pass  
 No – Fail
3. Sun Visor Air Bag Warning Label (S4.5.1(b)): Vehicles certified to meet the requirements of S19, S21 and S23. (S4.5.1(b)(3))
- 3.1 Is the label permanently affixed (including permanent marking on the visor material or molding into the visor material) to either side of the sun visor at each front outboard seating position such that it cannot be removed without destroying or defacing the label or the sun visor? (S4.5.1(b)(3)) (3/19/01 legal interpretation to Todd Mitchell)
- Driver Side, Yes – Pass  
 Driver Side, No – Fail  
 Passenger Side, Yes – Pass  
 Passenger Side, No – Fail
- 3.2 Does the label conform in content to the label shown in Figure 11 at each front outboard seating position? (S4.5.1(b)(2)) **(Vehicles without back seats or the back seat is too small to accommodate a rear-facing child restraint may omit the statement: “Never put a rear-facing child seat in the front.” (S4.5.1(b)(3)(v)))**



Figure 11. Sun Visor Label Visible when Visor is in Down Position.



Figure 6b. Sun Visor Label Visible When Visor is in Down Position.

- Driver Side, Yes – Pass  
 Driver Side, No – Fail  
 Passenger Side, Yes – Pass  
 Passenger Side, No – Fail

- 3.3 Is the label heading area yellow with the word "WARNING" and the alert symbol in black? (S4.5.1(b)(3)(i))
- Driver Side, Yes – Pass  
 Driver Side, No – Fail  
 Passenger Side, Yes – Pass  
 Passenger Side, No – Fail
- 3.4 Is the message area white with black text? (S4.5.1(b)(3)(ii))
- Driver Side, Yes – Pass  
 Driver Side, No – Fail  
 Passenger Side, Yes – Pass  
 Passenger Side, No – Fail
- 3.5 Is the message area at least 30 cm<sup>2</sup>? (S4.5.1(b)(3)(ii))
- The message area consists of the total label area minus the yellow heading area and the pictogram. The pictogram is enclosed on the left side and bottom by the edge of the label. The top edge of the pictogram area is defined by a horizontal line midway between the uppermost edge of the pictogram and the lowermost edge of the text. The right side of the pictogram is defined by a vertical line midway between the rightmost edge of the pictogram and the left most edge of the text, including any bullets. (See 5/6/03 interpretation to Gerald Plante on behalf of Subaru)**
- Driver Side: Length 70 mm, Width 45 mm  
 Passenger Side: Length 70 mm, Width 45 mm  
 Driver actual message area 31.5 cm<sup>2</sup>  
 Passenger actual message area 31.5 cm<sup>2</sup>
- Driver Side, Yes – Pass  
 Driver Side, No – Fail  
 Passenger Side, Yes – Pass  
 Passenger Side, No – Fail
- 3.6 Is the pictogram black on a white background? (S4.5.1(b)(3)(iii))
- Driver Side, Yes – Pass  
 Driver Side, No – Fail  
 Passenger Side, Yes – Pass  
 Passenger Side, No – Fail
- 3.7 Is the pictogram at least 30 mm in length? (S4.5.1(b)(3)(iii))
- Driver side: Length: 42 mm  
 Passenger side: Length: 42 mm
- Driver Side, Yes – Pass  
 Driver Side, No – Fail  
 Passenger Side, Yes – Pass  
 Passenger Side, No – Fail
- 3.8 Is the same side of the sun visor that contains the air bag warning label free of other information with the exception of the air bag maintenance label and/or the rollover-warning label? (S4.5.1(b)(5)(i))
- Driver Side, Yes – Pass  
 Driver Side, No – Fail  
 Passenger Side, Yes – Pass  
 Passenger Side, No – Fail
- 3.9 Is the sun visor free of other information about air bags or the need to wear seat belts with the exception of the air bag alert label and/or the rollover-warning label? (S4.5.1(b)(5)(ii))
- Driver Side, Yes – Pass  
 Driver Side, No – Fail  
 Passenger Side, Yes – Pass  
 Passenger Side, No – Fail

- 3.10 Does the driver side visor contain a rollover-warning label on the same side of the visor as the air bag warning label?  
 \_\_\_ Yes (go to 3.10.1)  
 No (go to 4., skipping 3.10.1 through 3.10.3)
- 3.10.1 Are both the rollover-warning label and the air bag warning label surrounded by a continuous solid-lined border?  
 \_\_\_ Yes (go to 3.10.2 and skip 3.10.3)  
 \_\_\_ No (go to 3.10.3 and skip 3.10.2)
- 3.10.2 Is the shortest distance from the border of the rollover label to the border of the air bag warning label at least 1 cm? (575.105 (d)(1)(iv)(B))  
 \_\_\_\_\_ actual distance  
 \_\_\_ Yes -Pass \_\_\_ **No-FAIL**
- 3.10.3 Is the shortest distance from any of the lettering or graphics on the rollover-warning label to any of the lettering or graphics of the air bag warning label at least 3 cm? (575.105 (d)(1)(iv)(A))  
 \_\_\_\_\_ actual distance  
 \_\_\_ Yes-Pass \_\_\_ **No-FAIL**
4. Air Bag Alert Label (S4.5.1(c) (A “Rollover Warning Label” or “Rollover Alert Label” may be on the same side of the driver’s sun visor as the “Air Bag Alert Label.” 575.105(d))
- 4.1 Is the Sun Visor Warning Label visible when the sun visor is in the stowed position?  
 **If yes for driver and passenger, go to 5.**  
 Driver Side, Yes  
 Driver Side, No  
 Passenger Side, Yes  
 Passenger Side, No
- 4.2 Is the air bag alert label permanently affixed (including permanent marking on the visor material or molding into the visor material) to the sun visor at each front outboard seating position such that it cannot be removed without destroying or defacing the label or the sun visor? (S4.5.1(c)) (3/19/01 legal interpretation to Todd Mitchell)  
 Driver Side, Yes – Pass  
 Driver Side, No – Fail  
 Passenger Side, Yes – Pass  
 Passenger Side, No – Fail
- 4.3 Is the air bag alert label visible when the visor is in the stowed position? (S4.5.1(c))  
 Driver Side, Yes – Pass  
 Driver Side, No – Fail  
 Passenger Side, Yes – Pass  
 Passenger Side, No – Fail

4.4 Does the label conform in content to the label shown in Figure 6C? (S4.5.1(c))

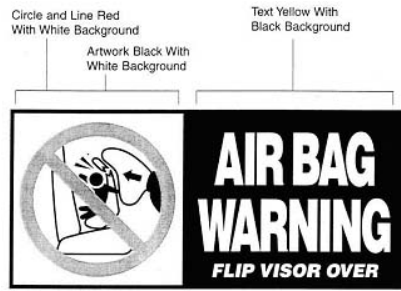

Figure 6c. Sun Visor Label Visible When Visor is in Up Position.

- Driver Side, Yes – Pass
- Driver Side, No – Fail
- Passenger Side, Yes – Pass
- Passenger Side, No – Fail

4.5 Is the message area black with yellow text? (S4.5.1(c)(1))

- Driver Side, Yes – Pass
- Driver Side, No – Fail
- Passenger Side, Yes – Pass
- Passenger Side, No – Fail

4.6 Is the message area at least 20 cm<sup>2</sup>? (S4.5.1(c)(1)) **The message area consists of the black part of the label.**

Driver Side: Length \_\_\_\_\_, Width \_\_\_\_\_  
 Passenger Side: Length \_\_\_\_\_, Width \_\_\_\_\_  
 Actual message area \_\_\_\_\_ cm<sup>2</sup>

- Driver Side, Yes – Pass
- Driver Side, No – Fail
- Passenger Side, Yes – Pass
- Passenger Side, No – Fail

4.7 Is the pictogram black with a red circle and slash on a white background? (S4.5.1(c)(2))

- Driver Side, Yes – Pass
- Driver Side, No – Fail
- Passenger Side, Yes – Pass
- Passenger Side, No – Fail

4.8 Is the pictogram at least 20 mm in diameter? (S4.5.1(c)(2))

Driver Side: Diameter \_\_\_\_\_ mm  
 Passenger Side: Diameter \_\_\_\_\_ mm

- Driver Side, Yes – Pass
- Driver Side, No – Fail
- Passenger Side, Yes – Pass
- Passenger Side, No – Fail

5. Label on the Dashboard: Vehicles certified to meet the requirements of S19, S21 and S23?

5.1 Does the vehicle have a label on the dash or steering wheel hub? (S4.5.1(e)(3))

Yes – Pass **The label was missing and it could not be determined when it was removed. Therefore it was not evaluated.**

No – Fail

5.2 Is the label clearly visible from all front seating positions? (S4.5.1(e)(3))

- Yes – Pass
- No – Fail

- 5.3 Does the label conform in content to the label shown in Figure 12? (S4.5.1(e)(3)) **Vehicles without back seats may omit the statement: “The back seat is the safest place for children.” Vehicles without back seats or too small to accommodate a rear-facing child restraint consistent with S4.5.4.1 as determined in DATA SHEET 7 may omit the statement “Never put a rear-facing child seat in the front.” (S4.5.1(e)(3)(iii))**
- Yes – Pass  
 No - Fail

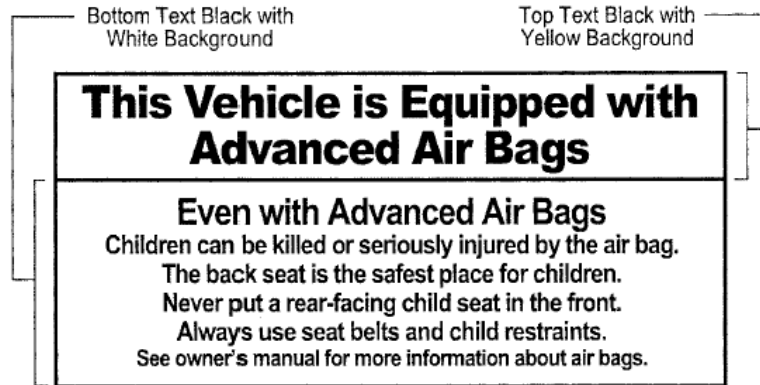

Figure 12. Removable Label on Dash.

- 5.4 Is the heading area yellow with black text? (S4.5.1(e)(3)(i))
- Yes – Pass  
 No - Fail
- 5.5 Is the message white with black text? (S4.5.1(e)(3)(ii))
- Yes – Pass  
 No - Fail
- 5.6 Is the message area at least 30 cm<sup>2</sup>? (S4.5.1(e)(3)(ii)) **The message area consists of the total label area minus the yellow heading area. (See 5/6/03 interpretation to Gerald Plante on behalf of Subaru)**
- Length \_\_\_ mm, Width \_\_\_ mm  
 Actual message area \_\_\_ cm<sup>2</sup>
- Yes – Pass  
 No - Fail

I certify that I have read and performed each instruction.

Signature: *Jose Galvez*

Date: 2/24/23

**DATA SHEET 6**  
**FMVSS 208 READINESS INDICATOR (S4.5.2)**

Test Vehicle: 2023 Volvo XC40  
Test Program: FMVSS 208 Compliance  
Test Technician: Jose Galvez

NHTSA No.: C20235900  
Test Date: 2/24/23

An occupant restraint system that deploys in the event of a crash shall have a monitoring system with a readiness indicator. A totally mechanical system is exempt from this requirement. (11/8/94 legal interpretation to Lawrence F. Hennegerger on behalf of Breed)

1. Is the system totally mechanical? **(If Yes, this Data Sheet is complete).**  
 Yes  
 No
2. Describe the location of the readiness indicator: *Instrument Cluster, Top Right Side*
3. Is the readiness indicator clearly visible to the driver?  
 Yes – Pass  
 No - Fail
4. Is a list of the elements in the occupant restraint system, being monitored by the readiness indicator, provided on a label or in the owner's manual?  
 Yes – Pass  
 No - Fail
5. Does the vehicle have an on-off switch for the passenger air bag?  
 If Yes (go to 6)  
 If No (this form is complete)
6. Is the air bag readiness indicator off when the passenger air bag switch is in the off position?  
 Yes – Pass  
 No - Fail

REMARKS:

I certify that I have read and performed each instruction.

Signature: 

Date: 2/24/23

DATA SHEET 7

PASSENGER AIR BAG MANUAL CUT-OFF DEVICE (S4.5.4)

Test Vehicle: 2023 Volvo XC40
Test Program: FMVSS 208 Compliance
Test Technician: Jose Galvez

NHTSA No.: C20235900
Test Date: 2/24/23

- 1. Is the vehicle equipped with an on-off switch that deactivates the air bag installed at the right front outboard seating position?
2. Does the vehicle have any forward-facing rear designated seating positions? (S4.5.4.1(a))
3. Verification there is room for a child restraint in the rear seat behind the driver's seat. (S4.5.4.1(b))
3.1 Using all the controls that affect the fore-aft movement of the seat, move the seat to the rearmost position. Mark this position.
3.2 Using all the controls that affect the fore-aft movement of the seat, move the seat to the foremost position. Mark this position.
3.3 Move the seat to the middle of the foremost and rearmost positions. (S8.1.2)
3.4 If the driver's seat height is adjustable, use all the controls that affect height to put it in the lowest position while maintaining the middle fore-aft position. (S8.1.2)
3.5 Position the driver's seat adjustable lumbar supports so that the lumbar support is in its lowest, retracted or deflated adjustment position. (S8.1.3)
3.6 The driver's seat back angle, if adjustable, is set at the manufacturer's nominal design riding position for a 50th percentile adult male in the manner specified by the manufacturer. (S4.5.4.1(b) and S8.1.3)
3.7 Is the driver seat a bucket seat?
3.7.1 Bucket seats:
3.7.1.1 Locate and mark a vertical Plane B through the longitudinal centerline of the driver's seat cushion. The longitudinal centerline of a bucket seat cushion is determined at SgRP. (S16.3.1.10) (S4.5.4.1(b)(1))
3.7.1.2 Locate the longitudinal horizontal line in plane B that is tangent to the highest point of the rear seat cushion behind the driver's seat. Measure along this line from the front of the seat back of the rear seat to the rear of the seat back of the driver's seat.
3.7.2 Bench seats (including split bench seats):
3.7.2.1 Locate and mark a vertical Plane B through the center of the steering wheel parallel to the vehicle longitudinal centerline. (S4.5.4.1(b)(2))

- 3.7.2.2 Locate the longitudinal horizontal line in plane B that is tangent to the highest point of the rear seat cushion. Measure along this line from the front of the seat back of the rear seat to the rear of the seat back of the front seat.  
 \_\_\_\_ mm distance  
 \_\_\_\_ less than 720 mm – Pass  
 \_\_\_\_ more than 720 mm - **FAIL**  
 Go to 4
4. Does the device turn the air bag on and off using the vehicle's ignition key? (S4.5.4.2)  
 Yes – Pass  
 No – Fail
5. Is the on-off device separate from the ignition switch? (S4.5.4.2)  
 Yes – Pass  
 No – Fail
6. Is there a telltale light that comes on when the passenger air bag is turned off? (S4.5.4.2)  
 Yes – Pass  
 No – Fail
7. Telltale light (S4.5.4.3)
- 7.1 Is the light yellow? (S4.5.4.3(a))  
 Yes – Pass  
 No – Fail
- 7.2 Are the words "PASSENGER AIR BAG OFF" or "PASS AIR BAG OFF" (S4.5.4.3(b))  
 7.2.1 on the telltale?  
 Yes – Pass, go to 7.3  
 No – go to 7.2.2
- 7.2.2 within 25 mm of the telltale?  
 Measurement from the edge of the telltale (mm):  
 Yes – Pass  
 No – Fail
- 7.3 Does the telltale remain illuminated while the air bag is turned off? (S4.5.4.3c)  
 (Leave the air bag off for 5 minutes.)  
 Yes – Pass  
 No – Fail
- 7.4 Is the telltale illuminated while the air bag is turned on? (S4.5.4.3(d))  
 Yes – Fail  
 No – Pass
- 7.5 Is the telltale combined with the air bag readiness indicator? (S4.5.4.3(e))  
 Yes – Fail  
 No – Pass
8. Owner's Manual
- 8.1 Does the owner's manual contain complete instructions on the operation of the on-off switch? (S4.5.4.4(a))  
 Yes – Pass  
 No – Fail

- 8.2 Does the owner's manual contain a statement that the on-off switch should only be used when a member of one of the following risk groups is occupying the right front passenger seating position? (S4.5.4.4(b))
- Infants:                   there is no back seat  
                                  the rear seat is too small to accommodate a child restraint  
                                  there is a medical condition that must be monitored constantly
- Children aged 1 to 12:   there is no back seat  
                                  space is not always available in the rear seat  
                                  there is a medical condition that must be monitored constantly
- Medical condition:       medical risk causes special risk for passenger  
                                  greater risk for harm than with the air bag on

- Yes – Pass  
 No – Fail

- 8.3 Does the owner's manual contain a warning about the safety consequences of using the on-off switch at other times?
- Yes – Pass  
 No – Fail

REMARKS:

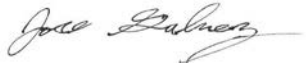
Signature: 

Date: 2/24/23

I certify that I have read and performed each instruction.

DATA SHEET 8

LAP BELT LOCKABILITY

Passenger cars, trucks, buses, and multipurpose passenger  
Vehicles with a GVWR of 10,000 pounds or less. (S7.1.1.5)

Test Vehicle: 2023 Volvo XC40  
Test Program: FMVSS 208 Compliance  
Test Technician: Jose Galvez

NHTSA No.: C20235900  
Test Date: 2/24/23

Complete one of these forms for **each** designated seating position that can be adjusted to forward-facing or that is a forward-facing seat, other than the driver's seat (S7.1.1.5(a), **and** that has seat belt retractors that are not solely automatic locking retractors. (S7.1.1.5(c))

DESIGNATED SEATING POSITION: **Front Passenger**

- N/A – No retractor is at this position
- N/A – The retractor is an automatic locking retractor ONLY
- 1. Record test fore-aft seat position: **REAR**  
(S7.1.1.5(c)(1)) (Any position is acceptable)
- 2. Does the lap belt portion of the seat belt in the forward-facing seat or seat that can be adjusted to forward-facing consist of a locking device that does **NOT** have to be attached by the vehicle user to the seat belt webbing, retractor, or any other part of the vehicle. (S7.1.1.5(a))
  - Yes – Pass
  - No – Fail
- 3. Does the lap belt portion of the seat belt in the forward-facing seat or seat that can be adjusted to forward-facing consist of a locking device that does **NOT** require inverting, twisting or deforming of the belt webbing. (S7.1.1.5(a))
  - Yes – Pass
  - No – Fail
- 4. Place any adjustable seat belt anchorage in the lowest adjustment position.
  - N/A The anchorage is not adjustable.
- 5. Buckle the seat belt. (S7.1.1.5(c)(1))
- 6. Locate a reference point A on the seat belt buckle. (S7.1.1.5(c)(2))
- 7. Locate a reference point B on the attachment hardware or retractor assembly at the other end of the lap belt or lap belt portion of the seat belt assembly. (S7.1.1.5(c)(2))
- 8. Does the vehicle user need to take some action to activate the locking feature on the lap belt portion of the seat belt in any forward-facing seat or seat that can be adjusted to forward-facing?
  - Yes (go to 8.1)
  - No (go to 9)
- 8.1 Does the vehicle owner's manual include a description in words and/or diagrams describing how to activate the locking feature so that the seat belt assembly can tightly secure a child restraint system and how to deactivate the locking feature to remove the child restraint system. (S7.1.1.5(b))
  - Yes – Pass
  - No – Fail
- 9. Adjust the lap belt or lap belt portion of the seat belt assembly according to any procedures recommended in the vehicle owner's manual to activate any locking feature so that the webbing between points A and B is at the maximum length allowed by the belt system. (S7.1.1.5(c)(2) & S7.1.1.5(c)(1))

10. Measure and record the distance between points A and B along the longitudinal centerline of the webbing for the lap belt or lap belt portion of the seat belt assembly. (S7.1.1.5(c)(2))  
Measured distance between A and B (inches): 61 ½
11. Readjust the belt system so that the webbing between points A and B is at ½ the maximum length of the webbing. (S7.1.1.5(c)(3))
12. To the lap belt or lap belt portion of the seat belt assembly, apply a preload of 10 pounds using the webbing tension pull device in Figure 5. Apply the load in a vertical plane parallel to the longitudinal axis of the vehicle and passing through the seating reference point of the designated seating position. Apply the preload in a horizontal direction toward the front of the vehicle with a force application angle of not less than 5 degrees nor more than 15 degrees above the horizontal. (S7.1.1.5(c)(4))  
Measured force application angle: 10° (spec. 5 - 15 degrees)
13. Measure the length between points A and B along the longitudinal centerline of the webbing while the preload is being applied. (S7.1.1.5(c)(4))  
Measured distance between A and B: 25 ½ inches
14. Increase the load to 50 pounds at a rate of no more than 50 pounds per second. Attain the load in not more than 5 seconds. (If webbing sensitive emergency locking retractors are installed as part of the lap belt or lap belt portion of the seat belt assembly, apply the load at a rate less than the threshold value for lock-up specified by the manufacturer.) Maintain the load for at least 5 seconds. Measure and record the distance between points A and B along the longitudinal centerline of the webbing. (S7.1.1.5(c)(5))  
Record onset rate: 15 lb/sec (spec. 10 to 50 lb/sec) (S7.1.1.5(c)(5))  
Measured distance between A and B: 27 inches (S7.1.1.5(c)(6))
15. Let the seat belt webbing retract to its minimum length with the seat belt still buckled.
16. To the lap belt or lap belt portion of the seat belt assembly, apply a preload of 10 pounds using the webbing tension pull device in Figure 5. Apply the load in a vertical plane parallel to the longitudinal axis of the vehicle and passing through the seating reference point of the designated seating position. Apply the preload in a horizontal direction toward the front of the vehicle with a force application angle of not less than 5 degrees nor more than 15 degrees above the horizontal. (S7.1.1.5(c)(4))  
Measured force application angle: 10° (spec. 5 - 15 degrees)
17. Measure the length between points A and B along the longitudinal centerline of the webbing while the preload is being applied. (S7.1.1.5(c)(4))  
Measured distance between A and B: 7 inches
18. Increase the load to 50 pounds at a rate of no more than 50 pounds per second. Attain the load in not more than 5 seconds. (If webbing sensitive emergency locking retractors are installed as part of the lap belt or lap belt portion of the seat belt assembly, apply the load at a rate less than the threshold value for lock-up specified by the manufacturer.) Maintain the load for at least 5 seconds. Measure and record the distance between points A and B along the longitudinal centerline of the webbing. (S7.1.1.5(c)(5))  
Record onset rate: 15 lb/sec (spec. 10 to 50 lb/sec) (S7.1.1.5(c)(5))  
Measured distance between A and B: 8 inches (S7.1.1.5(c)(6))
19. Subtract the measurement in 13 from the measurement in 14 and the measurement in 17 from the measurement in 18. Is the difference 2 inches or less for both? (S7.1.1.5(c)(7))  
14 – 13 = 27 – 25 ½ = 1 ½ inches;  
18 – 17 = 8 – 7 = 1 inch
- Yes – Pass  
 No – Fail

20. Subtract the measurement in 14 from the measurement in 10 and the measurement in 18 from the measurement in 10. Is the difference 3 inches or more for both?

(S7.1.1.5(c)(8))

10-14 =  $61 \frac{1}{2} - 27 = 34 \frac{1}{2}$  inches;

10-18 =  $61 \frac{1}{2} - 8 = 53 \frac{1}{2}$  inches

Yes – Pass

No – Fail

REMARKS:

Signature: 

Date: 2/24/23

I certify that I have read and performed each instruction.

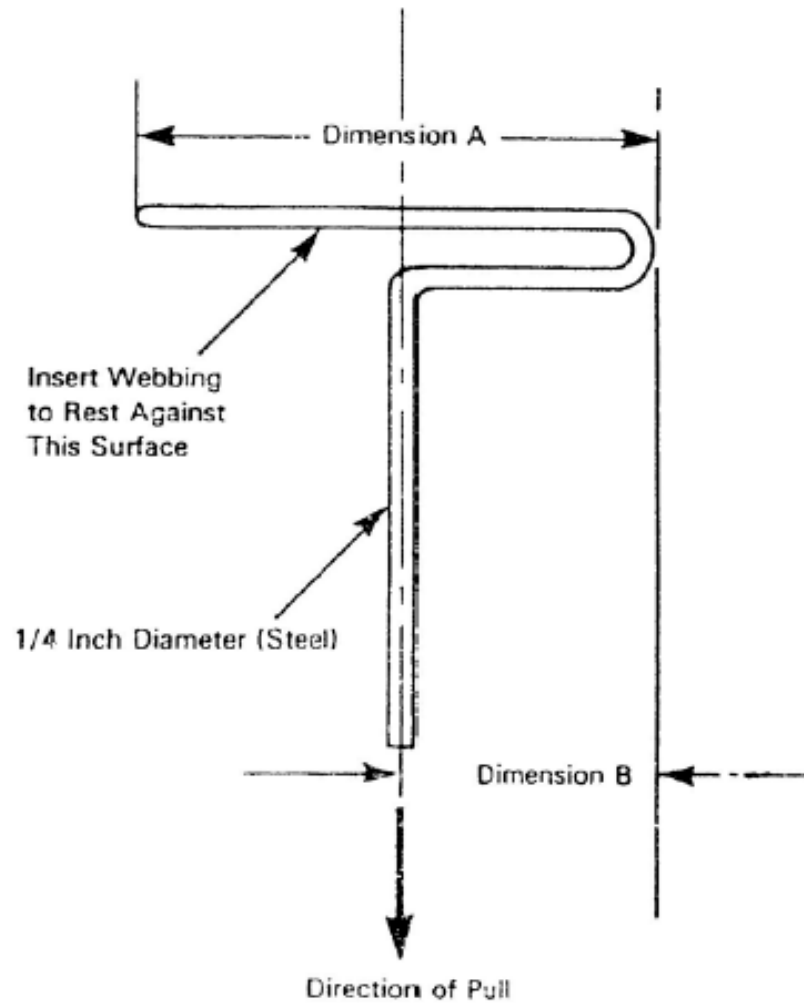

Dimension A - Width of Webbing Plus 1/2 Inch

Dimension B - 1/2 of Dimension A

**Figure 5. - Webbing Tension Pull Device**

**DATA SHEET 8**  
**LAP BELT LOCKABILITY**

**Passenger cars, trucks, buses, and multipurpose passenger  
Vehicles with a GVWR of 10,000 pounds or less. (S7.1.1.5)**

Test Vehicle: 2023 Volvo XC40  
Test Program: FMVSS 208 Compliance  
Test Technician: Jose Galvez

NHTSA No.: C20235900  
Test Date: 2/24/23

Complete one of these forms for **each** designated seating position that can be adjusted to forward-facing or that is a forward-facing seat, other than the driver's seat (S7.1.1.5(a), **and** that has seat belt retractors that are not solely automatic locking retractors. (S7.1.1.5(c))

DESIGNATED SEATING POSITION:	Left Rear Passenger
------------------------------	---------------------

- |                                     |     |   |
|-------------------------------------|-----|---|
| <input type="checkbox"/>            |     | N/A – No retractor is at this position  |
| <input type="checkbox"/>            |     | N/A – The retractor is an automatic locking retractor ONLY  |
| <input checked="" type="checkbox"/> | 1.  | Record test fore-aft seat position: <b>FIXED</b><br>(S7.1.1.5(c)(1)) (Any position is acceptable)   |
| <input checked="" type="checkbox"/> | 2.  | Does the lap belt portion of the seat belt in the forward-facing seat or seat that can be adjusted to forward-facing consist of a locking device that does <b>NOT</b> have to be attached by the vehicle user to the seat belt webbing, retractor, or any other part of the vehicle. (S7.1.1.5(a))        |
|                                     |     | <input checked="" type="checkbox"/> Yes – Pass  |
|                                     |     | <input type="checkbox"/> No – Fail  |
| <input checked="" type="checkbox"/> | 3.  | Does the lap belt portion of the seat belt in the forward-facing seat or seat that can be adjusted to forward-facing consist of a locking device that does <b>NOT</b> require inverting, twisting or deforming of the belt webbing. (S7.1.1.5(a))   |
|                                     |     | <input checked="" type="checkbox"/> Yes – Pass  |
|                                     |     | <input type="checkbox"/> No – Fail  |
| <input checked="" type="checkbox"/> | 4.  | Place any adjustable seat belt anchorage in the lowest adjustment position.   |
|                                     |     | <input checked="" type="checkbox"/> N/A The anchorage is not adjustable.  |
| <input checked="" type="checkbox"/> | 5.  | Buckle the seat belt. (S7.1.1.5(c)(1))  |
| <input checked="" type="checkbox"/> | 6.  | Locate a reference point A on the seat belt buckle. (S7.1.1.5(c)(2))  |
| <input checked="" type="checkbox"/> | 7.  | Locate a reference point B on the attachment hardware or retractor assembly at the other end of the lap belt or lap belt portion of the seat belt assembly. (S7.1.1.5(c)(2))  |
| <input checked="" type="checkbox"/> | 8.  | Does the vehicle user need to take some action to activate the locking feature on the lap belt portion of the seat belt in any forward-facing seat or seat that can be adjusted to forward-facing?  |
|                                     |     | <input checked="" type="checkbox"/> Yes (go to 8.1)   |
|                                     |     | <input type="checkbox"/> No (go to 9)   |
| <input checked="" type="checkbox"/> | 8.1 | Does the vehicle owner's manual include a description in words and/or diagrams describing how to activate the locking feature so that the seat belt assembly can tightly secure a child restraint system and how to deactivate the locking feature to remove the child restraint system. (S7.1.1.5(b))    |
|                                     |     | <input checked="" type="checkbox"/> Yes – Pass  |
|                                     |     | <input type="checkbox"/> No – Fail  |
| <input checked="" type="checkbox"/> | 9.  | Adjust the lap belt or lap belt portion of the seat belt assembly according to any procedures recommended in the vehicle owner's manual to activate any locking feature so that the webbing between points A and B is at the maximum length allowed by the belt system. (S7.1.1.5(c)(2) & S7.1.1.5(c)(1)) |

10. Measure and record the distance between points A and B along the longitudinal centerline of the webbing for the lap belt or lap belt portion of the seat belt assembly. (S7.1.1.5(c)(2))  
Measured distance between A and B (inches): 61
11. Readjust the belt system so that the webbing between points A and B is at ½ the maximum length of the webbing. (S7.1.1.5(c)(3))
12. To the lap belt or lap belt portion of the seat belt assembly, apply a preload of 10 pounds using the webbing tension pull device in Figure 5. Apply the load in a vertical plane parallel to the longitudinal axis of the vehicle and passing through the seating reference point of the designated seating position. Apply the preload in a horizontal direction toward the front of the vehicle with a force application angle of not less than 5 degrees nor more than 15 degrees above the horizontal. (S7.1.1.5(c)(4))  
Measured force application angle: 10° (spec. 5 - 15 degrees)
13. Measure the length between points A and B along the longitudinal centerline of the webbing while the preload is being applied. (S7.1.1.5(c)(4))  
Measured distance between A and B: 29 ¼ inches
14. Increase the load to 50 pounds at a rate of no more than 50 pounds per second. Attain the load in not more than 5 seconds. (If webbing sensitive emergency locking retractors are installed as part of the lap belt or lap belt portion of the seat belt assembly, apply the load at a rate less than the threshold value for lock-up specified by the manufacturer.) Maintain the load for at least 5 seconds. Measure and record the distance between points A and B along the longitudinal centerline of the webbing. (S7.1.1.5(c)(5))  
Record onset rate: 15 lb/sec (spec. 10 to 50 lb/sec) (S7.1.1.5(c)(5))  
Measured distance between A and B: 30 ¼ inches (S7.1.1.5(c)(6))
15. Let the seat belt webbing retract to its minimum length with the seat belt still buckled.
16. To the lap belt or lap belt portion of the seat belt assembly, apply a preload of 10 pounds using the webbing tension pull device in Figure 5. Apply the load in a vertical plane parallel to the longitudinal axis of the vehicle and passing through the seating reference point of the designated seating position. Apply the preload in a horizontal direction toward the front of the vehicle with a force application angle of not less than 5 degrees nor more than 15 degrees above the horizontal. (S7.1.1.5(c)(4))  
Measured force application angle: 10° (spec. 5 - 15 degrees)
17. Measure the length between points A and B along the longitudinal centerline of the webbing while the preload is being applied. (S7.1.1.5(c)(4))  
Measured distance between A and B: 11 ¼ inches
18. Increase the load to 50 pounds at a rate of no more than 50 pounds per second. Attain the load in not more than 5 seconds. (If webbing sensitive emergency locking retractors are installed as part of the lap belt or lap belt portion of the seat belt assembly, apply the load at a rate less than the threshold value for lock-up specified by the manufacturer.) Maintain the load for at least 5 seconds. Measure and record the distance between points A and B along the longitudinal centerline of the webbing. (S7.1.1.5(c)(5))  
Record onset rate: 15 lb/sec (spec. 10 to 50 lb/sec) (S7.1.1.5(c)(5))  
Measured distance between A and B: 12 ¾ inches (S7.1.1.5(c)(6))
19. Subtract the measurement in 13 from the measurement in 14 and the measurement in 17 from the measurement in 18. Is the difference 2 inches or less for both? (S7.1.1.5(c)(7))  
14 – 13 = 30 ¼ – 29 ¼ = 1 inch;  
18 – 17 = 12 ¾ – 11 ¼ = 1 ½ inch
- Yes – Pass  
 No – Fail

20. Subtract the measurement in 14 from the measurement in 10 and the measurement in 18 from the measurement in 10. Is the difference 3 inches or more for both?  
(S7.1.1.5(c)(8))

$10-14 = 61 - 30 \frac{1}{4} = 30 \frac{3}{4}$  inches;

$10-18 = 61 - 12 \frac{3}{4} = 48 \frac{1}{4}$  inches

Yes – Pass

No – Fail

REMARKS:

Signature: 

Date: 2/24/23

I certify that I have read and performed each instruction.

**DATA SHEET 8**  
**LAP BELT LOCKABILITY**

**Passenger cars, trucks, buses, and multipurpose passenger  
Vehicles with a GVWR of 10,000 pounds or less. (S7.1.1.5)**

Test Vehicle: 2023 Volvo XC40  
 Test Program: FMVSS 208 Compliance  
 Test Technician: Jose Galvez

NHTSA No.: C20235900  
 Test Date: 2/24/23

Complete one of these forms for **each** designated seating position that can be adjusted to forward-facing or that is a forward-facing seat, other than the driver's seat (S7.1.1.5(a), **and** that has seat belt retractors that are not solely automatic locking retractors. (S7.1.1.5(c))

DESIGNATED SEATING POSITION:	Center Rear Passenger
------------------------------	-----------------------

- N/A – No retractor is at this position
- N/A – The retractor is an automatic locking retractor ONLY
- 1. Record test fore-aft seat position: **FIXED**  
(S7.1.1.5(c)(1)) (Any position is acceptable)
- 2. Does the lap belt portion of the seat belt in the forward-facing seat or seat that can be adjusted to forward-facing consist of a locking device that does **NOT** have to be attached by the vehicle user to the seat belt webbing, retractor, or any other part of the vehicle. (S7.1.1.5(a))
  - Yes – Pass
  - No – Fail
- 3. Does the lap belt portion of the seat belt in the forward-facing seat or seat that can be adjusted to forward-facing consist of a locking device that does **NOT** require inverting, twisting or deforming of the belt webbing. (S7.1.1.5(a))
  - Yes – Pass
  - No – Fail
- 4. Place any adjustable seat belt anchorage in the lowest adjustment position.
  - N/A The anchorage is not adjustable.
- 5. Buckle the seat belt. (S7.1.1.5(c)(1))
- 6. Locate a reference point A on the seat belt buckle. (S7.1.1.5(c)(2))
- 7. Locate a reference point B on the attachment hardware or retractor assembly at the other end of the lap belt or lap belt portion of the seat belt assembly. (S7.1.1.5(c)(2))
- 8. Does the vehicle user need to take some action to activate the locking feature on the lap belt portion of the seat belt in any forward-facing seat or seat that can be adjusted to forward-facing?
  - Yes (go to 8.1)
  - No (go to 9)
- 8.1 Does the vehicle owner's manual include a description in words and/or diagrams describing how to activate the locking feature so that the seat belt assembly can tightly secure a child restraint system and how to deactivate the locking feature to remove the child restraint system. (S7.1.1.5(b))
  - Yes – Pass
  - No – Fail
- 9. Adjust the lap belt or lap belt portion of the seat belt assembly according to any procedures recommended in the vehicle owner's manual to activate any locking feature so that the webbing between points A and B is at the maximum length allowed by the belt system. (S7.1.1.5(c)(2) & S7.1.1.5(c)(1))

10. Measure and record the distance between points A and B along the longitudinal centerline of the webbing for the lap belt or lap belt portion of the seat belt assembly. (S7.1.1.5(c)(2))  
Measured distance between A and B (inches): 77
11. Readjust the belt system so that the webbing between points A and B is at ½ the maximum length of the webbing. (S7.1.1.5(c)(3))
12. To the lap belt or lap belt portion of the seat belt assembly, apply a preload of 10 pounds using the webbing tension pull device in Figure 5. Apply the load in a vertical plane parallel to the longitudinal axis of the vehicle and passing through the seating reference point of the designated seating position. Apply the preload in a horizontal direction toward the front of the vehicle with a force application angle of not less than 5 degrees nor more than 15 degrees above the horizontal. (S7.1.1.5(c)(4))  
Measured force application angle: 10° (spec. 5 - 15 degrees)
13. Measure the length between points A and B along the longitudinal centerline of the webbing while the preload is being applied. (S7.1.1.5(c)(4))  
Measured distance between A and B: 37 ¾ inches
14. Increase the load to 50 pounds at a rate of no more than 50 pounds per second. Attain the load in not more than 5 seconds. (If webbing sensitive emergency locking retractors are installed as part of the lap belt or lap belt portion of the seat belt assembly, apply the load at a rate less than the threshold value for lock-up specified by the manufacturer.) Maintain the load for at least 5 seconds. Measure and record the distance between points A and B along the longitudinal centerline of the webbing. (S7.1.1.5(c)(5))  
Record onset rate: 15 lb/sec (spec. 10 to 50 lb/sec) (S7.1.1.5(c)(5))  
Measured distance between A and B: 38 ¾ inches (S7.1.1.5(c)(6))
15. Let the seat belt webbing retract to its minimum length with the seat belt still buckled.
16. To the lap belt or lap belt portion of the seat belt assembly, apply a preload of 10 pounds using the webbing tension pull device in Figure 5. Apply the load in a vertical plane parallel to the longitudinal axis of the vehicle and passing through the seating reference point of the designated seating position. Apply the preload in a horizontal direction toward the front of the vehicle with a force application angle of not less than 5 degrees nor more than 15 degrees above the horizontal. (S7.1.1.5(c)(4))  
Measured force application angle: 10° (spec. 5 - 15 degrees)
17. Measure the length between points A and B along the longitudinal centerline of the webbing while the preload is being applied. (S7.1.1.5(c)(4))  
Measured distance between A and B: 7 ½ inches
18. Increase the load to 50 pounds at a rate of no more than 50 pounds per second. Attain the load in not more than 5 seconds. (If webbing sensitive emergency locking retractors are installed as part of the lap belt or lap belt portion of the seat belt assembly, apply the load at a rate less than the threshold value for lock-up specified by the manufacturer.) Maintain the load for at least 5 seconds. Measure and record the distance between points A and B along the longitudinal centerline of the webbing. (S7.1.1.5(c)(5))  
Record onset rate: 15 lb/sec (spec. 10 to 50 lb/sec) (S7.1.1.5(c)(5))  
Measured distance between A and B: 8 ¼ inches (S7.1.1.5(c)(6))
19. Subtract the measurement in 13 from the measurement in 14 and the measurement in 17 from the measurement in 18. Is the difference 2 inches or less for both? (S7.1.1.5(c)(7))  
14 – 13 = 38 ¾ - 37 ¾ = 1 inch;  
18 – 17 = 8 ¼ - 7 ½ = ¾ inch
- Yes – Pass  
 No – Fail

20. Subtract the measurement in 14 from the measurement in 10 and the measurement in 18 from the measurement in 10. Is the difference 3 inches or more for both?  
(S7.1.1.5(c)(8))

$10-14 = 77 - 38 \frac{3}{4} = 38 \frac{1}{4}$  inches;

$10-18 = 77 - 8 \frac{1}{4} = 68 \frac{3}{4}$  inches

Yes – Pass

No – Fail

REMARKS:

Signature: 

Date: 2/24/23

I certify that I have read and performed each instruction.

**DATA SHEET 8**  
**LAP BELT LOCKABILITY**

**Passenger cars, trucks, buses, and multipurpose passenger  
Vehicles with a GVWR of 10,000 pounds or less. (S7.1.1.5)**

Test Vehicle: 2023 Volvo XC40  
Test Program: FMVSS 208 Compliance  
Test Technician: Jose Galvez

NHTSA No.: C20235900  
Test Date: 2/24/23

Complete one of these forms for **each** designated seating position that can be adjusted to forward-facing or that is a forward-facing seat, other than the driver's seat (S7.1.1.5(a), **and** that has seat belt retractors that are not solely automatic locking retractors. (S7.1.1.5(c))

DESIGNATED SEATING POSITION:	Right Rear Passenger
------------------------------	----------------------

- |                                     |     |   |
|-------------------------------------|-----|---|
| <input type="checkbox"/>            |     | N/A – No retractor is at this position  |
| <input type="checkbox"/>            |     | N/A – The retractor is an automatic locking retractor ONLY  |
| <input checked="" type="checkbox"/> | 1.  | Record test fore-aft seat position: <b>FIXED</b><br>(S7.1.1.5(c)(1)) (Any position is acceptable)   |
| <input checked="" type="checkbox"/> | 2.  | Does the lap belt portion of the seat belt in the forward-facing seat or seat that can be adjusted to forward-facing consist of a locking device that does <b>NOT</b> have to be attached by the vehicle user to the seat belt webbing, retractor, or any other part of the vehicle. (S7.1.1.5(a))        |
|                                     |     | <input checked="" type="checkbox"/> Yes – Pass  |
|                                     |     | <input type="checkbox"/> No – Fail  |
| <input checked="" type="checkbox"/> | 3.  | Does the lap belt portion of the seat belt in the forward-facing seat or seat that can be adjusted to forward-facing consist of a locking device that does <b>NOT</b> require inverting, twisting or deforming of the belt webbing. (S7.1.1.5(a))   |
|                                     |     | <input checked="" type="checkbox"/> Yes – Pass  |
|                                     |     | <input type="checkbox"/> No – Fail  |
| <input checked="" type="checkbox"/> | 4.  | Place any adjustable seat belt anchorage in the lowest adjustment position.   |
|                                     |     | <input checked="" type="checkbox"/> N/A The anchorage is not adjustable.  |
| <input checked="" type="checkbox"/> | 5.  | Buckle the seat belt. (S7.1.1.5(c)(1))  |
| <input checked="" type="checkbox"/> | 6.  | Locate a reference point A on the seat belt buckle. (S7.1.1.5(c)(2))  |
| <input checked="" type="checkbox"/> | 7.  | Locate a reference point B on the attachment hardware or retractor assembly at the other end of the lap belt or lap belt portion of the seat belt assembly. (S7.1.1.5(c)(2))  |
| <input checked="" type="checkbox"/> | 8.  | Does the vehicle user need to take some action to activate the locking feature on the lap belt portion of the seat belt in any forward-facing seat or seat that can be adjusted to forward-facing?  |
|                                     |     | <input checked="" type="checkbox"/> Yes (go to 8.1)   |
|                                     |     | <input type="checkbox"/> No (go to 9)   |
| <input checked="" type="checkbox"/> | 8.1 | Does the vehicle owner's manual include a description in words and/or diagrams describing how to activate the locking feature so that the seat belt assembly can tightly secure a child restraint system and how to deactivate the locking feature to remove the child restraint system. (S7.1.1.5(b))    |
|                                     |     | <input checked="" type="checkbox"/> Yes – Pass  |
|                                     |     | <input type="checkbox"/> No – Fail  |
| <input checked="" type="checkbox"/> | 9.  | Adjust the lap belt or lap belt portion of the seat belt assembly according to any procedures recommended in the vehicle owner's manual to activate any locking feature so that the webbing between points A and B is at the maximum length allowed by the belt system. (S7.1.1.5(c)(2) & S7.1.1.5(c)(1)) |

10. Measure and record the distance between points A and B along the longitudinal centerline of the webbing for the lap belt or lap belt portion of the seat belt assembly. (S7.1.1.5(c)(2))  
Measured distance between A and B (inches): 61
11. Readjust the belt system so that the webbing between points A and B is at ½ the maximum length of the webbing. (S7.1.1.5(c)(3))
12. To the lap belt or lap belt portion of the seat belt assembly, apply a preload of 10 pounds using the webbing tension pull device in Figure 5. Apply the load in a vertical plane parallel to the longitudinal axis of the vehicle and passing through the seating reference point of the designated seating position. Apply the preload in a horizontal direction toward the front of the vehicle with a force application angle of not less than 5 degrees nor more than 15 degrees above the horizontal. (S7.1.1.5(c)(4))  
Measured force application angle: 10° (spec. 5 - 15 degrees)
13. Measure the length between points A and B along the longitudinal centerline of the webbing while the preload is being applied. (S7.1.1.5(c)(4))  
Measured distance between A and B: 29 ¾ inches
14. Increase the load to 50 pounds at a rate of no more than 50 pounds per second. Attain the load in not more than 5 seconds. (If webbing sensitive emergency locking retractors are installed as part of the lap belt or lap belt portion of the seat belt assembly, apply the load at a rate less than the threshold value for lock-up specified by the manufacturer.) Maintain the load for at least 5 seconds. Measure and record the distance between points A and B along the longitudinal centerline of the webbing. (S7.1.1.5(c)(5))  
Record onset rate: 15 lb/sec (spec. 10 to 50 lb/sec) (S7.1.1.5(c)(5))  
Measured distance between A and B: 30 ¾ inches (S7.1.1.5(c)(6))
15. Let the seat belt webbing retract to its minimum length with the seat belt still buckled.
16. To the lap belt or lap belt portion of the seat belt assembly, apply a preload of 10 pounds using the webbing tension pull device in Figure 5. Apply the load in a vertical plane parallel to the longitudinal axis of the vehicle and passing through the seating reference point of the designated seating position. Apply the preload in a horizontal direction toward the front of the vehicle with a force application angle of not less than 5 degrees nor more than 15 degrees above the horizontal. (S7.1.1.5(c)(4))  
Measured force application angle: 10° (spec. 5 - 15 degrees)
17. Measure the length between points A and B along the longitudinal centerline of the webbing while the preload is being applied. (S7.1.1.5(c)(4))  
Measured distance between A and B: 11 inches
18. Increase the load to 50 pounds at a rate of no more than 50 pounds per second. Attain the load in not more than 5 seconds. (If webbing sensitive emergency locking retractors are installed as part of the lap belt or lap belt portion of the seat belt assembly, apply the load at a rate less than the threshold value for lock-up specified by the manufacturer.) Maintain the load for at least 5 seconds. Measure and record the distance between points A and B along the longitudinal centerline of the webbing. (S7.1.1.5(c)(5))  
Record onset rate: 15 lb/sec (spec. 10 to 50 lb/sec) (S7.1.1.5(c)(5))  
Measured distance between A and B: 12 inches (S7.1.1.5(c)(6))
19. Subtract the measurement in 13 from the measurement in 14 and the measurement in 17 from the measurement in 18. Is the difference 2 inches or less for both? (S7.1.1.5(c)(7))
- 14 – 13 = 30 ¾ - 29 ¾ = 1 inch;  
 18 – 17 = 12 - 11 = 1 inch;
- Yes – Pass  
 No – Fail

20. Subtract the measurement in 14 from the measurement in 10 and the measurement in 18 from the measurement in 10. Is the difference 3 inches or more for both?  
(S7.1.1.5(c)(8))

$10-14 = 61 - 30 \frac{3}{4} = 30 \frac{1}{4}$  inches;

$10-18 = 61 - 12 = 49$  inches

Yes – Pass

No – Fail

REMARKS:

Signature: 

Date: 2/24/23

I certify that I have read and performed each instruction.

**DATA SHEET 9**

**FMVSS 208 SEAT BELT WARNING SYSTEM CHECK (S7.3)**

Test Vehicle: 2023 Volvo XC40  
 Test Program: FMVSS 208 Compliance  
 Test Technician: Jose Galvez

NHTSA No.: C20235900  
 Test Date: 2/24/23

- 1. The occupant is in the driver's seat.
- 2. The seat belt is in the stowed position.
- 3. The key is in the "on" or "start" position.
- 4. The time duration of the audible signal beginning with key "on" or "start" is 7 seconds.
- 5. The occupant is in the driver's seat.
- 6. The seat belt is in the stowed position.
- 7. The key is in the "on" or "start" position.
- 8. The time duration of the warning light beginning with key "on" or "start" is Stays On seconds.
- 9. The occupant is in the driver's seat.
- 10. The seat belt is in the latched position and with at least 4 inches of belt webbing extended.
- 11. The key is in the "on" or "start" position.
- 12. The time duration of the warning light beginning with key "on" or "start" is 0 seconds.
- 13. Complete the following table with the data from 4, 8, and 12 to determine which option is used.

		Warning light	Warning light specification	Audible signal	Audible signal specification*
S7.3 (a)(1)	Belt stowed & key on or start	Item 8: <u>Stays On</u>	60 seconds minimum	Item 4: <u>7</u>	4 to 8 seconds
S7.3 (a)(2)	Belt latched & key on or start	Item 12: <u>0</u>	4 to 8 seconds		
	Belt stowed & key on or start	Item 8: <u>Stays On</u>	4 to 8 seconds	Item 4: <u>7</u>	4 to 8 seconds

\* 49 USCS @ 30124 does NOT allow an audible signal to operate for more than 8 seconds.

A voluntary audible signal after the 4 to 8 second required signal may be provided. It must be differentiated from the required signal (5/25/2001 legal interpretation to Longacre and Associates).

- 14. The seat belt warning system meets the requirements of (manufacturers may comply with either section).
  - S7.3 (a)(1)
  - S7.3 (a)(2)
  - FAIL – Does NOT meet the requirements of either option.
- 15. Note wording of visual warning: (S7.3(a)(1) and S7.3(a)(2))
  - Fasten Seat Belts
  - Fasten Belts
  - Symbol 101 - 
  - FAIL – Does not use any of the above wording or symbol.

**REMARKS:**

I certify that I have read and performed each instruction.

Signature: 

Date: 2/24/23

**DATA SHEET 10**  
**BELT CONTACT FORCE (S7.4.3)**

Test Vehicle: 2023 Volvo XC40  
 Test Program: FMVSS 208 Compliance  
 Test Technician: Jose Galvez

NHTSA No.: C20235900  
 Test Date: 2/24/23

Test all Type 2 seat belts other than those in walk-in van-type vehicles and those at front outboard designated seating positions in passenger cars. Complete a form for each applicable seat belt.

DESIGNATED SEATING POSITION:	Left Front Driver
------------------------------	-------------------

- |                                     |    |   |
|-------------------------------------|----|---|
| <input checked="" type="checkbox"/> | 1. | Does the vehicle incorporate a webbing tension-relieving device?        |
|                                     |    | <input type="checkbox"/> Yes (this form is complete)                    |
|                                     |    | <input checked="" type="checkbox"/> No (continue with this check sheet) |
- |                                     |    |   |
|-------------------------------------|----|---|
| <input checked="" type="checkbox"/> | 2. | Position the seat's adjustable lumbar supports so that the lumbar support is in its lowest, retracted or deflated adjustment position. (S8.1.3) |
|                                     |    | <input type="checkbox"/> N/A – No lumbar adjustment   |
- |                                     |    |   |
|-------------------------------------|----|---|
| <input checked="" type="checkbox"/> | 3. | Position any adjustable parts of the seat that provide additional support so that they are in the lowest or most open adjustment position. (S16.2.10.2) |
|                                     |    | <input checked="" type="checkbox"/> N/A – No additional support adjustment  |
- |                                     |    |   |
|-------------------------------------|----|---|
| <input checked="" type="checkbox"/> | 4. | Is the fore-aft position of the seat adjustable?    |
|                                     |    | <input type="checkbox"/> No – go to 5               |
|                                     |    | <input checked="" type="checkbox"/> Yes – go to 4.1 |
- |                                     |     |   |
|-------------------------------------|-----|---|
| <input checked="" type="checkbox"/> | 4.1 | Use all the seat controls that have any affect on the fore-aft movement of the seat to move the seat cushion to the rearmost position. <b>Mark</b> this position. (8/31/95 legal interpretation to Hogan and Hartson) |
|-------------------------------------|-----|---|
- |                                     |     |  |
|-------------------------------------|-----|--|
| <input checked="" type="checkbox"/> | 4.2 | Use all the seat controls that have any affects on the fore-aft movement of the seat to move the seat cushion to the foremost position. <b>Mark</b> this position. (8/31/95 legal interpretation to Hogan and Hartson) |
|-------------------------------------|-----|--|
- |                                     |     |   |
|-------------------------------------|-----|---|
| <input checked="" type="checkbox"/> | 4.3 | <b>Mark</b> each fore-aft position so that there is a visual indication when the seat is at a particular position. For manual seats, <b>mark</b> each detent. For power seats, mark only the rearmost, middle and foremost positions. Label three of the positions with the following: F for foremost, M for mid-position (if there is no mid-position, label the closest adjustment position to the rear of the mid-point), and R for rearmost. Determine the mid fore-aft seat position based on the foremost and rearmost positions determined in items 4.1 and 4.2. (8/31/95 legal interpretation to Hogan and Hartson) |
|-------------------------------------|-----|---|
- |                                     |     |                                    |
|-------------------------------------|-----|------------------------------------|
| <input checked="" type="checkbox"/> | 4.4 | Move the seat to the mid position. |
|-------------------------------------|-----|------------------------------------|
- |                                     |     |  |
|-------------------------------------|-----|--|
| <input checked="" type="checkbox"/> | 4.5 | While maintaining the mid position, move the seat to its lowest position. For seats with adjustable seat cushions, use the manufacturer's recommended seat cushion angle for determining the lowest height position. |
|-------------------------------------|-----|--|
- |                                     |    |  |
|-------------------------------------|----|--|
| <input checked="" type="checkbox"/> | 5. | Is the seat back angle adjustable?                 |
|                                     |    | <input type="checkbox"/> No- go to 6               |
|                                     |    | <input checked="" type="checkbox"/> Yes- go to 5.1 |
- |                                     |     |   |
|-------------------------------------|-----|---|
| <input checked="" type="checkbox"/> | 5.1 | Set and mark seat back angle, if adjustable, at the manufacturer's nominal design riding position for a 50 <sup>th</sup> percentile adult male in the manner specified by the manufacturer. |
|                                     |     | <input type="checkbox"/> N/A – No seat back angle adjustment  |
|                                     |     | <input checked="" type="checkbox"/> Manufacturer's design seat back angle: <u>20.0° on the Seat Back</u>  |
|                                     |     | <input checked="" type="checkbox"/> Tested seat back angle: <u>20.0° on the Seat Back</u>   |

6. Is the seat a bucket seat?  
 Yes, go to 6.1 and skip 6.2  
 No, go to 6.2 and skip 6.1
- 6.1 Bucket seats:  
 Locate and mark the longitudinal centerline of the seat cushion. The intersection of the vertical longitudinal plane that passes through the SgRP and the seat cushion upper surface determines the longitudinal centerline of a bucket seat cushion. (S10.4.1.2 and S16.3.1.10)
- 6.2 Bench seats (complete ONLY the one that is applicable to the seat being tested):
- 6.2.1 Driver Seat  
 Locate and **mark** the longitudinal line on the seat cushion that marks the intersection of the vertical longitudinal plane through the centerline of the steering wheel and the seat cushion upper surface. (S10.4.1.1)
- 6.2.2 Front Outboard Passenger Seat  
 Locate and **mark** the longitudinal centerline of the passenger seat cushion. The longitudinal centerline is the same distance from the longitudinal centerline of the vehicle as the center of the steering wheel. (S10.4.1.1)  
 Record the distance from the longitudinal centerline of the vehicle to the center of the steering wheel. \_\_\_\_\_  
 Record the distance from the longitudinal centerline of the vehicle to the longitudinal centerline of the seat cushion. \_\_\_\_\_
- 6.2.3 Rear designated seating positions  
 Locate and **mark** the longitudinal centerline of the seat cushion. The intersection of the vertical longitudinal plane that passes through the SgRP and the seat cushion upper surface determines the longitudinal centerline.
7. Position the test dummies according to dummy position placement instructions in Appendix F. **Complete the Appendix F check sheets, but include them in the test report ONLY if there is a test failure.**
8. Fasten the seat belt latch.
9. Pull either 12 inches of belt webbing or the maximum available amount of belt webbing, whichever is less, from the retractor and then release it, allowing the belt webbing to return to the dummy's chest.
10. Locate the point where the centerline of the upper torso belt webbing crosses the midsagittal line on the dummy's chest. At that point pull the belt webbing out 3 inches from the dummy's chest and release until it is within one inch from the dummy's chest. (S10.8) Using a force measuring gage with a full scale range of no more than 1.5 pounds, measure the contact force perpendicular to the dummy's chest exerted by the belt webbing.  
 Contact Force (lb): **0.7**  
 0.0 to 0.7 pounds – Pass  
 **Greater than 0.7 pounds - FAIL**

REMARKS:

Signature: 

Date: 2/24/23

I certify that I have read and performed each instruction.

**DATA SHEET 10**  
**BELT CONTACT FORCE (S7.4.3)**

Test Vehicle: 2023 Volvo XC40  
 Test Program: FMVSS 208 Compliance  
 Test Technician: Jose Galvez

NHTSA No.: C20235900  
 Test Date: 2/24/23

Test all Type 2 seat belts other than those in walk-in van-type vehicles and those at front outboard designated seating positions in passenger cars. Complete a form for each applicable seat belt.

DESIGNATED SEATING POSITION:	Right Front Passenger
------------------------------	-----------------------

- |                                     |    |   |
|-------------------------------------|----|---|
| <input checked="" type="checkbox"/> | 1. | Does the vehicle incorporate a webbing tension-relieving device?        |
|                                     |    | <input type="checkbox"/> Yes (this form is complete)                    |
|                                     |    | <input checked="" type="checkbox"/> No (continue with this check sheet) |
- |                                     |    |   |
|-------------------------------------|----|---|
| <input checked="" type="checkbox"/> | 2. | Position the seat's adjustable lumbar supports so that the lumbar support is in its lowest, retracted or deflated adjustment position. (S8.1.3) |
|                                     |    | <input type="checkbox"/> N/A – No lumbar adjustment   |
- |                                     |    |   |
|-------------------------------------|----|---|
| <input checked="" type="checkbox"/> | 3. | Position any adjustable parts of the seat that provide additional support so that they are in the lowest or most open adjustment position. (S16.2.10.2) |
|                                     |    | <input checked="" type="checkbox"/> N/A – No additional support adjustment  |
- |                                     |    |   |
|-------------------------------------|----|---|
| <input checked="" type="checkbox"/> | 4. | Is the fore-aft position of the seat adjustable?    |
|                                     |    | <input type="checkbox"/> No – go to 5               |
|                                     |    | <input checked="" type="checkbox"/> Yes – go to 4.1 |
- |                                     |     |   |
|-------------------------------------|-----|---|
| <input checked="" type="checkbox"/> | 4.1 | Use all the seat controls that have any effect on the fore-aft movement of the seat to move the seat cushion to the rearmost position. <b>Mark</b> this position. (8/31/95 legal interpretation to Hogan and Hartson) |
|-------------------------------------|-----|---|
- |                                     |     |  |
|-------------------------------------|-----|--|
| <input checked="" type="checkbox"/> | 4.2 | Use all the seat controls that have any effects on the fore-aft movement of the seat to move the seat cushion to the foremost position. <b>Mark</b> this position. (8/31/95 legal interpretation to Hogan and Hartson) |
|-------------------------------------|-----|--|
- |                                     |     |   |
|-------------------------------------|-----|---|
| <input checked="" type="checkbox"/> | 4.3 | <b>Mark</b> each fore-aft position so that there is a visual indication when the seat is at a particular position. For manual seats, <b>mark</b> each detent. For power seats, mark only the rearmost, middle and foremost positions. Label three of the positions with the following: F for foremost, M for mid-position (if there is no mid-position, label the closest adjustment position to the rear of the mid-point), and R for rearmost. Determine the mid fore-aft seat position based on the foremost and rearmost positions determined in items 4.1 and 4.2. (8/31/95 legal interpretation to Hogan and Hartson) |
|-------------------------------------|-----|---|
- |                                     |     |                                    |
|-------------------------------------|-----|------------------------------------|
| <input checked="" type="checkbox"/> | 4.4 | Move the seat to the mid position. |
|-------------------------------------|-----|------------------------------------|
- |                                     |     |  |
|-------------------------------------|-----|--|
| <input checked="" type="checkbox"/> | 4.5 | While maintaining the mid position, move the seat to its lowest position. For seats with adjustable seat cushions, use the manufacturer's recommended seat cushion angle for determining the lowest height position. |
|-------------------------------------|-----|--|
- |                                     |    |  |
|-------------------------------------|----|--|
| <input checked="" type="checkbox"/> | 5. | Is the seat back angle adjustable?                 |
|                                     |    | <input type="checkbox"/> No- go to 6               |
|                                     |    | <input checked="" type="checkbox"/> Yes- go to 5.1 |
- |                                     |     |   |
|-------------------------------------|-----|---|
| <input checked="" type="checkbox"/> | 5.1 | Set and mark seat back angle, if adjustable, at the manufacturer's nominal design riding position for a 50 <sup>th</sup> percentile adult male in the manner specified by the manufacturer. |
|                                     |     | <input type="checkbox"/> N/A – No seat back angle adjustment  |
|                                     |     | <input checked="" type="checkbox"/> Manufacturer's design seat back angle: <u>20.0° on the Seat Back</u>  |
|                                     |     | <input checked="" type="checkbox"/> Tested seat back angle: <u>20.0° on the Seat Back</u>   |

6. Is the seat a bucket seat?  
 Yes, go to 6.1 and skip 6.2  
 No, go to 6.2 and skip 6.1
- 6.1 Bucket seats:  
 Locate and mark the longitudinal centerline of the seat cushion. The intersection of the vertical longitudinal plane that passes through the SgRP and the seat cushion upper surface determines the longitudinal centerline of a bucket seat cushion. (S10.4.1.2 and S16.3.1.10)
- 6.2 Bench seats (complete ONLY the one that is applicable to the seat being tested):
- 6.2.1 Driver Seat  
 Locate and **mark** the longitudinal line on the seat cushion that marks the intersection of the vertical longitudinal plane through the centerline of the steering wheel and the seat cushion upper surface. (S10.4.1.1)
- 6.2.2 Front Outboard Passenger Seat  
 Locate and **mark** the longitudinal centerline of the passenger seat cushion. The longitudinal centerline is the same distance from the longitudinal centerline of the vehicle as the center of the steering wheel. (S10.4.1.1)  
 Record the distance from the longitudinal centerline of the vehicle to the center of the steering wheel. \_\_\_\_\_  
 Record the distance from the longitudinal centerline of the vehicle to the longitudinal centerline of the seat cushion. \_\_\_\_\_
- 6.2.3 Rear designated seating positions  
 Locate and **mark** the longitudinal centerline of the seat cushion. The intersection of the vertical longitudinal plane that passes through the SgRP and the seat cushion upper surface determines the longitudinal centerline.
7. Position the test dummies according to dummy position placement instructions in Appendix F. **Complete the Appendix F check sheets, but include them in the test report ONLY if there is a test failure.**
8. Fasten the seat belt latch.
9. Pull either 12 inches of belt webbing or the maximum available amount of belt webbing, whichever is less, from the retractor and then release it, allowing the belt webbing to return to the dummy's chest.
10. Locate the point where the centerline of the upper torso belt webbing crosses the midsagittal line on the dummy's chest. At that point pull the belt webbing out 3 inches from the dummy's chest and release until it is within one inch from the dummy's chest. (S10.8) Using a force measuring gage with a full scale range of no more than 1.5 pounds, measure the contact force perpendicular to the dummy's chest exerted by the belt webbing.  
 Contact Force (lb): **0.7**  
 0.0 to 0.7 pounds – Pass  
 **Greater than 0.7 pounds - FAIL**

REMARKS:

Signature: 

Date: 2/24/23

I certify that I have read and performed each instruction.

**DATA SHEET 10**  
**BELT CONTACT FORCE (S7.4.3)**

Test Vehicle: 2023 Volvo XC40  
 Test Program: FMVSS 208 Compliance  
 Test Technician: Jose Galvez

NHTSA No.: C20235900  
 Test Date: 2/24/23

Test all Type 2 seat belts other than those in walk-in van-type vehicles and those at front outboard designated seating positions in passenger cars. Complete a form for each applicable seat belt.

DESIGNATED SEATING POSITION:	Left Rear Passenger
------------------------------	---------------------

- |                                     |    |   |
|-------------------------------------|----|---|
| <input checked="" type="checkbox"/> | 1. | Does the vehicle incorporate a webbing tension-relieving device?        |
|                                     |    | <input type="checkbox"/> Yes (this form is complete)                    |
|                                     |    | <input checked="" type="checkbox"/> No (continue with this check sheet) |
- |                                     |    |   |
|-------------------------------------|----|---|
| <input checked="" type="checkbox"/> | 2. | Position the seat's adjustable lumbar supports so that the lumbar support is in its lowest, retracted or deflated adjustment position. (S8.1.3) |
|                                     |    | <input checked="" type="checkbox"/> N/A – No lumbar adjustment  |
- |                                     |    |   |
|-------------------------------------|----|---|
| <input checked="" type="checkbox"/> | 3. | Position any adjustable parts of the seat that provide additional support so that they are in the lowest or most open adjustment position. (S16.2.10.2) |
|                                     |    | <input checked="" type="checkbox"/> N/A – No additional support adjustment  |
- |                                     |    |  |
|-------------------------------------|----|--|
| <input checked="" type="checkbox"/> | 4. | Is the fore-aft position of the seat adjustable? |
|                                     |    | <input checked="" type="checkbox"/> No – go to 5 |
|                                     |    | <input type="checkbox"/> Yes – go to 4.1         |
- |                          |     |   |
|--------------------------|-----|---|
| <input type="checkbox"/> | 4.1 | Use all the seat controls that have any affect on the fore-aft movement of the seat to move the seat cushion to the rearmost position. <b>Mark</b> this position. (8/31/95 legal interpretation to Hogan and Hartson) |
|--------------------------|-----|---|
- |                          |     |  |
|--------------------------|-----|--|
| <input type="checkbox"/> | 4.2 | Use all the seat controls that have any affects on the fore-aft movement of the seat to move the seat cushion to the foremost position. <b>Mark</b> this position. (8/31/95 legal interpretation to Hogan and Hartson) |
|--------------------------|-----|--|
- |                          |     |   |
|--------------------------|-----|---|
| <input type="checkbox"/> | 4.3 | <b>Mark</b> each fore-aft position so that there is a visual indication when the seat is at a particular position. For manual seats, <b>mark</b> each detent. For power seats, mark only the rearmost, middle and foremost positions. Label three of the positions with the following: F for foremost, M for mid-position (if there is no mid-position, label the closest adjustment position to the rear of the mid-point), and R for rearmost. Determine the mid fore-aft seat position based on the foremost and rearmost positions determined in items 4.1 and 4.2. (8/31/95 legal interpretation to Hogan and Hartson) |
|--------------------------|-----|---|
- |                          |     |                                    |
|--------------------------|-----|------------------------------------|
| <input type="checkbox"/> | 4.4 | Move the seat to the mid position. |
|--------------------------|-----|------------------------------------|
- |                          |     |  |
|--------------------------|-----|--|
| <input type="checkbox"/> | 4.5 | While maintaining the mid position, move the seat to its lowest position. For seats with adjustable seat cushions, use the manufacturer's recommended seat cushion angle for determining the lowest height position. |
|--------------------------|-----|--|
- |                                     |    |   |
|-------------------------------------|----|---|
| <input checked="" type="checkbox"/> | 5. | Is the seat back angle adjustable?              |
|                                     |    | <input checked="" type="checkbox"/> No- go to 6 |
|                                     |    | <input type="checkbox"/> Yes- go to 5.1         |
- |                          |     |   |
|--------------------------|-----|---|
| <input type="checkbox"/> | 5.1 | Set and mark seat back angle, if adjustable, at the manufacturer's nominal design riding position for a 50 <sup>th</sup> percentile adult male in the manner specified by the manufacturer. |
|                          |     | <input type="checkbox"/> N/A – No seat back angle adjustment  |
|                          |     | <input type="checkbox"/> Manufacturer's design seat back angle: _____   |
|                          |     | <input type="checkbox"/> Tested seat back angle: _____  |

6. Is the seat a bucket seat?  
 Yes, go to 6.1 and skip 6.2  
 No, go to 6.2 and skip 6.1
- 6.1 Bucket seats:  
 Locate and mark the longitudinal centerline of the seat cushion. The intersection of the vertical longitudinal plane that passes through the SgRP and the seat cushion upper surface determines the longitudinal centerline of a bucket seat cushion. (S10.4.1.2 and S16.3.1.10)
- 6.2 Bench seats (complete ONLY the one that is applicable to the seat being tested):
- 6.2.1 Driver Seat  
 Locate and **mark** the longitudinal line on the seat cushion that marks the intersection of the vertical longitudinal plane through the centerline of the steering wheel and the seat cushion upper surface. (S10.4.1.1)
- 6.2.2 Front Outboard Passenger Seat  
 Locate and **mark** the longitudinal centerline of the passenger seat cushion. The longitudinal centerline is the same distance from the longitudinal centerline of the vehicle as the center of the steering wheel. (S10.4.1.1)  
 Record the distance from the longitudinal centerline of the vehicle to the center of the steering wheel. \_\_\_\_\_  
 Record the distance from the longitudinal centerline of the vehicle to the longitudinal centerline of the seat cushion. \_\_\_\_\_
- 6.2.3 Rear designated seating positions  
 Locate and **mark** the longitudinal centerline of the seat cushion. The intersection of the vertical longitudinal plane that passes through the SgRP and the seat cushion upper surface determines the longitudinal centerline.
7. Position the test dummies according to dummy position placement instructions in Appendix F. **Complete the Appendix F check sheets, but include them in the test report ONLY if there is a test failure.**
8. Fasten the seat belt latch.
9. Pull either 12 inches of belt webbing or the maximum available amount of belt webbing, whichever is less, from the retractor and then release it, allowing the belt webbing to return to the dummy's chest.
10. Locate the point where the centerline of the upper torso belt webbing crosses the midsagittal line on the dummy's chest. At that point pull the belt webbing out 3 inches from the dummy's chest and release until it is within one inch from the dummy's chest. (S10.8) Using a force measuring gage with a full scale range of no more than 1.5 pounds, measure the contact force perpendicular to the dummy's chest exerted by the belt webbing.  
 Contact Force (lb): **0.6**  
 0.0 to 0.7 pounds – Pass  
 **Greater than 0.7 pounds - FAIL**

REMARKS:

Signature: 

Date: 2/24/23

I certify that I have read and performed each instruction.

**DATA SHEET 10**  
**BELT CONTACT FORCE (S7.4.3)**

Test Vehicle: 2023 Volvo XC40  
 Test Program: FMVSS 208 Compliance  
 Test Technician: Jose Galvez

NHTSA No.: C20235900  
 Test Date: 2/24/23

Test all Type 2 seat belts other than those in walk-in van-type vehicles and those at front outboard designated seating positions in passenger cars. Complete a form for each applicable seat belt.

DESIGNATED SEATING POSITION:	Center Rear Passenger
------------------------------	-----------------------

- |                                     |    |   |
|-------------------------------------|----|---|
| <input checked="" type="checkbox"/> | 1. | Does the vehicle incorporate a webbing tension-relieving device?        |
|                                     |    | <input type="checkbox"/> Yes (this form is complete)                    |
|                                     |    | <input checked="" type="checkbox"/> No (continue with this check sheet) |
- |                                     |    |   |
|-------------------------------------|----|---|
| <input checked="" type="checkbox"/> | 2. | Position the seat's adjustable lumbar supports so that the lumbar support is in its lowest, retracted or deflated adjustment position. (S8.1.3) |
|                                     |    | <input checked="" type="checkbox"/> N/A – No lumbar adjustment  |
- |                                     |    |   |
|-------------------------------------|----|---|
| <input checked="" type="checkbox"/> | 3. | Position any adjustable parts of the seat that provide additional support so that they are in the lowest or most open adjustment position. (S16.2.10.2) |
|                                     |    | <input checked="" type="checkbox"/> N/A – No additional support adjustment  |
- |                                     |    |  |
|-------------------------------------|----|--|
| <input checked="" type="checkbox"/> | 4. | Is the fore-aft position of the seat adjustable? |
|                                     |    | <input checked="" type="checkbox"/> No – go to 5 |
|                                     |    | <input type="checkbox"/> Yes – go to 4.1         |
- |                          |     |   |
|--------------------------|-----|---|
| <input type="checkbox"/> | 4.1 | Use all the seat controls that have any affect on the fore-aft movement of the seat to move the seat cushion to the rearmost position. <b>Mark</b> this position. (8/31/95 legal interpretation to Hogan and Hartson) |
|--------------------------|-----|---|
- |                          |     |  |
|--------------------------|-----|--|
| <input type="checkbox"/> | 4.2 | Use all the seat controls that have any affects on the fore-aft movement of the seat to move the seat cushion to the foremost position. <b>Mark</b> this position. (8/31/95 legal interpretation to Hogan and Hartson) |
|--------------------------|-----|--|
- |                          |     |   |
|--------------------------|-----|---|
| <input type="checkbox"/> | 4.3 | <b>Mark</b> each fore-aft position so that there is a visual indication when the seat is at a particular position. For manual seats, <b>mark</b> each detent. For power seats, mark only the rearmost, middle and foremost positions. Label three of the positions with the following: F for foremost, M for mid-position (if there is no mid-position, label the closest adjustment position to the rear of the mid-point), and R for rearmost. Determine the mid fore-aft seat position based on the foremost and rearmost positions determined in items 4.1 and 4.2. (8/31/95 legal interpretation to Hogan and Hartson) |
|--------------------------|-----|---|
- |                          |     |                                    |
|--------------------------|-----|------------------------------------|
| <input type="checkbox"/> | 4.4 | Move the seat to the mid position. |
|--------------------------|-----|------------------------------------|
- |                          |     |  |
|--------------------------|-----|--|
| <input type="checkbox"/> | 4.5 | While maintaining the mid position, move the seat to its lowest position. For seats with adjustable seat cushions, use the manufacturer's recommended seat cushion angle for determining the lowest height position. |
|--------------------------|-----|--|
- |                                     |    |   |
|-------------------------------------|----|---|
| <input checked="" type="checkbox"/> | 5. | Is the seat back angle adjustable?              |
|                                     |    | <input checked="" type="checkbox"/> No- go to 6 |
|                                     |    | <input type="checkbox"/> Yes- go to 5.1         |
- |                          |     |   |
|--------------------------|-----|---|
| <input type="checkbox"/> | 5.1 | Set and mark seat back angle, if adjustable, at the manufacturer's nominal design riding position for a 50 <sup>th</sup> percentile adult male in the manner specified by the manufacturer. |
|                          |     | <input type="checkbox"/> N/A – No seat back angle adjustment  |
|                          |     | <input type="checkbox"/> Manufacturer's design seat back angle: _____   |
|                          |     | <input type="checkbox"/> Tested seat back angle: _____  |

6. Is the seat a bucket seat?  
 Yes, go to 6.1 and skip 6.2  
 No, go to 6.2 and skip 6.1
- 6.1 Bucket seats:  
 Locate and mark the longitudinal centerline of the seat cushion. The intersection of the vertical longitudinal plane that passes through the SgRP and the seat cushion upper surface determines the longitudinal centerline of a bucket seat cushion. (S10.4.1.2 and S16.3.1.10)
- 6.2 Bench seats (complete ONLY the one that is applicable to the seat being tested):
- 6.2.1 Driver Seat  
 Locate and **mark** the longitudinal line on the seat cushion that marks the intersection of the vertical longitudinal plane through the centerline of the steering wheel and the seat cushion upper surface. (S10.4.1.1)
- 6.2.2 Front Outboard Passenger Seat  
 Locate and **mark** the longitudinal centerline of the passenger seat cushion. The longitudinal centerline is the same distance from the longitudinal centerline of the vehicle as the center of the steering wheel. (S10.4.1.1)  
 Record the distance from the longitudinal centerline of the vehicle to the center of the steering wheel. \_\_\_\_\_  
 Record the distance from the longitudinal centerline of the vehicle to the longitudinal centerline of the seat cushion. \_\_\_\_\_
- 6.2.3 Rear designated seating positions  
 Locate and **mark** the longitudinal centerline of the seat cushion. The intersection of the vertical longitudinal plane that passes through the SgRP and the seat cushion upper surface determines the longitudinal centerline.
7. Position the test dummies according to dummy position placement instructions in Appendix F. **Complete the Appendix F check sheets, but include them in the test report ONLY if there is a test failure.**
8. Fasten the seat belt latch.
9. Pull either 12 inches of belt webbing or the maximum available amount of belt webbing, whichever is less, from the retractor and then release it, allowing the belt webbing to return to the dummy's chest.
10. Locate the point where the centerline of the upper torso belt webbing crosses the midsagittal line on the dummy's chest. At that point pull the belt webbing out 3 inches from the dummy's chest and release until it is within one inch from the dummy's chest. (S10.8) Using a force measuring gage with a full scale range of no more than 1.5 pounds, measure the contact force perpendicular to the dummy's chest exerted by the belt webbing.  
 Contact Force (lb): **0.6**  
 0.0 to 0.7 pounds – Pass  
 **Greater than 0.7 pounds - FAIL**

REMARKS:

Signature: 

Date: 2/24/23

I certify that I have read and performed each instruction.

**DATA SHEET 10**  
**BELT CONTACT FORCE (S7.4.3)**

Test Vehicle: 2023 Volvo XC40  
 Test Program: FMVSS 208 Compliance  
 Test Technician: Jose Galvez

NHTSA No.: C20235900  
 Test Date: 2/24/23

Test all Type 2 seat belts other than those in walk-in van-type vehicles and those at front outboard designated seating positions in passenger cars. Complete a form for each applicable seat belt.

DESIGNATED SEATING POSITION:	Right Rear Passenger
------------------------------	----------------------

- |                                     |    |   |
|-------------------------------------|----|---|
| <input checked="" type="checkbox"/> | 1. | Does the vehicle incorporate a webbing tension-relieving device?        |
|                                     |    | <input type="checkbox"/> Yes (this form is complete)                    |
|                                     |    | <input checked="" type="checkbox"/> No (continue with this check sheet) |
- |                                     |    |   |
|-------------------------------------|----|---|
| <input checked="" type="checkbox"/> | 2. | Position the seat's adjustable lumbar supports so that the lumbar support is in its lowest, retracted or deflated adjustment position. (S8.1.3) |
|                                     |    | <input checked="" type="checkbox"/> N/A – No lumbar adjustment  |
- |                                     |    |   |
|-------------------------------------|----|---|
| <input checked="" type="checkbox"/> | 3. | Position any adjustable parts of the seat that provide additional support so that they are in the lowest or most open adjustment position. (S16.2.10.2) |
|                                     |    | <input checked="" type="checkbox"/> N/A – No additional support adjustment  |
- |                                     |    |  |
|-------------------------------------|----|--|
| <input checked="" type="checkbox"/> | 4. | Is the fore-aft position of the seat adjustable? |
|                                     |    | <input checked="" type="checkbox"/> No – go to 5 |
|                                     |    | <input type="checkbox"/> Yes – go to 4.1         |
- |                          |     |   |
|--------------------------|-----|---|
| <input type="checkbox"/> | 4.1 | Use all the seat controls that have any affect on the fore-aft movement of the seat to move the seat cushion to the rearmost position. <b>Mark</b> this position. (8/31/95 legal interpretation to Hogan and Hartson) |
|--------------------------|-----|---|
- |                          |     |  |
|--------------------------|-----|--|
| <input type="checkbox"/> | 4.2 | Use all the seat controls that have any affects on the fore-aft movement of the seat to move the seat cushion to the foremost position. <b>Mark</b> this position. (8/31/95 legal interpretation to Hogan and Hartson) |
|--------------------------|-----|--|
- |                          |     |   |
|--------------------------|-----|---|
| <input type="checkbox"/> | 4.3 | <b>Mark</b> each fore-aft position so that there is a visual indication when the seat is at a particular position. For manual seats, <b>mark</b> each detent. For power seats, mark only the rearmost, middle and foremost positions. Label three of the positions with the following: F for foremost, M for mid-position (if there is no mid-position, label the closest adjustment position to the rear of the mid-point), and R for rearmost. Determine the mid fore-aft seat position based on the foremost and rearmost positions determined in items 4.1 and 4.2. (8/31/95 legal interpretation to Hogan and Hartson) |
|--------------------------|-----|---|
- |                          |     |                                    |
|--------------------------|-----|------------------------------------|
| <input type="checkbox"/> | 4.4 | Move the seat to the mid position. |
|--------------------------|-----|------------------------------------|
- |                          |     |  |
|--------------------------|-----|--|
| <input type="checkbox"/> | 4.5 | While maintaining the mid position, move the seat to its lowest position. For seats with adjustable seat cushions, use the manufacturer's recommended seat cushion angle for determining the lowest height position. |
|--------------------------|-----|--|
- |                                     |    |   |
|-------------------------------------|----|---|
| <input checked="" type="checkbox"/> | 5. | Is the seat back angle adjustable?              |
|                                     |    | <input checked="" type="checkbox"/> No- go to 6 |
|                                     |    | <input type="checkbox"/> Yes- go to 5.1         |
- |                          |     |   |
|--------------------------|-----|---|
| <input type="checkbox"/> | 5.1 | Set and mark seat back angle, if adjustable, at the manufacturer's nominal design riding position for a 50 <sup>th</sup> percentile adult male in the manner specified by the manufacturer. |
|                          |     | <input type="checkbox"/> N/A – No seat back angle adjustment  |
|                          |     | <input type="checkbox"/> Manufacturer's design seat back angle: _____   |
|                          |     | <input type="checkbox"/> Tested seat back angle: _____  |

6. Is the seat a bucket seat?  
 Yes, go to 6.1 and skip 6.2  
 No, go to 6.2 and skip 6.1
- 6.1 Bucket seats:  
 Locate and mark the longitudinal centerline of the seat cushion. The intersection of the vertical longitudinal plane that passes through the SgRP and the seat cushion upper surface determines the longitudinal centerline of a bucket seat cushion. (S10.4.1.2 and S16.3.1.10)
- 6.2 Bench seats (complete ONLY the one that is applicable to the seat being tested):
- 6.2.1 Driver Seat  
 Locate and **mark** the longitudinal line on the seat cushion that marks the intersection of the vertical longitudinal plane through the centerline of the steering wheel and the seat cushion upper surface. (S10.4.1.1)
- 6.2.2 Front Outboard Passenger Seat  
 Locate and **mark** the longitudinal centerline of the passenger seat cushion. The longitudinal centerline is the same distance from the longitudinal centerline of the vehicle as the center of the steering wheel. (S10.4.1.1)  
 Record the distance from the longitudinal centerline of the vehicle to the center of the steering wheel. \_\_\_\_\_  
 Record the distance from the longitudinal centerline of the vehicle to the longitudinal centerline of the seat cushion. \_\_\_\_\_
- 6.2.3 Rear designated seating positions  
 Locate and **mark** the longitudinal centerline of the seat cushion. The intersection of the vertical longitudinal plane that passes through the SgRP and the seat cushion upper surface determines the longitudinal centerline.
7. Position the test dummies according to dummy position placement instructions in Appendix F. **Complete the Appendix F check sheets, but include them in the test report ONLY if there is a test failure.**
8. Fasten the seat belt latch.
9. Pull either 12 inches of belt webbing or the maximum available amount of belt webbing, whichever is less, from the retractor and then release it, allowing the belt webbing to return to the dummy's chest.
10. Locate the point where the centerline of the upper torso belt webbing crosses the midsagittal line on the dummy's chest. At that point pull the belt webbing out 3 inches from the dummy's chest and release until it is within one inch from the dummy's chest. (S10.8) Using a force measuring gage with a full scale range of no more than 1.5 pounds, measure the contact force perpendicular to the dummy's chest exerted by the belt webbing.  
 Contact Force (lb): **0.6**  
 0.0 to 0.7 pounds – Pass  
 **Greater than 0.7 pounds - FAIL**

REMARKS:

Signature: 

Date: 2/24/23

I certify that I have read and performed each instruction.

**DATA SHEET 11**  
**LATCH PLATE ACCESS (S7.4.4)**

Test Vehicle: 2023 Volvo XC40  
 Test Program: FMVSS 208 Compliance  
 Test Technician: Jose Galvez

NHTSA No.: C20235900  
 Test Date: 2/24/23

Test all front outboard seat belts **other than those in** walk-in van-type vehicles and those at front outboard designated seating positions in **passenger cars**. Complete a form for each applicable seat belt.

DESIGNATED SEATING POSITION:	Left Front Driver
------------------------------	-------------------

- |                                     |    |   |
|-------------------------------------|----|---|
| <input checked="" type="checkbox"/> | 1. | Position the seat's adjustable lumbar supports so that the lumbar support is in its lowest, retracted or deflated adjustment position. (S8.1.3) |
|                                     |    | <input type="checkbox"/> N/A – No lumbar adjustment   |
- |                                     |    |   |
|-------------------------------------|----|---|
| <input checked="" type="checkbox"/> | 2. | Position any adjustable parts of the seat that provide additional support so that they are in the lowest or most open adjustment position. (S16.2.10.2) |
|                                     |    | <input checked="" type="checkbox"/> N/A – No additional support adjustment  |
- |                                     |    |   |
|-------------------------------------|----|---|
| <input checked="" type="checkbox"/> | 3. | Is the fore-aft position of the seat adjustable?    |
|                                     |    | <input type="checkbox"/> No – go to 4               |
|                                     |    | <input checked="" type="checkbox"/> Yes – go to 3.1 |
- |                                     |     |   |
|-------------------------------------|-----|---|
| <input checked="" type="checkbox"/> | 3.1 | Use all the seat controls that have any affect on the fore-aft movement of the seat to move the seat cushion to the rearmost position. <b>Mark</b> this position. (8/31/95 legal interpretation to Hogan and Hartson) |
|-------------------------------------|-----|---|
- |                                     |     |   |
|-------------------------------------|-----|---|
| <input checked="" type="checkbox"/> | 3.2 | While maintaining the forward most position, move the seat to its lowest position. For seats with adjustable seat cushions, use the manufacturer's recommended seat cushion angle for determining the lowest height position. |
|-------------------------------------|-----|---|
- |                                     |    |  |
|-------------------------------------|----|--|
| <input checked="" type="checkbox"/> | 4. | Is the seat back angle adjustable?                 |
|                                     |    | <input type="checkbox"/> No- go to 5               |
|                                     |    | <input checked="" type="checkbox"/> Yes- go to 4.1 |
- |                                     |     |   |
|-------------------------------------|-----|---|
| <input checked="" type="checkbox"/> | 4.1 | Set and mark seat back angle, if adjustable, at the manufacturer's nominal design riding position for a <b>50<sup>th</sup> percentile adult male</b> in the manner specified by the manufacturer. |
|                                     |     | <input type="checkbox"/> N/A – No seat back angle adjustment  |
|                                     |     | <input checked="" type="checkbox"/> Manufacturer's design seat back angle: <u>20.0° on the Seat Back</u>  |
|                                     |     | <input checked="" type="checkbox"/> Tested seat back angle: <u>20.0° on the Seat Back</u>   |
- |                                     |    |   |
|-------------------------------------|----|---|
| <input checked="" type="checkbox"/> | 5. | Is the seat a bucket seat?                                      |
|                                     |    | <input checked="" type="checkbox"/> Yes, go to 5.1 and skip 5.2 |
|                                     |    | <input type="checkbox"/> No, go to 5.2 and skip 5.1             |
- |                                     |     |  |
|-------------------------------------|-----|--|
| <input checked="" type="checkbox"/> | 5.1 | Bucket seats:<br>Locate and <b>mark</b> the longitudinal centerline of the seat cushion. The intersection of the vertical longitudinal plane that passes through the SgRP and the seat cushion upper surface determines the longitudinal centerline of a bucket seat cushion. (S10.4.1.2 and S16.3.1.10) |
|-------------------------------------|-----|--|
- |                          |       |   |
|--------------------------|-------|---|
| <input type="checkbox"/> | 5.2   | Bench seats (complete ONLY the one that is applicable to the seat being tested):  |
| <input type="checkbox"/> | 5.2.1 | Driver Seat<br>Locate and <b>mark</b> the longitudinal line on the seat cushion that marks the intersection of the vertical longitudinal plane through the centerline of the steering wheel and the seat cushion upper surface. (S10.4.1.1) |

- 5.2.2 Front Outboard Passenger Seat  
 Locate and **mark** the longitudinal centerline of the passenger seat cushion.  
 The longitudinal centerline is the same distance from the longitudinal centerline of the vehicle as the center of the steering wheel. (S10.4.1.1)
- Record the distance from the longitudinal centerline of the vehicle to the center of the steering wheel. \_\_\_\_\_
- Record the distance from the longitudinal centerline of the vehicle to the longitudinal centerline of the seat cushion. \_\_\_\_\_
6. Position the test dummy using the procedures in Appendix F. (Some modifications to the positioning procedure may need to be made because the seat is in the forward most position. Note on the Appendix F positioning check sheet any deviations necessary to position the Part 572, Subpart E dummy). **Complete the Appendix F check sheets, but include them in the test report ONLY if there is a test failure.**
7. Position the adjustable seat belt anchorage in the manufacturer's nominal design position for a 50<sup>th</sup> percentile adult male occupant.
8. Attach the inboard reach string to the base of the head following the instructions on Figure 3.
9. Attach the outboard reach string to the torso sheath following the instructions on Figure 3.
10. Place the latch plate in the stowed position.
11. Extend the inboard reach string in front of the dummy and then backward and outboard to the latch plate to generate arcs of the reach envelope of the test dummy's arms. Is the latch plate within the reach envelope?
- Yes – Pass  
 No
12. Extend the outboard reach string in front of the dummy and then backward and outboard to the latch plate to generate arcs of the reach envelope of the test dummy's arms. Is the latch plate within the reach envelope?
- Yes – Pass  
 No
13. Is the latch plate within the inboard (item 11) or outboard (item 12) reach envelope?
- Yes – Pass  
 No – Fail
14. Using the clearance test block, specified in Figure 4, is there sufficient clearance between the vehicle seat and the side of vehicle interior to allow the test block to move unhindered to the latch plate or buckle?
- Yes – Pass  
 No – Fail

REMARKS:

Signature: 

Date: 2/24/23

I certify that I have read and performed each instruction.

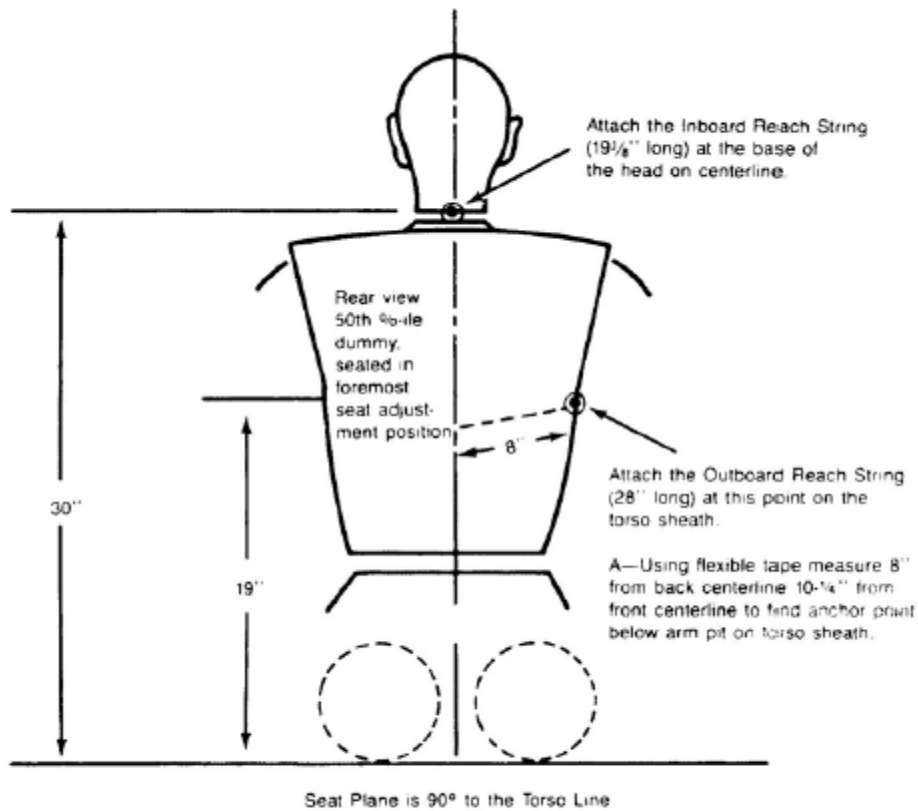

Figure 3. Location of Anchoring Points for Latchplate Reach Limiting Chains or Strings to Test for Latchplate Accessibility Using Subpart E Test Device

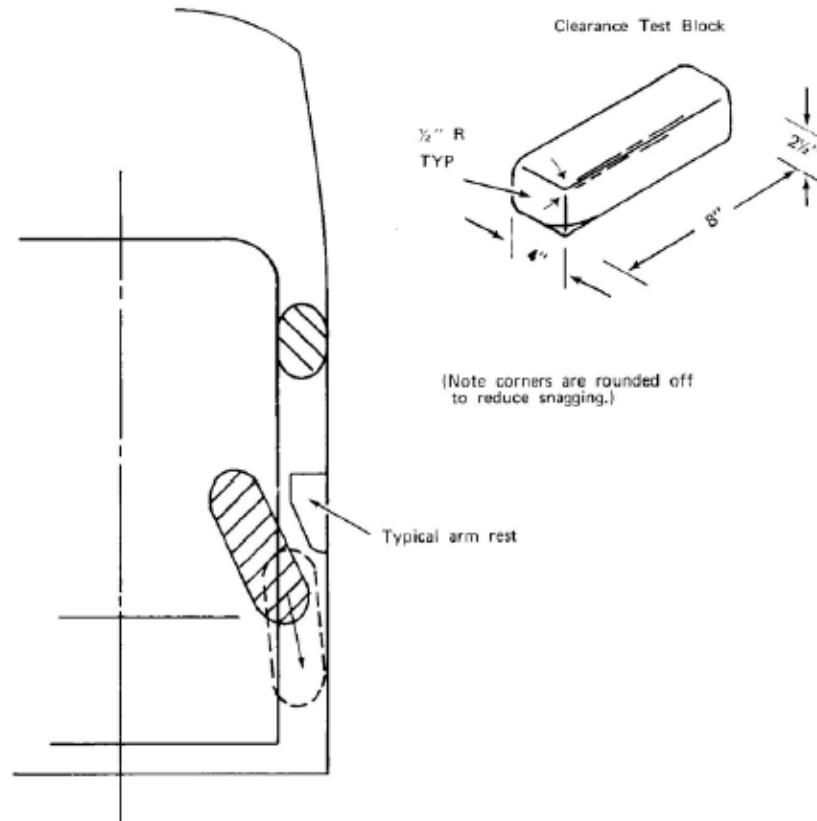

Figure 4—USE OF CLEARANCE TEST BLOCK TO DETERMINE HAND/ARM ACCESS

**DATA SHEET 11**  
**LATCH PLATE ACCESS (S7.4.4)**

Test Vehicle: 2023 Volvo XC40  
 Test Program: FMVSS 208 Compliance  
 Test Technician: Jose Galvez

NHTSA No.: C20235900  
 Test Date: 2/24/23

Test all front outboard seat belts **other than those in** walk-in van-type vehicles and those at front outboard designated seating positions in **passenger cars**. Complete a form for each applicable seat belt.

DESIGNATED SEATING POSITION:	Right Front Passenger
------------------------------	-----------------------

- |                                     |    |   |
|-------------------------------------|----|---|
| <input checked="" type="checkbox"/> | 1. | Position the seat's adjustable lumbar supports so that the lumbar support is in its lowest, retracted or deflated adjustment position. (S8.1.3) |
|                                     |    | <input type="checkbox"/> N/A – No lumbar adjustment   |
- |                                     |    |   |
|-------------------------------------|----|---|
| <input checked="" type="checkbox"/> | 2. | Position any adjustable parts of the seat that provide additional support so that they are in the lowest or most open adjustment position. (S16.2.10.2) |
|                                     |    | <input checked="" type="checkbox"/> N/A – No additional support adjustment  |
- |                                     |    |   |
|-------------------------------------|----|---|
| <input checked="" type="checkbox"/> | 3. | Is the fore-aft position of the seat adjustable?    |
|                                     |    | <input type="checkbox"/> No – go to 4               |
|                                     |    | <input checked="" type="checkbox"/> Yes – go to 3.1 |
- |                                     |     |   |
|-------------------------------------|-----|---|
| <input checked="" type="checkbox"/> | 3.1 | Use all the seat controls that have any effect on the fore-aft movement of the seat to move the seat cushion to the rearmost position. <b>Mark</b> this position. (8/31/95 legal interpretation to Hogan and Hartson) |
|-------------------------------------|-----|---|
- |                                     |     |   |
|-------------------------------------|-----|---|
| <input checked="" type="checkbox"/> | 3.2 | While maintaining the forward most position, move the seat to its lowest position. For seats with adjustable seat cushions, use the manufacturer's recommended seat cushion angle for determining the lowest height position. |
|-------------------------------------|-----|---|
- |                                     |    |  |
|-------------------------------------|----|--|
| <input checked="" type="checkbox"/> | 4. | Is the seat back angle adjustable?                 |
|                                     |    | <input type="checkbox"/> No- go to 5               |
|                                     |    | <input checked="" type="checkbox"/> Yes- go to 4.1 |
- |                                     |     |   |
|-------------------------------------|-----|---|
| <input checked="" type="checkbox"/> | 4.1 | Set and mark seat back angle, if adjustable, at the manufacturer's nominal design riding position for a <b>50<sup>th</sup> percentile adult male</b> in the manner specified by the manufacturer. |
|                                     |     | <input type="checkbox"/> N/A – No seat back angle adjustment  |
|                                     |     | <input checked="" type="checkbox"/> Manufacturer's design seat back angle: <u>20.0° on the Seat Back</u>  |
|                                     |     | <input checked="" type="checkbox"/> Tested seat back angle: <u>20.0° on the Seat Back</u>   |
- |                                     |    |   |
|-------------------------------------|----|---|
| <input checked="" type="checkbox"/> | 5. | Is the seat a bucket seat?                                      |
|                                     |    | <input checked="" type="checkbox"/> Yes, go to 5.1 and skip 5.2 |
|                                     |    | <input type="checkbox"/> No, go to 5.2 and skip 5.1             |
- |                                     |     |  |
|-------------------------------------|-----|--|
| <input checked="" type="checkbox"/> | 5.1 | Bucket seats:<br>Locate and <b>mark</b> the longitudinal centerline of the seat cushion. The intersection of the vertical longitudinal plane that passes through the SgRP and the seat cushion upper surface determines the longitudinal centerline of a bucket seat cushion. (S10.4.1.2 and S16.3.1.10) |
|-------------------------------------|-----|--|
- |                          |       |   |
|--------------------------|-------|---|
| <input type="checkbox"/> | 5.2   | Bench seats (complete ONLY the one that is applicable to the seat being tested):  |
| <input type="checkbox"/> | 5.2.1 | Driver Seat<br>Locate and <b>mark</b> the longitudinal line on the seat cushion that marks the intersection of the vertical longitudinal plane through the centerline of the steering wheel and the seat cushion upper surface. (S10.4.1.1) |

- 5.2.2 Front Outboard Passenger Seat  
 Locate and **mark** the longitudinal centerline of the passenger seat cushion.  
 The longitudinal centerline is the same distance from the longitudinal centerline of the vehicle as the center of the steering wheel. (S10.4.1.1)
- Record the distance from the longitudinal centerline of the vehicle to the center of the steering wheel. \_\_\_\_\_
- Record the distance from the longitudinal centerline of the vehicle to the longitudinal centerline of the seat cushion. \_\_\_\_\_
6. Position the test dummy using the procedures in Appendix F. (Some modifications to the positioning procedure may need to be made because the seat is in the forward most position. Note on the Appendix F positioning check sheet any deviations necessary to position the Part 572, Subpart E dummy). **Complete the Appendix F check sheets, but include them in the test report ONLY if there is a test failure.**
7. Position the adjustable seat belt anchorage in the manufacturer's nominal design position for a 50<sup>th</sup> percentile adult male occupant.
8. Attach the inboard reach string to the base of the head following the instructions on Figure 3.
9. Attach the outboard reach string to the torso sheath following the instructions on Figure 3.
10. Place the latch plate in the stowed position.
11. Extend the inboard reach string in front of the dummy and then backward and outboard to the latch plate to generate arcs of the reach envelope of the test dummy's arms. Is the latch plate within the reach envelope?
- Yes – Pass  
 No
12. Extend the outboard reach string in front of the dummy and then backward and outboard to the latch plate to generate arcs of the reach envelope of the test dummy's arms. Is the latch plate within the reach envelope?
- Yes – Pass  
 No
13. Is the latch plate within the inboard (item 11) or outboard (item 12) reach envelope?
- Yes – Pass  
 No – Fail
14. Using the clearance test block, specified in Figure 4, is there sufficient clearance between the vehicle seat and the side of vehicle interior to allow the test block to move unhindered to the latch plate or buckle?
- Yes – Pass  
 No – Fail

REMARKS:

Signature: 

Date: 2/24/23

I certify that I have read and performed each instruction.

**DATA SHEET 12**  
**SEAT BELT RETRACTION (S7.4.5)**

Test Vehicle: 2023 Volvo XC40  
 Test Program: FMVSS 208 Compliance  
 Test Technician: Jose Galvez

NHTSA No.: C20235900  
 Test Date: 2/24/23

Test all front outboard seat belts, except those in walk-in van-type vehicles and those at front outboard designated seating positions in passenger cars. Complete a form for each applicable seat belt.

DESIGNATED SEATING POSITION:	Left Front Driver
------------------------------	-------------------

- 1. Is the vehicle a passenger car or walk-in van-type vehicle?  
 Yes, this form is complete  
 No
- 2. Position the seat's adjustable lumbar supports so that the lumbar support is in its lowest, retracted or deflated adjustment position. (S8.1.3)  
 N/A – No lumbar adjustment
- 3. Position any adjustable parts of the seat that provide additional support so that they are in the lowest or most open adjustment position. (S16.2.10.2)  
 N/A – No additional support adjustment
- 4. Is the fore-aft position of the seat adjustable?  
 No – go to 5  
 Yes – go to 4.1
- 4.1 Use all the seat controls that have any affect on the fore-aft movement of the seat to move the seat cushion to the rearmost position. **Mark** this position. (8/31/95 legal interpretation to Hogan and Hartson)
- 4.2 Use all the seat controls that have any affects on the fore-aft movement of the seat to move the seat cushion to the foremost position. **Mark** this position. (8/31/95 legal interpretation to Hogan and Hartson)
- 4.3 **Mark** each fore-aft position so that there is a visual indication when the seat is at a particular position. For manual seats, **mark** each detent. For power seats, mark only the rearmost, middle and foremost positions. Label three of the positions with the following: F for foremost, M for mid-position (if there is no mid-position, label the closest adjustment position to the rear of the mid-point), and R for rearmost. Determine the mid fore-aft seat position based on the foremost and rearmost positions determined in items 4.1 and 4.2. (8/31/95 legal interpretation to Hogan and Hartson)
- 4.4 Move the seat to the mid position.
- 4.5 While maintaining the mid position, move the seat to its lowest position. For seats with adjustable seat cushions, use the manufacturer's recommended seat cushion angle for determining the lowest height position.
- 5. Is the seat back angle adjustable?  
 No- go to 6  
 Yes- go to 5.1
- 5.1 Set and mark seat back angle, if adjustable, at the manufacturer's nominal design riding position for a **50<sup>th</sup> percentile adult male** in the manner specified by the manufacturer.  
 N/A – No seat back angle adjustment  
 Manufacturer's design seat back angle: 20.0° on the Seat Back  
 Tested seat back angle: 20.0° on the Seat Back
- 6. Is the seat a bucket seat?  
 Yes, go to 6.1 and skip 6.2  
 No, go to 6.2 and skip 6.1

- 6.1 Bucket Seats:  
Locate and **mark** the longitudinal centerline of the seat cushion. The intersection of the vertical longitudinal plane that passes through the SgRP and the seat cushion upper surface determines the longitudinal centerline of a bucket seat cushion. (S10.4.1.2 and S16.3.1.10)
- 6.2 Bench seats (complete ONLY the one that is applicable to the seat being tested):
- 6.2.1 Driver Seat  
Locate and **mark** the longitudinal line on the seat cushion that marks the intersection of the vertical longitudinal plane through the centerline of the steering wheel and the seat cushion upper surface. (S10.4.1.1)
- 6.2.2 Front Outboard Passenger Seat  
Locate and **mark** the longitudinal centerline of the passenger seat cushion. The longitudinal centerline is the same distance from the longitudinal centerline of the vehicle as the center of the steering wheel. (S10.4.1.1)
- Record the distance from the longitudinal centerline of the vehicle to the center of the steering wheel. \_\_\_\_\_
- Record the distance from the longitudinal centerline of the vehicle to the longitudinal centerline of the seat cushion. \_\_\_\_\_
7. Position the Part 572 Subpart E test dummy according to dummy position placement instructions in Appendix F. **Complete the Appendix F check sheets, but include them in the test report ONLY if there is a test failure.**
8. Fasten the seat belt around the dummy.
9. Remove all slack from the lap belt portion. (S10.9)
- N/A, the seat does not have a fore-aft adjustment
10. Pull the upper torso webbing out of the retractor and allow it to retract; repeat this four times. (S10.9)
11. Apply a 2 to 4 pound tension load to the lap belt. (S10.9)  
**Pound load applied: 4**
12. Is the belt system equipped with a tension relieving device?
- Yes, continue
- No, go to 14
13. Introduce the maximum amount of slack into the upper torso belt that is recommended by the vehicle manufacturer in the vehicle owner's manual. (S10.9).
14. Check the statement that applies to this test vehicle:
- 14.1 The torso and lap belt webbing of the seat belt system automatically retracts to a stowed position when the adjacent vehicle door is in an open position and the seat belt latch plate is released.
- Yes – Pass go to 16
- No – go to 14.2
- 14.2 The torso and lap belt webbing of the seat belt system automatically retracts when the seat belt latch plate is released.
- Yes – Pass go to 15
- No – go to 14.3
- 14.3 Neither 14.1 nor 14.2 apply.
- Fail
15. With the webbing and hardware in the stowed position are the webbing and hardware prevented from being pinched when the door is closed?
- Yes – Pass
- No – Fail

16. If this test vehicle has an open body (without doors) and has a belt system with a tension relieving device, does the belt system fully retract when the tension-relieving device is deactivated?

N/A – Not an open body vehicle

Yes – Pass

No – Fail

REMARKS:

Signature: *Jose Galvez*

Date: 2/24/23

I certify that I have read and performed each instruction.

**DATA SHEET 12**  
**SEAT BELT RETRACTION (S7.4.5)**

Test Vehicle: 2023 Volvo XC40  
 Test Program: FMVSS 208 Compliance  
 Test Technician: Jose Galvez

NHTSA No.: C20235900  
 Test Date: 2/24/23

Test all front outboard seat belts, except those in walk-in van-type vehicles and those at front outboard designated seating positions in passenger cars. Complete a form for each applicable seat belt.

DESIGNATED SEATING POSITION:	Right Front Passenger
------------------------------	-----------------------

- |                                     |  |    |   |
|-------------------------------------|--|----|---|
| <input checked="" type="checkbox"/> |  | 1. | Is the vehicle a passenger car or walk-in van-type vehicle? |
|                                     |  |    | <input type="checkbox"/> Yes, this form is complete         |
|                                     |  |    | <input checked="" type="checkbox"/> No                      |
- |                                     |  |    |   |
|-------------------------------------|--|----|---|
| <input checked="" type="checkbox"/> |  | 2. | Position the seat's adjustable lumbar supports so that the lumbar support is in its lowest, retracted or deflated adjustment position. (S8.1.3) |
|                                     |  |    | <input type="checkbox"/> N/A – No lumbar adjustment   |
- |                                     |  |    |   |
|-------------------------------------|--|----|---|
| <input checked="" type="checkbox"/> |  | 3. | Position any adjustable parts of the seat that provide additional support so that they are in the lowest or most open adjustment position. (S16.2.10.2) |
|                                     |  |    | <input checked="" type="checkbox"/> N/A – No additional support adjustment  |
- |                                     |  |    |   |
|-------------------------------------|--|----|---|
| <input checked="" type="checkbox"/> |  | 4. | Is the fore-aft position of the seat adjustable?    |
|                                     |  |    | <input type="checkbox"/> No – go to 5               |
|                                     |  |    | <input checked="" type="checkbox"/> Yes – go to 4.1 |
- |                                     |  |     |   |
|-------------------------------------|--|-----|---|
| <input checked="" type="checkbox"/> |  | 4.1 | Use all the seat controls that have any effect on the fore-aft movement of the seat to move the seat cushion to the rearmost position. <b>Mark</b> this position. (8/31/95 legal interpretation to Hogan and Hartson) |
|-------------------------------------|--|-----|---|
- |                                     |  |     |  |
|-------------------------------------|--|-----|--|
| <input checked="" type="checkbox"/> |  | 4.2 | Use all the seat controls that have any effects on the fore-aft movement of the seat to move the seat cushion to the foremost position. <b>Mark</b> this position. (8/31/95 legal interpretation to Hogan and Hartson) |
|-------------------------------------|--|-----|--|
- |                                     |  |     |   |
|-------------------------------------|--|-----|---|
| <input checked="" type="checkbox"/> |  | 4.3 | <b>Mark</b> each fore-aft position so that there is a visual indication when the seat is at a particular position. For manual seats, <b>mark</b> each detent. For power seats, mark only the rearmost, middle and foremost positions. Label three of the positions with the following: F for foremost, M for mid-position (if there is no mid-position, label the closest adjustment position to the rear of the mid-point), and R for rearmost. Determine the mid fore-aft seat position based on the foremost and rearmost positions determined in items 4.1 and 4.2. (8/31/95 legal interpretation to Hogan and Hartson) |
|-------------------------------------|--|-----|---|
- |                                     |  |     |                                    |
|-------------------------------------|--|-----|------------------------------------|
| <input checked="" type="checkbox"/> |  | 4.4 | Move the seat to the mid position. |
|-------------------------------------|--|-----|------------------------------------|
- |                                     |  |     |  |
|-------------------------------------|--|-----|--|
| <input checked="" type="checkbox"/> |  | 4.5 | While maintaining the mid position, move the seat to its lowest position. For seats with adjustable seat cushions, use the manufacturer's recommended seat cushion angle for determining the lowest height position. |
|-------------------------------------|--|-----|--|
- |                                     |  |    |  |
|-------------------------------------|--|----|--|
| <input checked="" type="checkbox"/> |  | 5. | Is the seat back angle adjustable?                 |
|                                     |  |    | <input type="checkbox"/> No- go to 6               |
|                                     |  |    | <input checked="" type="checkbox"/> Yes- go to 5.1 |
- |                                     |  |     |   |
|-------------------------------------|--|-----|---|
| <input checked="" type="checkbox"/> |  | 5.1 | Set and mark seat back angle, if adjustable, at the manufacturer's nominal design riding position for a <b>50<sup>th</sup> percentile adult male</b> in the manner specified by the manufacturer. |
|                                     |  |     | <input type="checkbox"/> N/A – No seat back angle adjustment  |
|                                     |  |     | <input checked="" type="checkbox"/> Manufacturer's design seat back angle: <u>20.0° on the Seat Back</u>  |
|                                     |  |     | <input checked="" type="checkbox"/> Tested seat back angle: <u>20.0° on the Seat Back</u>   |
- |                                     |  |    |   |
|-------------------------------------|--|----|---|
| <input checked="" type="checkbox"/> |  | 6. | Is the seat a bucket seat?                                      |
|                                     |  |    | <input checked="" type="checkbox"/> Yes, go to 6.1 and skip 6.2 |
|                                     |  |    | <input type="checkbox"/> No, go to 6.2 and skip 6.1             |

- 6.1 Bucket Seats:  
Locate and **mark** the longitudinal centerline of the seat cushion. The intersection of the vertical longitudinal plane that passes through the SgRP and the seat cushion upper surface determines the longitudinal centerline of a bucket seat cushion. (S10.4.1.2 and S16.3.1.10)
- 6.2 Bench seats (complete ONLY the one that is applicable to the seat being tested):
- 6.2.1 Driver Seat  
Locate and **mark** the longitudinal line on the seat cushion that marks the intersection of the vertical longitudinal plane through the centerline of the steering wheel and the seat cushion upper surface. (S10.4.1.1)
- 6.2.2 Front Outboard Passenger Seat  
Locate and **mark** the longitudinal centerline of the passenger seat cushion. The longitudinal centerline is the same distance from the longitudinal centerline of the vehicle as the center of the steering wheel. (S10.4.1.1)
- Record the distance from the longitudinal centerline of the vehicle to the center of the steering wheel. \_\_\_\_\_
- Record the distance from the longitudinal centerline of the vehicle to the longitudinal centerline of the seat cushion. \_\_\_\_\_
7. Position the Part 572 Subpart E test dummy according to dummy position placement instructions in Appendix F. **Complete the Appendix F check sheets, but include them in the test report ONLY if there is a test failure.**
8. Fasten the seat belt around the dummy.
9. Remove all slack from the lap belt portion. (S10.9)
- N/A, the seat does not have a fore-aft adjustment
10. Pull the upper torso webbing out of the retractor and allow it to retract; repeat this four times. (S10.9)
11. Apply a 2 to 4 pound tension load to the lap belt. (S10.9)  
**Pound load applied: 3**
12. Is the belt system equipped with a tension relieving device?
- Yes, continue
- No, go to 14
13. Introduce the maximum amount of slack into the upper torso belt that is recommended by the vehicle manufacturer in the vehicle owner's manual. (S10.9).
14. Check the statement that applies to this test vehicle:
- 14.1 The torso and lap belt webbing of the seat belt system automatically retracts to a stowed position when the adjacent vehicle door is in an open position and the seat belt latch plate is released.
- Yes – Pass go to 16
- No – go to 14.2
- 14.2 The torso and lap belt webbing of the seat belt system automatically retracts when the seat belt latch plate is released.
- Yes – Pass go to 15
- No – go to 14.3
- 14.3 Neither 14.1 nor 14.2 apply.
- Fail
15. With the webbing and hardware in the stowed position are the webbing and hardware prevented from being pinched when the door is closed?
- Yes – Pass
- No – Fail

16. If this test vehicle has an open body (without doors) and has a belt system with a tension relieving device, does the belt system fully retract when the tension-relieving device is deactivated?

N/A – Not an open body vehicle

Yes – Pass

No – Fail

REMARKS:

Signature: \_\_\_\_\_



Date: 2/24/23

I certify that I have read and performed each instruction.

**DATA SHEET 13**

**SEAT BELT GUIDES AND HARDWARE (S7.4.6)**

Test Vehicle: 2023 Volvo XC40  
 Test Program: FMVSS 208 Compliance  
 Test Technician: Jose Galvez

NHTSA No.: C20235900  
 Test Date: 2/24/23

Test seat belts except those in walk-in van-type vehicles and those at front outboard designated seating positions in passenger cars. Complete a form for each applicable seat belt.

DESIGNATED SEATING POSITION: **Left Front Driver**

- |                                     |     |  |   |  |
|-------------------------------------|-----|--|---|--|
| <input checked="" type="checkbox"/> | 1.  | Is the seat cushion movable so that the seat back serves a function other than seating? (S7.4.6.1(b))  |   |  |
|                                     |     | <input type="checkbox"/> Yes, this form is complete  | <input checked="" type="checkbox"/> No, go to 2               |  |
| <input checked="" type="checkbox"/> | 2.  | Is the seat removable? (S7.4.6.1(b))   |   |  |
|                                     |     | <input type="checkbox"/> Yes, this form is complete  | <input checked="" type="checkbox"/> No, go to 3               |  |
| <input checked="" type="checkbox"/> | 3.  | Is the seat movable so that the space formerly occupied by the seat can be used for a secondary function? (S7.4.6.1(b))  |   |  |
|                                     |     | <input type="checkbox"/> Yes, this form is complete  | <input checked="" type="checkbox"/> No, go to 4               |  |
| <input checked="" type="checkbox"/> | 4.  | Is the webbing designed to pass through the seat cushion or between the seat cushion and seat back? (S7.4.6.1(a))  |   |  |
|                                     |     | <input type="checkbox"/> Yes, go to 5  | <input checked="" type="checkbox"/> No, this form is complete |  |
| <input type="checkbox"/>            | 5.  | Does one of the following three parts, the seat belt latch plate, the buckle, or the seat belt webbing, stay on top of or above the seat cushion under normal conditions (i.e., conditions other than when belt hardware is intentionally pushed behind the seat by a vehicle occupant)? (S7.4.6.1(a)) |   |  |
|                                     |     | <input type="checkbox"/> Yes – Pass  | <input type="checkbox"/> No – Fail                            |  |
|                                     |     | Identify the part(s) on top or above the seat.   |   |  |
|                                     |     | <input type="checkbox"/> Seat belt latch plate   | <input type="checkbox"/> Buckle                               | <input type="checkbox"/> Seat belt webbing |
| <input type="checkbox"/>            | 6.  | Are the remaining two seat belt parts accessible under normal conditions?  |   |  |
|                                     |     | <input type="checkbox"/> Yes – Pass  | <input type="checkbox"/> No – Fail                            |  |
| <input type="checkbox"/>            | 7.  | The buckle and latch plate do not pass through the guides or conduits provided and fall behind the seat when the belt is completely retracted or, if the belt is nonretractable, the belt is unlatched. (S7.4.6.2)   |   |  |
|                                     |     | <input type="checkbox"/> Yes – Pass  | <input type="checkbox"/> No – Fail                            |  |
| <input type="checkbox"/>            | 8.  | The buckle and latch plate do not pass through the guides or conduits provided and fall behind the seat when the seat is moved to any position to which it is designed to be adjusted. (S7.4.6.2)  |   |  |
|                                     |     | <input type="checkbox"/> Yes – Pass  | <input type="checkbox"/> No – Fail                            |  |
| <input type="checkbox"/>            | 9.  | The buckle and latch plate do not pass through the guides or conduits provided and fall behind the seat when the seat back, if foldable, is folded forward as far as possible and then moved backward into position. (S7.4.6.2)  |   |  |
|                                     |     | <input type="checkbox"/> Yes – Pass  | <input type="checkbox"/> No – Fail                            |  |
| <input type="checkbox"/>            | 10. | Is the inboard receptacle end of the seat belt assembly, installed in the front outboard designated seating position, accessible with the center armrest in any position to which it can be adjusted (without moving the armrest)? (S7.4.6.2)  |   |  |
|                                     |     | <input type="checkbox"/> Yes – Pass  | <input type="checkbox"/> No – Fail                            | <input type="checkbox"/> N/A – Rear seat   |

REMARKS:

Signature: 

Date: 2/24/23

I certify that I have read and performed each instruction.

DATA SHEET 13

SEAT BELT GUIDES AND HARDWARE (S7.4.6)

Test Vehicle: 2023 Volvo XC40
Test Program: FMVSS 208 Compliance
Test Technician: Jose Galvez

NHTSA No.: C20235900
Test Date: 2/24/23

Test seat belts except those in walk-in van-type vehicles and those at front outboard designated seating positions in passenger cars. Complete a form for each applicable seat belt.

DESIGNATED SEATING POSITION: Right Front Passenger

- 1. Is the seat cushion movable so that the seat back serves a function other than seating? (S7.4.6.1(b))
2. Is the seat removable? (S7.4.6.1(b))
3. Is the seat movable so that the space formerly occupied by the seat can be used for a secondary function? (S7.4.6.1(b))
4. Is the webbing designed to pass through the seat cushion or between the seat cushion and seat back? (S7.4.6.1(a))
5. Does one of the following three parts, the seat belt latch plate, the buckle, or the seat belt webbing, stay on top of or above the seat cushion under normal conditions...? (S7.4.6.1(a))
6. Are the remaining two seat belt parts accessible under normal conditions?
7. The buckle and latch plate do not pass through the guides or conduits provided and fall behind the seat when the belt is completely retracted or, if the belt is nonretractable, the belt is unlatched. (S7.4.6.2)
8. The buckle and latch plate do not pass through the guides or conduits provided and fall behind the seat when the seat is moved to any position to which it is designed to be adjusted. (S7.4.6.2)
9. The buckle and latch plate do not pass through the guides or conduits provided and fall behind the seat when the seat back, if foldable, is folded forward as far as possible and then moved backward into position. (S7.4.6.2)
10. Is the inboard receptacle end of the seat belt assembly, installed in the front outboard designated seating position, accessible with the center armrest in any position to which it can be adjusted (without moving the armrest)? (S7.4.6.2)

REMARKS:

Signature: Jose Galvez

Date: 2/24/23

I certify that I have read and performed each instruction.

**DATA SHEET 13**

**SEAT BELT GUIDES AND HARDWARE (S7.4.6)**

Test Vehicle: 2023 Volvo XC40  
 Test Program: FMVSS 208 Compliance  
 Test Technician: Jose Galvez

NHTSA No.: C20235900  
 Test Date: 2/24/23

Test seat belts except those in walk-in van-type vehicles and those at front outboard designated seating positions in passenger cars. Complete a form for each applicable seat belt.

DESIGNATED SEATING POSITION: **Left Rear Passenger**

- 1. Is the seat cushion movable so that the seat back serves a function other than seating? (S7.4.6.1(b))

Yes, this form is complete       No, go to 2

2. Is the seat removable? (S7.4.6.1(b))

Yes, this form is complete       No, go to 3

3. Is the seat movable so that the space formerly occupied by the seat can be used for a secondary function? (S7.4.6.1(b))

Yes, this form is complete       No, go to 4

4. Is the webbing designed to pass through the seat cushion or between the seat cushion and seat back? (S7.4.6.1(a))

Yes, go to 5       No, this form is complete

5. Does one of the following three parts, the seat belt latch plate, the buckle, or the seat belt webbing, stay on top of or above the seat cushion under normal conditions (i.e., conditions other than when belt hardware is intentionally pushed behind the seat by a vehicle occupant)? (S7.4.6.1(a))

Yes – Pass       No – Fail

Identify the part(s) on top or above the seat.

Seat belt latch plate       Buckle       Seat belt webbing

6. Are the remaining two seat belt parts accessible under normal conditions?

Yes – Pass       No – Fail

7. The buckle and latch plate do not pass through the guides or conduits provided and fall behind the seat when the belt is completely retracted or, if the belt is nonretractable, the belt is unlatched. (S7.4.6.2)

Yes – Pass       No – Fail

8. The buckle and latch plate do not pass through the guides or conduits provided and fall behind the seat when the seat is moved to any position to which it is designed to be adjusted. (S7.4.6.2)

Yes – Pass       No – Fail

9. The buckle and latch plate do not pass through the guides or conduits provided and fall behind the seat when the seat back, if foldable, is folded forward as far as possible and then moved backward into position. (S7.4.6.2)

Yes – Pass       No – Fail

10. Is the inboard receptacle end of the seat belt assembly, installed in the front outboard designated seating position, accessible with the center armrest in any position to which it can be adjusted (without moving the armrest)? (S7.4.6.2)

Yes – Pass       No – Fail       N/A – Rear seat

REMARKS:

Signature: 

Date: 2/24/23

I certify that I have read and performed each instruction.

**DATA SHEET 13**

**SEAT BELT GUIDES AND HARDWARE (S7.4.6)**

Test Vehicle: 2023 Volvo XC40  
 Test Program: FMVSS 208 Compliance  
 Test Technician: Jose Galvez

NHTSA No.: C20235900  
 Test Date: 2/24/23

Test seat belts except those in walk-in van-type vehicles and those at front outboard designated seating positions in passenger cars. Complete a form for each applicable seat belt.

DESIGNATED SEATING POSITION: **Center Rear Passenger**

- |                                     |  |     |  |  |   |
|-------------------------------------|--|-----|--|--|---|
| <input checked="" type="checkbox"/> |  | 1.  | Is the seat cushion movable so that the seat back serves a function other than seating? (S7.4.6.1(b))  | <input type="checkbox"/> Yes, this form is complete            | <input checked="" type="checkbox"/> No, go to 2                             |
| <input checked="" type="checkbox"/> |  | 2.  | Is the seat removable? (S7.4.6.1(b))   | <input type="checkbox"/> Yes, this form is complete            | <input checked="" type="checkbox"/> No, go to 3                             |
| <input checked="" type="checkbox"/> |  | 3.  | Is the seat movable so that the space formerly occupied by the seat can be used for a secondary function? (S7.4.6.1(b))  | <input checked="" type="checkbox"/> Yes, this form is complete | <input type="checkbox"/> No, go to 4  |
| <input type="checkbox"/>            |  | 4.  | Is the webbing designed to pass through the seat cushion or between the seat cushion and seat back? (S7.4.6.1(a))  | <input type="checkbox"/> Yes, go to 5                          | <input type="checkbox"/> No, this form is complete                          |
| <input type="checkbox"/>            |  | 5.  | Does one of the following three parts, the seat belt latch plate, the buckle, or the seat belt webbing, stay on top of or above the seat cushion under normal conditions (i.e., conditions other than when belt hardware is intentionally pushed behind the seat by a vehicle occupant)? (S7.4.6.1(a)) | <input type="checkbox"/> Yes – Pass                            | <input type="checkbox"/> No – Fail  |
|                                     |  |     | Identify the part(s) on top or above the seat.   | <input type="checkbox"/> Seat belt latch plate                 | <input type="checkbox"/> Buckle <input type="checkbox"/> Seat belt webbing  |
| <input type="checkbox"/>            |  | 6.  | Are the remaining two seat belt parts accessible under normal conditions?  | <input type="checkbox"/> Yes – Pass                            | <input type="checkbox"/> No – Fail  |
| <input type="checkbox"/>            |  | 7.  | The buckle and latch plate do not pass through the guides or conduits provided and fall behind the seat when the belt is completely retracted or, if the belt is nonretractable, the belt is unlatched. (S7.4.6.2)   | <input type="checkbox"/> Yes – Pass                            | <input type="checkbox"/> No – Fail  |
| <input type="checkbox"/>            |  | 8.  | The buckle and latch plate do not pass through the guides or conduits provided and fall behind the seat when the seat is moved to any position to which it is designed to be adjusted. (S7.4.6.2)  | <input type="checkbox"/> Yes – Pass                            | <input type="checkbox"/> No – Fail  |
| <input type="checkbox"/>            |  | 9.  | The buckle and latch plate do not pass through the guides or conduits provided and fall behind the seat when the seat back, if foldable, is folded forward as far as possible and then moved backward into position. (S7.4.6.2)  | <input type="checkbox"/> Yes – Pass                            | <input type="checkbox"/> No – Fail  |
| <input type="checkbox"/>            |  | 10. | Is the inboard receptacle end of the seat belt assembly, installed in the front outboard designated seating position, accessible with the center armrest in any position to which it can be adjusted (without moving the armrest)? (S7.4.6.2)  | <input type="checkbox"/> Yes – Pass                            | <input type="checkbox"/> No – Fail <input type="checkbox"/> N/A – Rear seat |

REMARKS:

Signature: *Jose Galvez*

Date: 2/24/23

I certify that I have read and performed each instruction.

DATA SHEET 13

SEAT BELT GUIDES AND HARDWARE (S7.4.6)

Test Vehicle: 2023 Volvo XC40
Test Program: FMVSS 208 Compliance
Test Technician: Jose Galvez

NHTSA No.: C20235900
Test Date: 2/24/23

Test seat belts except those in walk-in van-type vehicles and those at front outboard designated seating positions in passenger cars. Complete a form for each applicable seat belt.

DESIGNATED SEATING POSITION: Right Rear Passenger

- 1. Is the seat cushion movable so that the seat back serves a function other than seating? (S7.4.6.1(b))
2. Is the seat removable? (S7.4.6.1(b))
3. Is the seat movable so that the space formerly occupied by the seat can be used for a secondary function? (S7.4.6.1(b))
4. Is the webbing designed to pass through the seat cushion or between the seat cushion and seat back? (S7.4.6.1(a))
5. Does one of the following three parts, the seat belt latch plate, the buckle, or the seat belt webbing, stay on top of or above the seat cushion under normal conditions...? (S7.4.6.1(a))
6. Are the remaining two seat belt parts accessible under normal conditions?
7. The buckle and latch plate do not pass through the guides or conduits provided and fall behind the seat when the belt is completely retracted or, if the belt is nonretractable, the belt is unlatched. (S7.4.6.2)
8. The buckle and latch plate do not pass through the guides or conduits provided and fall behind the seat when the seat is moved to any position to which it is designed to be adjusted. (S7.4.6.2)
9. The buckle and latch plate do not pass through the guides or conduits provided and fall behind the seat when the seat back, if foldable, is folded forward as far as possible and then moved backward into position. (S7.4.6.2)
10. Is the inboard receptacle end of the seat belt assembly, installed in the front outboard designated seating position, accessible with the center armrest in any position to which it can be adjusted (without moving the armrest)? (S7.4.6.2)

REMARKS:

Signature: Jose Galvez

Date: 2/24/23

I certify that I have read and performed each instruction.

DATA SHEET 16

AIR BAG SUPPRESSION TELLTALE (S19.2.2)

Test Vehicle: 2023 Volvo XC40
Test Program: FMVSS 208 Compliance
Test Technician: Jose Galvez

NHTSA No.: C20235900
Test Date: 3/2/23

- X 1. Is the vehicle certified to any suppression performance standards of FMVSS 208?
X 2. Does telltale emit yellow light when the air bag is suppressed? (S19.2.2 (a))
X 3. Are the words "PASSENGER AIR BAG OFF" or "PASS AIR BAG OFF" (S19.2.2 (b))
X 3.1 on the telltale? (S19.2.2 (b))
3.2 Within 25 mm of the telltale? (S19.2.2 (b))
X 4. Is the telltale separate from the air bag readiness indicator? (S19.2.2(c))
X 5. Is the telltale within the interior of the vehicle? (S19.2.2 (d))
X 6. Is the telltale forward of and above the design H-point of both the driver's and the front outboard passenger's seat when the seats are in their forwardmost seating positions? (S19.2.2 (d))
X 7. Is the telltale away from surfaces that can be used for temporary or permanent storage of objects that could obscure the telltale from either the driver's or front outboard passenger's view? (S19.2.2 (d))
X 8. Is the telltale located so that it is not obscured from the driver or front outboard passenger by a rear-facing child restraint in Appendix A installed in the front outboard passenger seat? (S19.2.2 (d))
X 9. Is the telltale visible or recognizable during the night? (S19.2.2 (e))
X 10. Is the telltale visible or recognizable during the day? (S19.2.2 (e))
X 11. If there is a visibility adjustment, do all the adjustment levels make the telltale visible and recognizable? (S19.2.2 (g))
X 12. Does the telltale remain illuminated while the air bag is suppressed? (S19.2.2 (h))
X 13. Is the telltale off while the air bag is activated? (S19.2.2 (h))

Signature: Jose Galvez

Date: 2/24/23

I certify that I have read and performed each instruction.

## DATA SHEET 17 SUMMARY

Suppression Test Using 12-Month-Old CRABI Dummy (Part 572, Subpart R)  
Section B Rear Facing CRS

NHTSA NO.:	C20235900	TEST DATE:	3/2/23
LABORATORY:	MGA	TECHNICIAN:	JG
DUMMY TYPE:	12 Month Old	DUMMY SERIAL NO.:	062

CHILD RESTRAINT NAME:	Cosco
CHILD RESTRAINT MODEL:	Arriva 22-049 (same as model 22-013)
DATE OF MANUFACTURE:	8-20-2008

Base:  On  Off  N/A-Constraint does not have a removable base

Manufacturer's design seat back angle: 20.0° on the Seat Back  
 Tested seat back angle: 20.0° on the Seat Back  
 Manufacturer's specified anchorage position: 0 of 4; Upper-most defined as 0  
 Tested anchorage position: 0 of 4; Upper-most defined as 0

A blanket and visor were not used in the suppression testing because they did not affect the weight sensing system used on the vehicle.

### Test Summary

Seat Belt	Seat Slide	Cinch Load (N)	Result
Belted Rear Facing	Forward 110*	132	Suppressed
	Middle	132	Suppressed
	Rearward	130	Suppressed
Unbelted Rear Facing	Forward 120*	N/A	Suppressed
	Middle	N/A	Suppressed
	Rearward	N/A	Suppressed
Unbelted Forward Facing	Forward 50*	N/A	Suppressed
	Middle	N/A	Suppressed
	Rearward	N/A	Suppressed

\* The CRS would not fit in this Forward Slide position. If there is a number in the Seat Slide column, it indicates the fore-aft position with respect to the foremost position. (0 mm = Full Forward; 260 mm = Full Rearward; 260 mm total Seat Slide)

## DATA SHEET 17 SUMMARY

Suppression Test Using 12-Month-Old CRABI Dummy (Part 572, Subpart R)  
Section B Rear Facing CRS

NHTSA NO.:	C20235900	TEST DATE:	3/2/23
LABORATORY:	MGA	TECHNICIAN:	JG
DUMMY TYPE:	12 Month Old	DUMMY SERIAL NO.:	062

CHILD RESTRAINT NAME:	Cosco
CHILD RESTRAINT MODEL:	Arriva 22-049 (same as model 22-013)
DATE OF MANUFACTURE:	8-20-2008

Base: \_\_On X Off \_\_N/A-Constraint does not have a removable base

Manufacturer's design seat back angle: 20.0° on the Seat Back  
 Tested seat back angle: 20.0° on the Seat Back  
 Manufacturer's specified anchorage position: 0 of 4; Upper-most defined as 0  
 Tested anchorage position: 0 of 4; Upper-most defined as 0

A blanket and visor were not used in the suppression testing because they did not affect the weight sensing system used on the vehicle.

### Test Summary

Seat Belt	Seat Slide	Cinch Load (N)	Result
Belted Rear Facing	Forward 95*	128	Suppressed
	Middle	128	Suppressed
	Rearward	128	Suppressed
Unbelted Rear Facing	Forward 105*	N/A	Suppressed
	Middle	N/A	Suppressed
	Rearward	N/A	Suppressed
Unbelted Forward Facing	Forward	N/A	Suppressed
	Middle	N/A	Suppressed
	Rearward	N/A	Suppressed

\* The CRS would not fit in this Forward Slide position. If there is a number in the Seat Slide column, it indicates the fore-aft position with respect to the foremost position. (0 mm = Full Forward; 260 mm = Full Rearward; 260 mm total Seat Slide)

Successful Unbelted representative 5th percentile female reactivation was performed with the seat in the Rearward position. (Human Identification Code 036; 50.8 kg 149.9 cm)

## DATA SHEET 17 SUMMARY

Suppression Test Using 12-Month-Old CRABI Dummy (Part 572, Subpart R)  
Section B Rear Facing CRS

NHTSA NO.:	C20235900	TEST DATE:	3/2/23
LABORATORY:	MGA	TECHNICIAN:	JG
DUMMY TYPE:	12 Month Old	DUMMY SERIAL NO.:	062

CHILD RESTRAINT NAME:	Graco
CHILD RESTRAINT MODEL:	Snugride
DATE OF MANUFACTURE:	5-24-2007

Base:  On  Off  N/A-Constraint does not have a removable base

Manufacturer's design seat back angle: 20.0° on the Seat Back  
 Tested seat back angle: 20.0° on the Seat Back  
 Manufacturer's specified anchorage position: 0 of 4; Upper-most defined as 0  
 Tested anchorage position: 0 of 4; Upper-most defined as 0

A blanket and visor were not used in the suppression testing because they did not affect the weight sensing system used on the vehicle.

### Test Summary

Seat Belt	Seat Slide	Cinch Load (N)	Result
Belted Rear Facing	Forward 60*	132	Suppressed
	Middle	130	Suppressed
	Rearward	129	Suppressed
Unbelted Rear Facing	Forward 75*	N/A	Suppressed
	Middle	N/A	Suppressed
	Rearward	N/A	Suppressed
Unbelted Forward Facing	Forward 50*	N/A	Suppressed
	Middle	N/A	Suppressed
	Rearward	N/A	Suppressed

\* The CRS would not fit in this Forward Slide position. If there is a number in the Seat Slide column, it indicates the fore-aft position with respect to the foremost position. (0 mm = Full Forward; 260 mm = Full Rearward; 260 mm total Seat Slide)

## DATA SHEET 17 SUMMARY

### Suppression Test Using 12-Month-Old CRABI Dummy (Part 572, Subpart R) Section B Rear Facing CRS

NHTSA NO.:	C20235900	TEST DATE:	3/2/23
LABORATORY:	MGA	TECHNICIAN:	JG
DUMMY TYPE:	12 Month Old	DUMMY SERIAL NO.:	062

CHILD RESTRAINT NAME:	Graco
CHILD RESTRAINT MODEL:	Snugride
DATE OF MANUFACTURE:	5-24-2007

Base: \_\_On  Off \_\_N/A-Constraint does not have a removable base

Manufacturer's design seat back angle: 20.0° on the Seat Back  
 Tested seat back angle: 20.0° on the Seat Back  
 Manufacturer's specified anchorage position: 0 of 4; Upper-most defined as 0  
 Tested anchorage position: 0 of 4; Upper-most defined as 0

A blanket and visor were not used in the suppression testing because they did not affect the weight sensing system used on the vehicle.

#### Test Summary

Seat Belt	Seat Slide	Cinch Load (N)	Result
Belted Rear Facing	Forward 100*	129	Suppressed
	Middle	128	Suppressed
	Rearward	132	Suppressed
Unbelted Rear Facing	Forward 125*	N/A	Suppressed
	Middle	N/A	Suppressed
	Rearward	N/A	Suppressed
Unbelted Forward Facing	Forward	N/A	Suppressed
	Middle	N/A	Suppressed
	Rearward	N/A	Suppressed

\* The CRS would not fit in this Forward Slide position. If there is a number in the Seat Slide column, it indicates the fore-aft position with respect to the foremost position. (0 mm = Full Forward; 260 mm = Full Rearward; 260 mm total Seat Slide)

Successful Unbelted representative 5th percentile female reactivation was performed with the seat in the Middle position. (Human Identification Code 036; 50.8 kg 149.9 cm)

## DATA SHEET 17 SUMMARY

Suppression Test Using 12-Month-Old CRABI Dummy (Part 572, Subpart R)  
Section B Rear Facing CRS

NHTSA NO.:	C20235900	TEST DATE:	3/2/23
LABORATORY:	MGA	TECHNICIAN:	JG
DUMMY TYPE:	12 Month Old	DUMMY SERIAL NO.:	062

CHILD RESTRAINT NAME:	Peg Perego
CHILD RESTRAINT MODEL:	Primo Viaggio
DATE OF MANUFACTURE:	8-27-2007

Base:  On  Off  N/A-Constraint does not have a removable base

Manufacturer's design seat back angle: 20.0° on the Seat Back  
 Tested seat back angle: 20.0° on the Seat Back  
 Manufacturer's specified anchorage position: 0 of 4; Upper-most defined as 0  
 Tested anchorage position: 0 of 4; Upper-most defined as 0

A blanket and visor were not used in the suppression testing because they did not affect the weight sensing system used on the vehicle.

### Test Summary

Seat Belt	Seat Slide	Cinch Load (N)	Result
Belted Rear Facing	Forward 105*	133	Suppressed
	Middle	129	Suppressed
	Rearward	127	Suppressed
Unbelted Rear Facing	Forward 125*	N/A	Suppressed
	Middle	N/A	Suppressed
	Rearward	N/A	Suppressed
Unbelted Forward Facing	Forward	N/A	Suppressed
	Middle	N/A	Suppressed
	Rearward	N/A	Suppressed

\* The CRS would not fit in this Forward Slide position. If there is a number in the Seat Slide column, it indicates the fore-aft position with respect to the foremost position. (0 mm = Full Forward; 260 mm = Full Rearward; 260 mm total Seat Slide)

## DATA SHEET 17 SUMMARY

Suppression Test Using 12-Month-Old CRABI Dummy (Part 572, Subpart R)  
Section B Rear Facing CRS

NHTSA NO.:	C20235900	TEST DATE:	3/2/23
LABORATORY:	MGA	TECHNICIAN:	JG
DUMMY TYPE:	12 Month Old	DUMMY SERIAL NO.:	062

CHILD RESTRAINT NAME:	Peg Perego
CHILD RESTRAINT MODEL:	Primo Viaggio
DATE OF MANUFACTURE:	8-27-2007

Base:  On  Off  N/A-Constraint does not have a removable base

Manufacturer's design seat back angle: 20.0° on the Seat Back  
 Tested seat back angle: 20.0° on the Seat Back  
 Manufacturer's specified anchorage position: 0 of 4; Upper-most defined as 0  
 Tested anchorage position: 0 of 4; Upper-most defined as 0

A blanket and visor were not used in the suppression testing because they did not affect the weight sensing system used on the vehicle.

### Test Summary

Seat Belt	Seat Slide	Cinch Load (N)	Result
Belted Rear Facing	Forward 70*	128	Suppressed
	Middle	131	Suppressed
	Rearward	129	Suppressed
Unbelted Rear Facing	Forward 75*	N/A	Suppressed
	Middle	N/A	Suppressed
	Rearward	N/A	Suppressed
Unbelted Forward Facing	Forward	N/A	Suppressed
	Middle	N/A	Suppressed
	Rearward	N/A	Suppressed

\* The CRS would not fit in this Forward Slide position. If there is a number in the Seat Slide column, it indicates the fore-aft position with respect to the foremost position. (0 mm = Full Forward; 260 mm = Full Rearward; 260 mm total Seat Slide)

Successful Unbelted representative 5th percentile female reactivation was performed with the seat in the Forward position. (Human Identification Code 036; 50.8 kg 149.9 cm)

## DATA SHEET 17 SUMMARY

Suppression Test Using 12-Month-Old CRABI Dummy (Part 572, Subpart R)  
Section C Forward Facing Convertible CRS

NHTSA NO.:	C20235900	TEST DATE:	3/2/23
LABORATORY:	MGA	TECHNICIAN:	JG
DUMMY TYPE:	12 Month Old	DUMMY SERIAL NO.:	062

CHILD RESTRAINT NAME:	Britax
CHILD RESTRAINT MODEL:	Roundabout E9L02
DATE OF MANUFACTURE:	7-2-2008

Base:  On  Off  N/A-Constraint does not have a removable base

Manufacturer's design seat back angle: 20.0° on the Seat Back  
 Tested seat back angle: 20.0° on the Seat Back  
 Manufacturer's specified anchorage position: 0 of 4; Upper-most defined as 0  
 Tested anchorage position: 0 of 4; Upper-most defined as 0

A blanket was not used in the suppression testing because it did not affect the weight sensing system used on the vehicle.

### Test Summary

Seat Belt	Seat Slide	Cinch Load (N)	Result
Belted Forward Facing	Forward	131	Suppressed
	Middle	128	Suppressed
	Rearward	131	Suppressed
Unbelted Forward Facing	Forward	N/A	Suppressed
	Middle	N/A	Suppressed
	Rearward	N/A	Suppressed
Belted Rear Facing	Forward 65*	133	Suppressed
	Middle	130	Suppressed
	Rearward	130	Suppressed
Unbelted Rear Facing	Forward 100*	N/A	Suppressed
	Middle	N/A	Suppressed
	Rearward	N/A	Suppressed

\* The CRS would not fit in this Forward Slide position. If there is a number in the Seat Slide column, it indicates the fore-aft position with respect to the foremost position. (0 mm = Full Forward; 260 mm = Full Rearward; 260 mm total Seat Slide)

Successful Unbelted representative 5th percentile female reactivation was performed with the seat in the Forward position. (Human Identification Code 036; 50.8 kg 149.9 cm)

## DATA SHEET 17 SUMMARY

Suppression Test Using 12-Month-Old CRABI Dummy (Part 572, Subpart R)  
Section C Forward Facing Convertible CRS

NHTSA NO.:	C20235900	TEST DATE:	3/2/23
LABORATORY:	MGA	TECHNICIAN:	JG
DUMMY TYPE:	12 Month Old	DUMMY SERIAL NO.:	062

CHILD RESTRAINT NAME:	Cosco
CHILD RESTRAINT MODEL:	Summit Deluxe High Back Booster 22-262
DATE OF MANUFACTURE:	8-9-2007

Base:  On  Off  N/A-Constraint does not have a removable base

Manufacturer's design seat back angle: 20.0° on the Seat Back  
 Tested seat back angle: 20.0° on the Seat Back  
 Manufacturer's specified anchorage position: 0 of 4; Upper-most defined as 0  
 Tested anchorage position: 0 of 4; Upper-most defined as 0

A blanket was not used in the suppression testing because it did not affect the weight sensing system used on the vehicle.

### Test Summary

Seat Belt	Seat Slide	Cinch Load (N)	Result
Belted Forward Facing	Forward	127	Suppressed
	Middle	132	Suppressed
	Rearward	131	Suppressed
Unbelted Forward Facing	Forward	N/A	Suppressed
	Middle	N/A	Suppressed
	Rearward	N/A	Suppressed
Unbelted Rear Facing	Forward 100*	N/A	Suppressed
	Middle	N/A	Suppressed
	Rearward	N/A	Suppressed

\* The CRS would not fit in this Forward Slide position. If there is a number in the Seat Slide column, it indicates the fore-aft position with respect to the foremost position. (0 mm = Full Forward; 260 mm = Full Rearward; 260 mm total Seat Slide)

Successful Unbelted representative 5th percentile female reactivation was performed with the seat in the Middle position. (Human Identification Code 036; 50.8 kg 149.9 cm)

The Cosco Summit Deluxe High Back Booster 22-262 does not have a rear facing belt path.

## DATA SHEET 17 SUMMARY

Suppression Test Using 12-Month-Old CRABI Dummy (Part 572, Subpart R)  
Section C Forward Facing Convertible CRS

NHTSA NO.:	C20235900	TEST DATE:	3/2/23
LABORATORY:	MGA	TECHNICIAN:	JG
DUMMY TYPE:	12 Month Old	DUMMY SERIAL NO.:	062

CHILD RESTRAINT NAME:	Evenflo
CHILD RESTRAINT MODEL:	Tribute V 379
DATE OF MANUFACTURE:	6-20-2008

Base:  On  Off  N/A-Constraint does not have a removable base

Manufacturer's design seat back angle: 20.0° on the Seat Back  
 Tested seat back angle: 20.0° on the Seat Back  
 Manufacturer's specified anchorage position: 0 of 4; Upper-most defined as 0  
 Tested anchorage position: 0 of 4; Upper-most defined as 0

A blanket was not used in the suppression testing because it did not affect the weight sensing system used on the vehicle.

### Test Summary

Seat Belt	Seat Slide	Cinch Load (N)	Result
Belted Forward Facing	Forward	129	Suppressed
	Middle	132	Suppressed
	Rearward	132	Suppressed
Unbelted Forward Facing	Forward	N/A	Suppressed
	Middle	N/A	Suppressed
	Rearward	N/A	Suppressed
Belted Rear Facing	Forward 40*	128	Suppressed
	Middle	131	Suppressed
	Rearward	128	Suppressed
Unbelted Rear Facing	Forward 100*	N/A	Suppressed
	Middle	N/A	Suppressed
	Rearward	N/A	Suppressed

\* The CRS would not fit in this Forward Slide position. If there is a number in the Seat Slide column, it indicates the fore-aft position with respect to the foremost position. (0 mm = Full Forward; 260 mm = Full Rearward; 260 mm total Seat Slide)

Successful Unbelted representative 5th percentile female reactivation was performed with the seat in the Rearward position. (Human Identification Code 036; 50.8 kg 149.9 cm)

## DATA SHEET 17 SUMMARY

Suppression Test Using 12-Month-Old CRABI Dummy (Part 572, Subpart R)  
Section C Forward Facing Convertible CRS

NHTSA NO.:	C20235900	TEST DATE:	3/2/23
LABORATORY:	MGA	TECHNICIAN:	JG
DUMMY TYPE:	12 Month Old	DUMMY SERIAL NO.:	062

CHILD RESTRAINT NAME:	Graco
CHILD RESTRAINT MODEL:	Toddler SafeSeat Step 2
DATE OF MANUFACTURE:	5-24-2007

Base:  On  Off  N/A-Constraint does not have a removable base

Manufacturer's design seat back angle: 20.0° on the Seat Back  
 Tested seat back angle: 20.0° on the Seat Back  
 Manufacturer's specified anchorage position: 0 of 4; Upper-most defined as 0  
 Tested anchorage position: 0 of 4; Upper-most defined as 0

A blanket was not used in the suppression testing because it did not affect the weight sensing system used on the vehicle.

### Test Summary

Seat Belt	Seat Slide	Cinch Load (N)	Result
Belted Forward Facing	Forward	131	Suppressed
	Middle	127	Suppressed
	Rearward	128	Suppressed
Unbelted Forward Facing	Forward	N/A	Suppressed
	Middle	N/A	Suppressed
	Rearward	N/A	Suppressed
Unbelted Rear Facing	Forward 70*	N/A	Suppressed
	Middle	N/A	Suppressed
	Rearward	N/A	Suppressed

\* The CRS would not fit in this Forward Slide position. If there is a number in the Seat Slide column, it indicates the fore-aft position with respect to the foremost position. (0 mm = Full Forward; 260 mm = Full Rearward; 260 mm total Seat Slide)

Successful Unbelted representative 5th percentile female reactivation was performed with the seat in the Rearward position. (Human Identification Code 036; 50.8 kg 149.9 cm)

The Graco Toddler SafeSeat Step 2 does not have a rear facing belt path.

**DATA SHEET 18 SUMMARY**

Suppression Test Using Newborn Infant Dummy (Part 572, Subpart K)  
Section A Car Bed

NHTSA NO.:	C20235900	TEST DATE:	3/2/23
LABORATORY:	MGA	TECHNICIAN:	JG
DUMMY TYPE:	Newborn Infant	DUMMY SERIAL NO.:	003

CAR BED NAME:	Angel Guard
CAR BED MODEL:	Angel Ride
DATE OF MANUFACTURE:	4-15-2008

Base:  On  Off  N/A-Constraint does not have a removable base  
 (A car bed with a removable base shall be treated as two separate models, i.e. this form and test procedure will be completed with the base on and then repeated on a new form with the base off.

Manufacturer's design seat back angle: 20.0° on the Seat Back  
 Tested seat back angle: 20.0° on the Seat Back  
 Manufacturer's specified anchorage position: 0 of 4; Upper-most defined as 0  
 Tested anchorage position: 0 of 4; Upper-most defined as 0

A blanket and visor were not used in the suppression testing because they did not affect the weight sensing system used on the vehicle.

**Test Summary**

Seat Belt	Seat Slide	Result
Belted	Forward	Suppressed
	Middle	Suppressed
	Rearward	Suppressed

Successful Unbelted representative 5th percentile female reactivation was performed with the seat in the Forward position. (Human Identification Code 036; 50.8 kg 149.9 cm)

## DATA SHEET 25 SUMMARY

Low Risk Deployment Tests Using an Unbelted 3 Year Old Dummy  
(Part 572, Subpart P) (S22) Position 1 - Chest On Instrument Panel (S22.4.2)

NHTSA NO.:	C20235900	TEST DATE:	6/8/23
LABORATORY:	MGA	TECHNICIAN(S):	JG CR
DUMMY TYPE:	3 Year Old	DUMMY SERIAL NO.:	031

Manufacturer's design seat back angle:	<u>20.0° on the Seat Back</u>
Tested seat back angle:	<u>20.0° on the Seat Back</u>
Tested seat position:	<u>Full Aft</u>
Thorax cavity angle:	<u>0.0°</u>
Thigh angle:	<u>62.1°</u>
Point 1 height:	<u>0 mm – At Plane C Air Bag Height</u>

### Air Bag Deployment Timing

Stage No.	Firing time (ms)	Recorded firing time (ms)
1	0.0	0.0
2	190.0	190.0

### 3-Year-Old SN 031 Position 1 (Chest on Instrument Panel) 6/8/23

Injury Criteria	Max. Allowable Injury Assessment Values	Measured Value
HIC15	570	44
Peak Nij (Nte)	1.0	0.1
Time (ms)	NA	100.0
Peak Nij (Ntf)	1.0	0.3
Time (ms)	NA	12.1
Peak Nij (Nce)	1.0	0.0
Time (ms)	NA	35.5
Peak Nij (Ncf)	1.0	0.2
Time (ms)	NA	14.2
Neck Tension	1130 N	284
Neck Compression	1380 N	41
Chest g	55 g	11
Chest Displacement	34 mm	5

Calculated on data recorded for 100 ms after the initial deployment of the air bag. (S4.11(b))

**A service replacement air bag and instrument panel were used for this deployment.**

## DATA SHEET 26 SUMMARY

Low Risk Deployment Tests Using an Unbelted 3 Year Old Dummy  
(Part 572, Subpart P) (S22) Position 2 - Head On Instrument Panel (S22.4.3)

NHTSA NO.:	C20235900	TEST DATE:	6/9/23
LABORATORY:	MGA	TECHNICIAN(S):	JG CR
DUMMY TYPE:	3 Year Old	DUMMY SERIAL NO.:	031

Manufacturer's design seat back angle: 20.0° on the Seat Back  
 Tested seat back angle: 20.0° on the Seat Back  
 Tested seat position: Full Forward

Thorax cavity angle: 0.1°  
 Thigh angle: 9.1°

### Air Bag Deployment Timing

Stage No.	Firing time (ms)	Recorded firing time (ms)
1	0.0	0.0
2	190.0	190.0

### 3-Year-Old SN 031 Position 2 (Head on Instrument Panel) 6/9/23

Injury Criteria	Max. Allowable Injury Assessment Values	Measured Value
HIC15	570	5
Peak Nij (Nte)	1.0	0.0
Time (ms)	NA	11.9
Peak Nij (Ntf)	1.0	0.0
Time (ms)	NA	11.7
Peak Nij (Nce)	1.0	0.4
Time (ms)	NA	29.1
Peak Nij (Ncf)	1.0	0.3
Time (ms)	NA	40.2
Neck Tension	1130 N	45
Neck Compression	1380 N	687
Chest g	55 g	7
Chest Displacement	34 mm	0

Calculated on data recorded for 100 ms after the initial deployment of the air bag. (S4.11(b))

**A service replacement air bag and instrument panel were used for this deployment.**

## DATA SHEET 27 SUMMARY

Low Risk Deployment Tests Using an Unbelted 6-Year-Old Dummy (Part 572, Subpart N) (S24)  
Position 1 – Chest on Instrument Panel (S24.4.2)

NHTSA NO.:	C20235900	TEST DATE:	6/8/23
LABORATORY:	MGA	TECHNICIAN(S):	JG CR
DUMMY TYPE:	6 Year Old	DUMMY SERIAL NO.:	155

Manufacturer's design seat back angle: 20.0° on the Seat Back  
 Tested seat back angle: 20.0° on the Seat Back  
 Tested seat position: Full Aft

Thorax cavity angle: 5.9°  
 Point 1 height: 50 mm Below Plane C Air Bag Height

### Air Bag Deployment Timing

Stage No.	Firing time (ms)	Recorded firing time (ms)
1	0.0	0.0
2	190.0	190.0

### 6-Year-Old SN 155 Position 1 (Chest on Instrument Panel 6/8/23)

Injury Criteria	Max. Allowable Injury Assessment Values	Measured Value
HIC15	700	71
Peak Nij (Nte)	1.0	0.2
Time (ms)	NA	32.4
Peak Nij (Ntf)	1.0	0.2
Time (ms)	NA	12.6
Peak Nij (Nce)	1.0	0.0
Time (ms)	NA	0.0
Peak Nij (Ncf)	1.0	0.2
Time (ms)	NA	15.7
Neck Tension	1490 N	235
Neck Compression	1820 N	116
Chest g	60 g	6
Chest Displacement	40 mm	1

Calculated on data recorded for 100 ms after the initial deployment of the air bag. (S4.11(b))

**A service replacement air bag and instrument panel were used for this deployment.**

## DATA SHEET 28 SUMMARY

Low Risk Deployment Tests Using an Unbelted 6 Year Old Dummy  
(Part 572, Subpart N) (S24) Position 2 - Head On Instrument Panel (S24.4.3)

NHTSA NO.:	C20235900	TEST DATE:	6/7/23
LABORATORY:	MGA	TECHNICIAN(S):	JG CR
DUMMY TYPE:	6 Year Old	DUMMY SERIAL NO.:	155

Manufacturer's design seat back angle: 20.0° on the Seat Back  
 Tested seat back angle: 20.0° on the Seat Back  
 Tested seat position: Full Forward

Thorax cavity angle: 21.7°  
 Thigh angle: 7.3°

### Air Bag Deployment Timing

Stage No.	Firing time (ms)	Recorded firing time (ms)
1	0.0	0.0
2	190.0	190.0

### 6-Year-Old SN 155 Position 2 (Head on Instrument Panel) 6/7/23

Injury Criteria	Max. Allowable Injury Assessment Values	Measured Value
HIC15	700	5
Peak Nij (Nte)	1.0	0.4
Time (ms)	NA	72.2
Peak Nij (Ntf)	1.0	0.0
Time (ms)	NA	14.2
Peak Nij (Nce)	1.0	0.5
Time (ms)	NA	53.7
Peak Nij (Ncf)	1.0	0.1
Time (ms)	NA	10.1
Neck Tension	1490 N	151
Neck Compression	1820 N	454
Chest g	60 g	6
Chest Displacement	40 mm	0

Calculated on data recorded for 100 ms after the initial deployment of the air bag. (S4.11(b))

**The original equipment parts were used for this deployment.**

## DATA SHEET 29 SUMMARY

Low Risk Deployment Tests Using an Unbelted 5<sup>th</sup> Percentile Female  
Dummy (Part 572, Subpart O) (S26) Position 1 - Chin On Module (S26.2)

NHTSA NO.:	C20235900	TEST DATE:	6/7/23
LABORATORY:	MGA	TECHNICIAN:	JG CR
DUMMY TYPE:	5 <sup>th</sup> Percentile Female	DUMMY SERIAL NO.:	510

Manufacturer's design seat back angle: 20.0° on the Seat Back  
 Tested seat back angle: 20.0° on the Seat Back  
 Tested seat position: Full Aft

Tested steering wheel angle: 24.8°  
 Thorax cavity angle: 30.7°  
 Bottom of chin height: 0 mm – At Plane F Module Height

### Air Bag Deployment Timing

Stage No.	Firing time (ms)	Recorded firing time (ms)
1	0.0	0.0
2	175.0	175.0

### 5<sup>th</sup> Percentile Female SN 510 Position 1 (Chin On Module) 6/7/23

Injury Criteria	Max. Allowable Injury Assessment Values	Measured Value
HIC15	700	23
Peak Nij (Nte)	1.0	0.4
Time (ms)	NA	29.9
Peak Nij (Ntf)	1.0	0.3
Time (ms)	NA	5.6
Peak Nij (Nce)	1.0	0.0
Time (ms)	NA	210.8
Peak Nij (Ncf)	1.0	0.0
Time (ms)	NA	299.9
Neck Tension	2070 N	1020
Neck Compression	2520 N	23
Chest g	60 g	9
Chest Displacement	52 mm	7
Left Femur	6805 N	48
Right Femur	6805 N	63

Calculated on data recorded for 125 ms after the initiation of the final stage of air bag deployment designed to deploy in any full frontal rigid barrier crash up to 26 km/h. (S4.11 (d))  
 Second stage fire time of 175 ms; Injuries calculated on 0 ms to 300 ms.

**The original equipment parts were used for this deployment.**

### DATA SHEET 30 SUMMARY

Low Risk Deployment Tests Using an Unbelted 5<sup>th</sup> Percentile Female Dummy (Part 572, Subpart O) (S26) Position 2 - Chin On Rim (S26.3)

NHTSA NO.:	C20235900	TEST DATE:	6/7/23
LABORATORY:	MGA	TECHNICIAN:	JG CR
DUMMY TYPE:	5 <sup>th</sup> Percentile Female	DUMMY SERIAL NO.:	510

Manufacturer's design seat back angle: 20.0° on the Seat Back  
 Tested seat back angle: 20.0° on the Seat Back  
 Tested seat position: Full Aft

Tested steering wheel angle: 23.0° \*  
 Thorax cavity angle: 29.1°  
 Chin Point height: 2 mm Below Steering Wheel Target  
Note: The chin on rim steering wheel target is 10 mm below the highest point on the steering wheel

\*The dummy contacted the windshield with the steering wheel at mid position. The steering controls were adjusted to lower the upper steering wheel rim the necessary amount to bring the Chin Point coincident with the upper steering wheel rim. The rear thorax cavity was adjusted along with the steering wheel angle.

#### Air Bag Deployment Timing

Stage No.	Firing time (ms)	Recorded firing time (ms)
1	0.0	0.0
2	175.0	175.0

#### 5<sup>th</sup> Percentile Female SN 510 Position 2 (Chin On Rim) 6/7/23

Injury Criteria	Max. Allowable Injury Assessment Values	Measured Value
HIC15	700	28
Peak Nij (Nte)	1.0	0.5
Time (ms)	NA	14.9
Peak Nij (Ntf)	1.0	0.2
Time (ms)	NA	85.9
Peak Nij (Nce)	1.0	0.4
Time (ms)	NA	16.6
Peak Nij (Ncf)	1.0	0.2
Time (ms)	NA	93.3
Neck Tension	2070 N	764
Neck Compression	2520 N	93
Chest g	60 g	26
Chest Displacement	52 mm	31
Left Femur	6805 N	21
Right Femur	6805 N	35

Calculated on data recorded for 125 ms after the initiation of the final stage of air bag deployment designed to deploy in any full frontal rigid barrier crash up to 26 km/h. (S4.11 (d))  
 Second stage fire time of 175 ms; Injuries calculated on 0 ms to 300 ms.

**A service replacement air bag and steering column were used for this deployment.**

## DATA SHEET 32

### VEHICLE WEIGHT, FUEL TANK, AND ATTITUDE DATA

Test Vehicle: 2023 Volvo XC40  
 Test Program: FMVSS 208 Compliance  
 Test Technician: Chad Williams

NHTSA No.: C20235900  
 Test Date: 9/19/23

IMPACT ANGLE:	0°			
BELTED DUMMIES (YES/NO):	YES			
TEST SPEED:	32 to 56 kmph	0 to 48 kmph	X	0 to 56 kmph
DRIVER DUMMY:	X	5 <sup>th</sup> female		50 <sup>th</sup> male
PASSENGER DUMMY:	X	5 <sup>th</sup> female		50 <sup>th</sup> male

- 1. Fill the transmission with transmission fluid to the satisfactory range.
- 2. Drain fuel from vehicle.
- 3. Run the engine until fuel remaining in the fuel delivery system is used and the engine stops.
- 4. Record the useable fuel tank capacity supplied by the COTR.
- Useable Fuel Tank Capacity supplied by COTR: 53.7 liters (14.2 gallons)
- 5. Record the fuel tank capacity supplied in the owner's manual.
- Useable Fuel Tank Capacity in owner's manual: 53.7 liters (14.2 gallons)
- 6. Using purple dyed Stoddard solvent having the physical and chemical properties of Type 1 solvent or cleaning fluid, Table 1, ASTM Standard D484-71, "Standard Specifications for Hydrocarbon Dry-cleaning Solvents," or gasoline, fill the fuel tank. Amount Added: 53.7 liters (14.2 gallons)
- 7. Fill the coolant system to capacity.
- 8. Fill the engine with motor oil to the Max. mark on the dip stick.
- 9. Fill the brake reservoir with brake fluid to its normal level.
- 10. Fill the windshield washer reservoir to capacity.
- 11. Inflate the tires to the tire pressure on the tire placard. If no tire placard is available, inflate the tires to the recommended pressure in the owner's manual.

Tire placard pressure:	RF: 33 psi	LF: 33 psi	RR: 33 psi	LR: 33 psi
Owner's manual pressure:	RF: 33 psi	LF: 33 psi	RR: 33 psi	LR: 33 psi
Actual inflated pressure:	RF: 33 psi	LF: 33 psi	RR: 33 psi	LR: 33 psi

- 12. Record the vehicle weight at each wheel to determine the unloaded vehicle weight (UVW), i.e. "as delivered" weight).

Right Front (kg):	497.6	Right Rear (kg):	337.9
Left Front (kg):	500.8	Left Rear (kg):	348.4
Total Front (kg):	998.4	Total Rear (kg):	686.3
% Total Weight:	59.3	% Total Weight:	40.7
UVW = TOTAL FRONT PLUS TOTAL REAR (KG):		1684.7	

- 13. UVW Test Vehicle Attitude: (All dimensions in millimeters)
- 13.1 Mark a point on the vehicle above the center of each wheel.
- 13.2 Place the vehicle on a level surface.
- 13.3 Measure perpendicular to the level surface to the 4 points marked on the body and record the measurements.

RF:	774	LF:	779	RR:	797	LR:	798
-----	-----	-----	-----	-----	-----	-----	-----

14. Calculate the Rated Cargo and Luggage Weight (RCLW): 80 kg
- 14.1 Does the vehicle have the vehicle capacity weight (VCW) on the certification label or tire placard?
- Yes, go to 14.3
- No, go to 14.2
- 14.2 VCW = Gross Vehicle Weight - UVW
- VCW = \_\_\_\_\_ - \_\_\_\_\_ = \_\_\_\_\_

- 14.3 VCW = 420 kg (925 lbs)
- 14.4 Does the certification or tire placard contain the Designated Seating Capacity (DSC)?
- Yes, go to 14.6
- No, go to 14.5 and skip 14.6
- 14.5 DSC = Total number of seat belt assemblies = \_\_\_\_\_
- 14.6 DSC = 5
- 14.7 RCLW = VCW - (68 kg x DSC) = 420 kg - (68 kg x 5) = 80 kg
- 14.8 Is the vehicle certified as a truck, MPV or bus (see the certification label on the door jamb)?
- Yes, if the calculated RCLW is greater than 136 kg, use 136 kg as the RCLW. (S8.1.1)
- No, use the RCLW calculated in 14.7

15. Fully Loaded Weight (100% fuel fill): 1865.7 kg
- 15.1 Place the appropriate test dummy in both front outboard seating positions.

Driver:         5<sup>th</sup> female    \_\_\_ 50<sup>th</sup> male  
 Passenger:    5<sup>th</sup> female    \_\_\_ 50<sup>th</sup> male

- 15.2 Load the vehicle with the RCLW from 14.7 or 14.8 whichever is applicable.
- 15.3 Place the RCLW in the cargo area. Center the load over the longitudinal centerline of the vehicle. (S8.1.1 (d))
- 15.4 Record the vehicle weight at each wheel to determine the Fully Loaded Weight.

Right Front (kg):	517.6	Right Rear (kg):	411.9
Left Front (kg):	517.1	Left Rear (kg):	419.3
Total Front (kg):	1034.7	Total Rear (kg):	831.0
% Total Weight:	55.5	% Total Weight:	44.5
% GVW	53.3	% GVW	48.8
(% GVW = Axle GVW divided by Vehicle GVW)			
Fully Loaded Weight = Total Front Plus Total Rear (kg):			1865.7

16. Fully Loaded Test Vehicle Attitude: (All dimensions in millimeters)
- 16.1 Place the vehicle on a level surface.
- 16.2 Measure perpendicular to the level surface to the 4 points marked on the body (see 13.1 above) and record the measurements.

RF:	770	LF:	773	RR:	776	LR:	777
-----	-----	-----	-----	-----	-----	-----	-----

17. Drain the fuel system.

18. Using purple dyed Stoddard solvent having the physical and chemical properties of Type 1 solvent or cleaning fluid, Table 1, ASTM Standard D484-71, "Standard Specifications for Hydrocarbon Dry-cleaning Solvents," fill the fuel tank to 92 - 94 percent of useable capacity.

Fuel tank capacity x .94 = 53.7 liters (14.2 gallons) x .94 = 50.5 liters (13.3 gallons)

Amount added: 50.0 liters (13.2 gallons) 93.0%

19. Crank the engine to fill the fuel delivery system with Stoddard solvent.

20. Calculate the test weight range.

20.1 Calculated Weight = UVW (see 12 above) + RCLW (see 14 above) + 2x(dummy weight)

$$\underline{1862.7 \text{ kg}} = \underline{1684.7 \text{ kg}} + \underline{80.0 \text{ kg}} + \underline{98.0 \text{ kg}}$$

20.2 Test Weight Range = Calculated Weight (- 4.5 kg, - 9 kg.)

$$\text{Max. Test Weight} = \text{Calculated Test Weight} - 4.5 \text{ kg} = \underline{1858.2 \text{ kg}}$$

$$\text{Min. Test Weight} = \text{Calculated Test Weight} - 9 \text{ kg} = \underline{1853.7 \text{ kg}}$$

21. Remove the RCLW from the cargo area.

22. Drain transmission fluid, engine coolant, motor oil, and windshield washer fluid from the test vehicle so that Stoddard solvent leakage from the fuel system will be evident.

23. Vehicle Components Removed For Weight Reduction:

Spare Tire and Cover, Front Underbody Cover, Cargo Carpet

24. Secure the equipment and ballast in the load carrying area and distribute it, as nearly as possible, to obtain the proportion of axle weight indicated by the gross axle weight ratings and center it over the longitudinal centerline of the vehicle.

25. If necessary, add ballast to achieve the actual test weight.

N/A

Weight of Ballast: 64.4 kg

26. Ballast, including test equipment, must be contained so that it will not shift during the impact event or interfere with data collection or interfere with high-speed film recordings or affect the structural integrity of the vehicle or do anything else to affect test results. Care must be taken to assure that any attachment hardware added to the vehicle is not in the vicinity of the fuel tank or lines.

27. Record the vehicle weight at each wheel to determine the actual test weight.

Right Front (kg):	520.7	Right Rear (kg):	400.5
Left Front (kg):	520.8	Left Rear (kg):	413.7
Total Front (kg):	1041.5	Total Rear (kg):	814.2
% Total Weight:	56.1	% Total Weight:	43.9
% GVW	53.3	% GVW	48.8
(% GVW = Axle GVW divided by Vehicle GVW)			
TOTAL FRONT PLUS TOTAL REAR (kg):			1855.7

28. Is the test weight between the Max. Weight and the Min. Weight (See 20.2)?

Yes

No, explain why not.

29. Test Weight Vehicle Attitude: (all dimensions in millimeters)

29.1 Place the vehicle on a level surface.

29.2 Measure perpendicular to the level surface to the 4 points marked on the body (see 13 above) and record the measurements.

RF:	774	LF:	779	RR:	783	LR:	784
-----	-----	-----	-----	-----	-----	-----	-----

- 30. Summary of test attitude
- 30.1 AS DELIVERED:

RF:	774	LF:	779	RR:	797	LR:	798
-----	-----	-----	-----	-----	-----	-----	-----

AS TESTED:

RF:	774	LF:	779	RR:	783	LR:	784
-----	-----	-----	-----	-----	-----	-----	-----

FULLY LOADED:

RF:	770	LF:	773	RR:	776	LR:	777
-----	-----	-----	-----	-----	-----	-----	-----

- 30.2 Is the “as tested” test attitude equal to or between the “fully loaded” and “as delivered” attitude?

- Yes
- No, explain why not.

REMARKS:

Signature: Chad Wilkin Date: 9/19/23

I certify that I have read and performed each instruction.

**DATA SHEET 33**

**VEHICLE ACCELEROMETER LOCATION AND MEASUREMENT**

Test Vehicle: 2023 Volvo XC40  
 Test Program: FMVSS 208 Compliance  
 Test Technician: Chad Williams

NHTSA No.: C20235900  
 Test Date: 9/19/23

IMPACT ANGLE:	0°			
BELTED DUMMIES (YES/NO):	YES			
TEST SPEED:	32 to 56 kmph	0 to 48 kmph	X	0 to 56 kmph
DRIVER DUMMY:	X	5 <sup>th</sup> female		50 <sup>th</sup> male
PASSENGER DUMMY:	X	5 <sup>th</sup> female		50 <sup>th</sup> male

- 1. Find the location where the vertical plane parallel to the longitudinal centerline of the vehicle and through the center of the left front outboard seating position intersects the left rear seat cross member. Install an accelerometer at this intersection on the rear seat cross member to record x-direction accelerations. Record the location on the following chart.
- 2. Find the location where the vertical plane parallel to the longitudinal centerline of the vehicle and through the center of the right front outboard seating position intersects the right rear seat cross member. Install an accelerometer at this intersection on the rear seat cross member to record x-direction accelerations. Record the location on the following chart.
- 3. Find the location where a vertical plane through the longitudinal centerline of the vehicle and a vertical transverse plane through the center of the two wheels on opposite sides of the engine intersect at the top of the engine. Install an accelerometer at this intersection to record x-direction accelerations. Record the location on the following chart.
- 4. Find the location where a vertical plane through the longitudinal centerline of the vehicle and a vertical transverse plane through the center of the two wheels on opposite sides of the engine intersect the bottom of the engine. Install an accelerometer at this intersection to record x-direction accelerations. Record the location on the following chart.
- 5. Install an accelerometer on the right front brake caliper to record x-direction accelerations. Record the location on the following chart.
- 6. Find the location where a vertical plane through the longitudinal centerline of the vehicle intersects the top of the instrument panel. Install an accelerometer at this intersection to record x-direction accelerations. Record the location on the following chart.
- 7. Install an accelerometer on the left front brake caliper to record x-direction accelerations. Record the location on the following chart.
- 8. Find the location where a vertical plane through the longitudinal centerline of the vehicle intersects the floor of the trunk. Install an accelerometer on the trunk floor at this intersection to record z-direction accelerations. Record the location on the following chart.

REMARKS:

I certify that I have read and performed each instruction.

Signature: Chad Williams

Date: 9/19/23

# VEHICLE ACCELEROMETER LOCATION AND DATA SUMMARY

CENTERLINE OF FRONT WHEELS

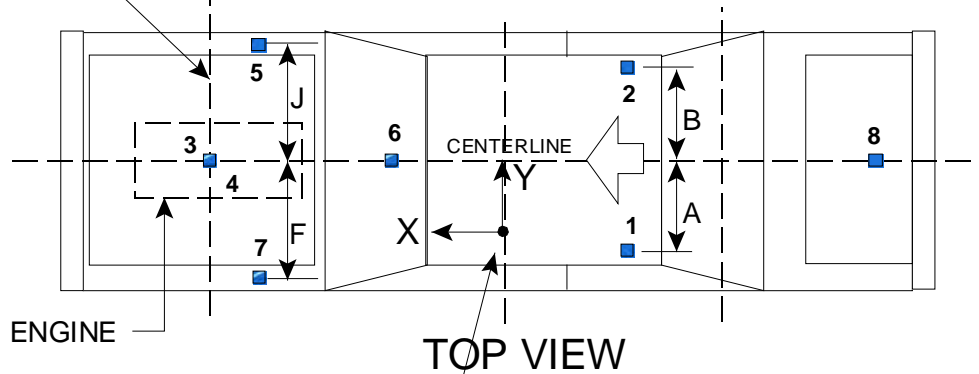

ACCELEROMETER COORDINATE SYSTEM (POSITIVE DIRECTION SHOWN)

REAR SEAT CUSHION ASSY. FRONT ATTACHMENT BRACKET SUPPORT

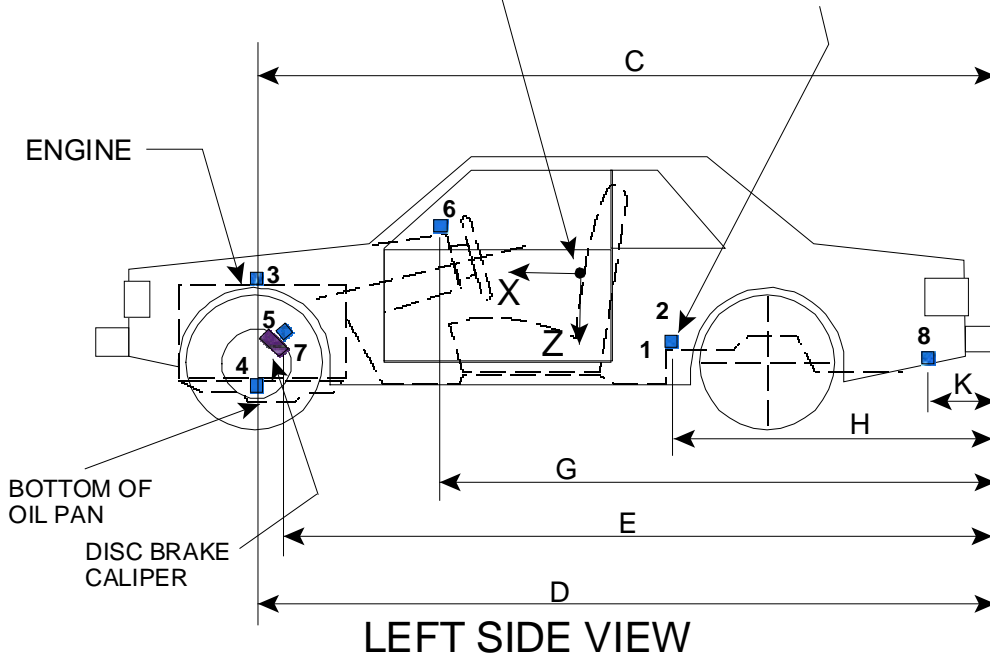

Dimensions Corresponding To The Letters "A" Through "K" (Excluding "I") Are Recorded In The Table On The Following Page.

Accelerometers Corresponding To The Numbers 1 Through 8 Are Specified On The Preceding Page.

**VEHICLE ACCELEROMETER LOCATION AND MEASUREMENTS**

<u>DIMENSION</u>	<u>LENGTH (mm)</u>	
<b><u>PRETEST VALUES</u></b>		
<u>A</u> (LH Rear Seat Xmbr)	370	
<u>B</u> (RH Rear Seat Xmbr)	359	
<u>C</u> (Engine Top)	3751	
<u>D</u> (Engine Bottom)	3712	
<u>E</u> (Caliper)	Right Side: 3761	Left Side: 3760
<u>F</u> (Left Caliper)	680	
<u>G</u> (IP)	2843	
<u>H</u> (Seat)	1687	
<u>J</u> (Right Caliper)	680	
<u>K</u> (Trunk)	966	
<b><u>POST TEST VALUES</u></b>		
<u>A</u> (LH Rear Seat Xmbr)	370	
<u>B</u> (RH Rear Seat Xmbr)	359	
<u>C</u> (Engine Top)	3567	
<u>D</u> (Engine Bottom)	3588	
<u>E</u> (Caliper)	Right Side: 3721	Left Side: 3738
<u>F</u> (Left Caliper)	671	
<u>G</u> (IP)	2840	
<u>H</u> (Seat)	1687	
<u>J</u> (Right Caliper)	676	
<u>K</u> (Trunk)	966	

**DATA SHEET 34**  
**PHOTOGRAPHIC TARGETS**

Test Vehicle: 2023 Volvo XC40  
 Test Program: FMVSS 208 Compliance  
 Test Technician: Chad Williams

NHTSA No.: C20235900  
 Test Date: 9/19/23

IMPACT ANGLE:	0°			
BELTED DUMMIES (YES/NO):	YES			
TEST SPEED:	<input type="checkbox"/> 32 to 56 kmph	<input type="checkbox"/> 0 to 48 kmph	<input checked="" type="checkbox"/> 0 to 56 kmph	
DRIVER DUMMY:	<input checked="" type="checkbox"/> X	5 <sup>th</sup> female		50 <sup>th</sup> male
PASSENGER DUMMY:	<input checked="" type="checkbox"/> X	5 <sup>th</sup> female		50 <sup>th</sup> male

- 1. **FMVSS 208 vehicle targeting requirements** (See Figures 28A and 28B)
- 1.1 Targets A1 and A2 are on flat rectangular panels.
- 1.2 Three circular targets at least 90 mm in diameter and with black and yellow quadrants are mounted at the front on the outboard sides of A1 and A2. The center of each circular target is 100 mm from the one next to it.
- 1.3 Distance between targets (mm): 100 mm
- 1.4 Three circular targets at least 90 mm in diameter and with black and yellow quadrants are mounted at the back on the outboard sides of on A1 and A2. The center of each circular target is 100 mm from the one next to it.
- 1.5 Distance between targets (mm): 100 mm
- 1.6 The distance between the first circular target at the front of A1 and A2 and the last circular target at the back of A1 and A2 is at least 915 mm.
- 1.7 Distance between the first and last circular targets (mm): 915 mm
- 1.8 Firmly fix target A1 on the vehicle roof in the vertical longitudinal plane that is coincident with the midsagittal plane of the driver dummy.
- 1.9 Firmly fix target A2 on the vehicle roof in the vertical longitudinal plane that is coincident with the midsagittal plane of the passenger dummy.
- 1.10 Two circular targets (C1 and C2) at least 90 mm in diameter and with black and yellow quadrants are mounted on the outside of the driver door. The centers of each circular target are at least 610 mm apart.
- 1.11 Distance between targets (mm): 610 mm
- 1.12 Two circular targets (C1 and C2) at least 90 mm in diameter and with black and yellow quadrants are mounted on the outside of the passenger door. The centers of each circular target are at least 610 mm apart.
- 1.13 Distance between targets (mm): 612 mm
- 1.14 Place tape with squares having alternating colors on the top portion of the steering wheel.
- 1.15 Chalk the bottom portion of the steering wheel.
- 1.16 Is this an offset test?
- Yes, continue with this section**
- No, go to 2.**
- 1.17 Measure the width of the vehicle.
- Vehicle width (mm):
- 1.18 Find the centerline of the vehicle. ( $\frac{1}{2}$  of the vehicle width)
- 1.19 Find the line parallel to the centerline of the vehicle and 0.1 x vehicle width from the centerline of the vehicle.
- 1.20 Apply 25 mm wide tape with alternating black and yellow squares parallel to and on each side of the line found in 1.19. The edge of each tape shall be 50 mm from the line found in 1.19. The tape shall extend from the bottom of the bumper to the front edge of the windshield. (Figure 28D)

2. **Barrier Targeting**
- 2.1 Fix two stationary targets D1 and D2 to the barrier as shown in the Figure 28A. One target is in the vertical longitudinal plane that is coincident with the midsagittal plane of the driver dummy. The other is in the vertical longitudinal plane that is coincident with the midsagittal plane of the passenger dummy.
- 2.2 Targets D1 and D2 are on a rectangular panel.
- 2.3 Three circular targets at least 90 mm in diameter and with black and yellow quadrants are mounted on the sides of the rectangular panel away from the longitudinal centerline of the vehicle. The center of each circular target is 100 mm from the one next to it.
- Distance between circular targets on D1 (mm): 100 mm
- Distance between circular targets on D2 (mm): 100 mm
3. **FMVSS 208 Dummy Targeting Requirements**
- 3.1 Place a circular target with black and yellow quadrants on both sides of the driver dummy head as close as possible to the center of gravity of the head in the x and z direction (relative to the measuring directions of the accelerometers).
- 3.2 Place a circular target with black and yellow quadrants on both sides of the passenger dummy head as close as possible to the center of gravity of the head in the x and z direction (relative to the measuring directions of the accelerometers).
- 3.3 Place a circular target with black and yellow quadrants on the outboard shoulder of the driver dummy. Place the target as high up on the arm as possible at the intersection of the arm and shoulder. The sleeve of the shirt on the dummy may be cut to make the target visible, but do not remove any material.
- 3.4 Place a circular target with black and yellow quadrants on the outboard shoulder of the passenger dummy. Place the target as high up on the arm as possible at the intersection of the arm and shoulder. The sleeve of the shirt on the dummy may be cut to make the target visible, but do not remove any material.
4. **FMVSS 204 Targeting Requirements**
- 4.1 Is an FMVSS 204 indicant test ordered on the "COTR Vehicle Work Order?"
- Yes, continue with this form.
- No, this form is complete.
- 4.2 Resection panel (Figure 28C)
- 4.2.1 The panel deviates no more than 6 mm from perfect flatness when suspended vertically
- 4.2.2 The 8 targets on the panel are circular targets at least 90 mm in diameter and with black and yellow quadrants.
- 4.2.3 The center of each of the 4 outer targets are placed within 1 mm of the corners of a square measuring 914 mm on each side.
- 4.2.4 Locate another square with 228 mm sides and with the center of this square coincident with the center of the 914 mm square.
- 4.2.5 The center of the 4 inner targets are placed at the midpoints of each of the 228 mm sides.
- 4.3 Place a circular target at least 90 mm in diameter and with black and yellow quadrants on a material (cardboard, metal, etc.) that can be taped to the top of the steering column.
- 4.4 Tape the target from 4.3 to the top of the steering column in a manner that does not interfere with the movement of the steering column in a crash.

REMARKS:

Signature: Clad Wellin Date: 9/19/23

I certify that I have read and performed each instruction.

# REFERENCE PHOTO TARGETS

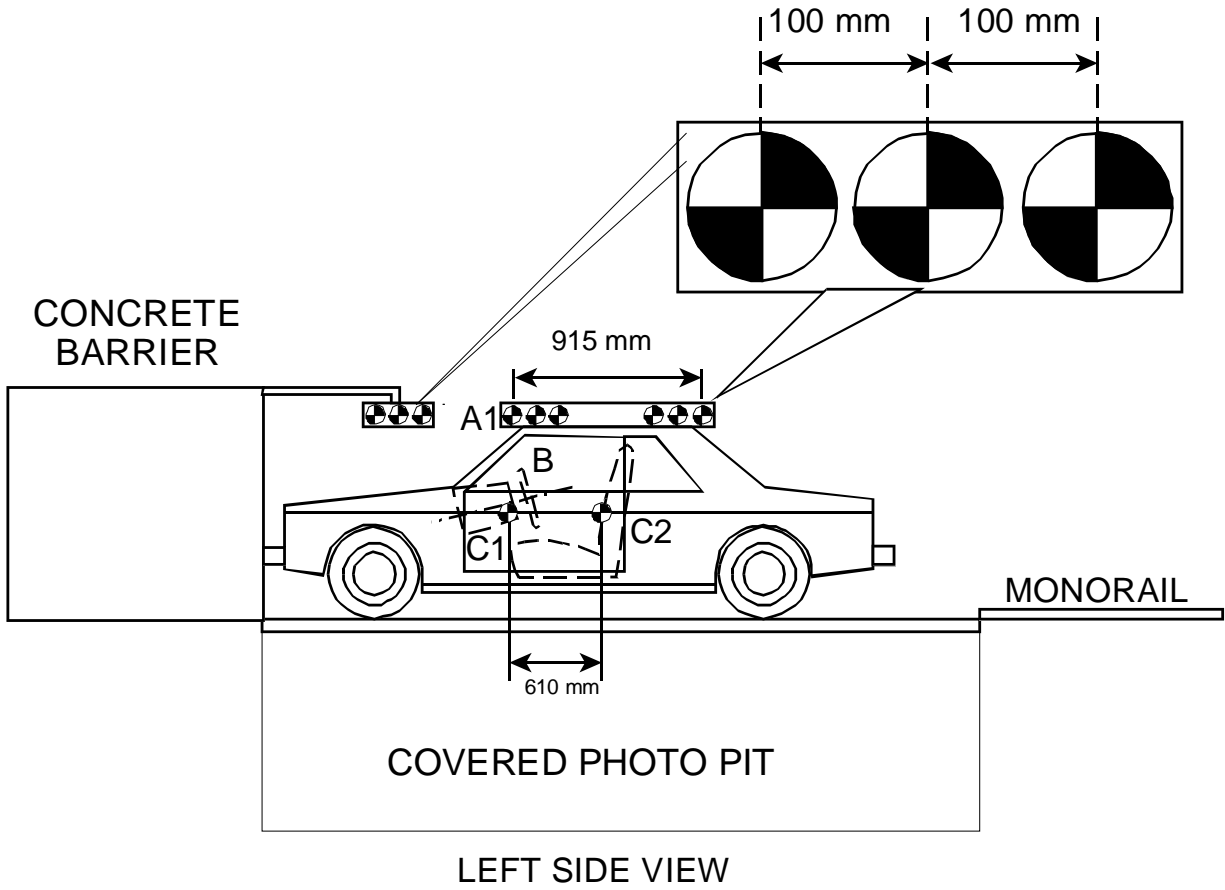

# RESECTION PANEL TARGETING ALIGNMENT

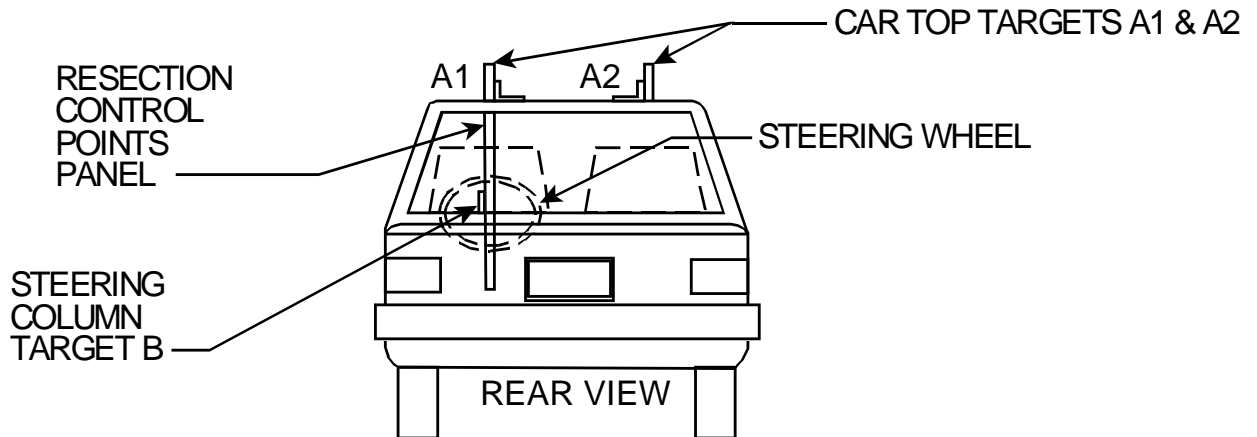

## TEST RUN STEERING COLUMN CAMERA VIEW OF TYPICAL TIME ZERO VEHICLE POSITION

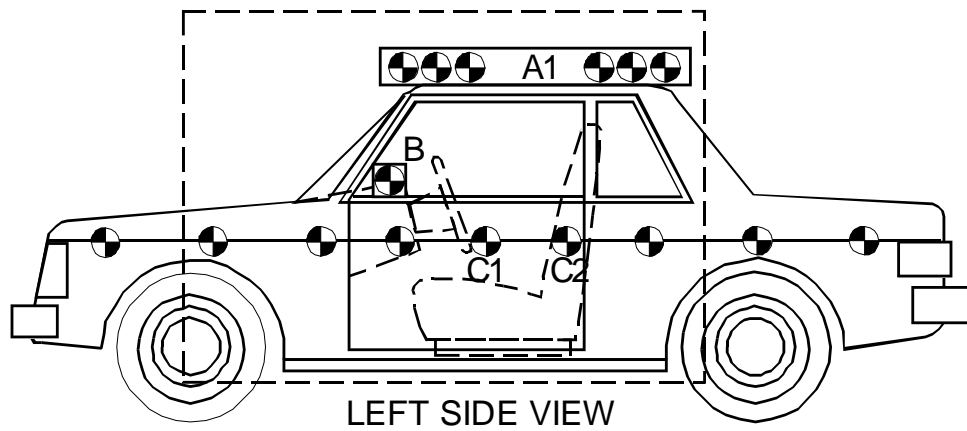

# PRE-RUN STEERING COLUMN HIGH SPEED CAMERA VIEW

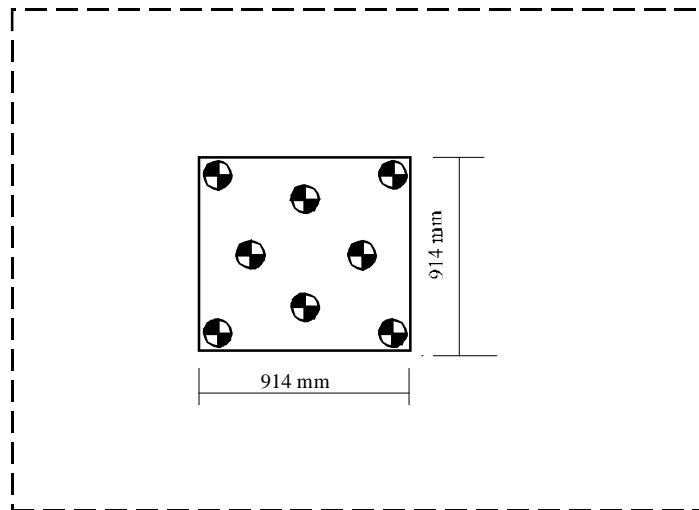

LEFT SIDE VIEW

**DATA SHEET 35**  
**CAMERA LOCATIONS**

Test Vehicle: 2023 Volvo XC40  
Test Program: FMVSS 208 Compliance

NHTSA No.: C20235900  
Test Date: 9/19/23  
Time: 11:20 am

CAMERA NO.	VIEW	CAMERA POSITIONS (mm) *			LENS (mm)	SPEED (fps)
		X	Y	Z		
1	Real Time Left Side View				13	30
2	Left Side View (Barrier face to front seat backs)	1230	-5380	1530	24	1000
3	Left Side View (Driver)	1750	-7050	1870	50	1000
4	Left Side View (B-post aimed toward center of steering wheel)	7520	-5880	1950	75	1000
5	Left Side View (Steering Column)	900	-5350	1230	50	1000
6	Left Side View (Steering Column)	770	-5360	790	50	1000
7	Right Side View (Overall)	2110	5900	1570	16	1000
8	Right Side View (Passenger)	1460	6970	1780	50	1000
9	Right Side View (Angle)	7670	5390	2030	75	1000
10	Right Side View (Front door)	1110	5490	1450	24	1000
11	Front View Windshield	120	0	2310	11	1000
12	Front View Driver	60	-370	2230	25	1000
13	Front View Passenger	60	370	2230	25	1000
14	Overhead Barrier Impact View	3000	0	6820	11	1000
15	Pit Camera Engine View	1000	0	-3340	24	1000
16	Pit Camera Fuel Tank View	2990	0	-3340	24	1000

\*COORDINATES:

- +X - forward of impact plane
- +Y - right of monorail centerline
- +Z - above ground level

# CAMERA POSITIONS FOR FMVSS 208

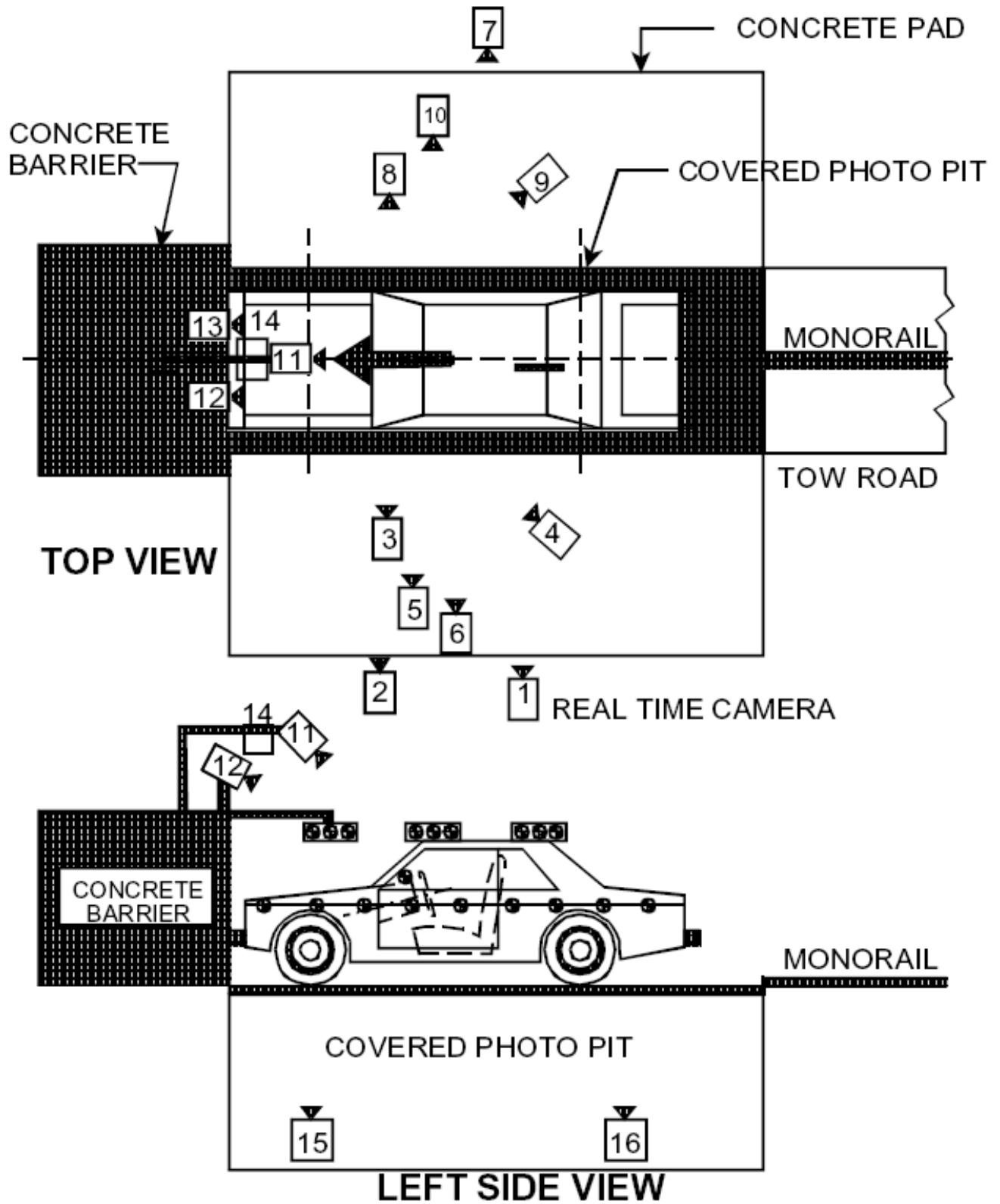

**DATA SHEET 36 - APPENDIX G**  
**DUMMY POSITIONING PROCEDURES**  
**FOR 5<sup>th</sup> PERCENTILE FEMALE DRIVER TEST DUMMY**  
**CONFORMING TO SUBPART O OF PART 572**

Test Vehicle: 2023 Volvo XC40 NHTSA No.: C20235900  
 Test Program: FMVSS 208 Compliance Test Date: 9/19/23  
 Test Technician: Keegan Strockis

IMPACT ANGLE:	0°			
BELTED DUMMIES (YES/NO):	YES			
TEST SPEED:	<input type="checkbox"/> 32 to 40 kmph	<input type="checkbox"/> 0 to 48 kmph	<input checked="" type="checkbox"/> 0 to 56 kmph	
DRIVER DUMMY:	<input checked="" type="checkbox"/> X	5 <sup>th</sup> female		50 <sup>th</sup> male
PASSENGER DUMMY:	<input checked="" type="checkbox"/> X	5 <sup>th</sup> female		50 <sup>th</sup> male

**1. Seat Position**

- X 1.1 Position the seat's adjustable lumbar supports so that the lumbar supports are in the lowest, retracted or deflated adjustment positions. (S16.2.10.1, S20.1.9.1, S20.4.1, S22.1.7.1)  
   N/A – No lumbar adjustment
- X 1.2 Position any adjustable parts of the seat that provide additional support so that they are in the lowest or most open adjustment position. (S16.2.10.2, S20.1.9.2, S20.4.1, S22.1.7.1, S22.4.2.1, S22.4.3.1, S24.4.2.1, S26.2.3, S26.3.1)  
X N/A – No additional support adjustment
- X 1.3 Position an adjustable leg support system in its rearmost position. (8/27/04 interpretation to Toyota)  
X N/A – No adjustable leg support system
- X 1.4 **Mark** a point (seat cushion reference point) on the side of the seat cushion that is between 150 mm and 250 mm from the front edge of the seat cushion. (S16.3.1.12)
- X 1.5 Draw a line (seat cushion reference line) through the seat cushion reference point. (S16.3.1.13)
- X 1.6 Use only the controls that primarily move the seat in the fore-aft direction to move the seat cushion reference point to the rearmost position. (S16.2.10.3.1, S22.1.7.3)
- X 1.7 If the seat cushion adjusts fore-aft, independent of the seat back, use only the controls that primarily move the seat cushion in the fore-aft direction to move the seat cushion reference point to the rearmost position. (S16.2.10.3.1, S20.1.9.3)  
X N/A – No independent fore-aft seat cushion adjustment
- X 1.8 Use any part of any control, other than the parts just used for fore-aft positioning, to determine the range of angles of the seat cushion reference line and to set the seat cushion reference line at the mid-angle. (S16.2.10.3.1)  
 Maximum angle: 25.3°  
 Minimum angle: 11.6°  
 Mid-angle: 18.5°

- 1.9 If the seat and/or seat cushion height is adjustable, use any part of any control other than the parts which primarily move the seat or seat cushion fore-aft, to put the seat cushion reference point in its lowest position with the seat cushion reference line angle at the mid-angle found in 1.8. (S16.2.10.3.1)  
 N/A – No seat height adjustment
- 1.10 Use only the controls that primarily move the seat in the fore-aft direction to verify the seat is in the rearmost position.
- 1.11 Use only the controls that primarily move the seat in the fore-aft direction to **mark** the fore-aft seat positions. **Mark** each position so that there is a visual indication when the seat is at a particular position. For manual seats, move the seat forward one detent at a time and **mark** each detent. For power seats, **mark** only the rearmost, middle, and foremost positions. Label three of the positions with the following: F for foremost, M for mid-position (if there is no mid-position, label the closest adjustment position to the rear of the mid-point), and R for rearmost.
- 1.12 Use only the controls that primarily move the seat in the fore-aft direction to place the seat in the rearmost position.
- 1.13 Use any part of any control, other than the parts which primarily move the seat or seat cushion fore-aft, to find and visually **mark** the maximum, minimum, and middle height of the seat cushion reference point with the seat cushion reference line at the mid-angle determined in 1.8. (S20.1.9.4, S22.1.2, S22.1.7.4, S22.3.1, S22.4.3.1, S24.1.2, S24.3.1, S24.4.3.1, S26.2.3, S26.3.1)  
 N/A – No seat height adjustment. Go to 1.18
- 1.14 Use only the controls that primarily move the seat and/or seat cushion in the fore-aft direction to place the seat in the mid-fore-aft position.
- 1.15 Use any part of any control, other than the parts which primarily move the seat or seat cushion fore-aft, to find and visually **mark** the maximum, minimum, and middle height of the seat cushion reference point with the seat cushion reference line at the mid-angle determined in 1.8. (S20.1.9.4, S22.1.2, S22.1.7.4, S22.3.1, S24.1.2, S24.3.1)
- 1.16 Use only the control that change the seat in the fore-aft direction to place the seat in the foremost position. (S16.2.10.3.2)
- 1.17 Use any part of any control, other than the parts which primarily move the seat or seat cushion fore-aft, to find and visually **mark** the maximum, minimum, and middle height of the seat cushion reference point with the seat cushion reference line at the mid-angle determined in 1.8. (S16.2.10.3.3, S20.1.9.4, S22.1.2, S22.1.7.4, S22.3.1, S24.1.2, S24.3.1)
- 1.18. Is the seat a bucket seat?  
 Yes, go to 1.19 and skip 1.20  
 No, go to 1.20 and skip 1.19
- 1.19 Bucket seats:  
Locate and **mark** for future reference the longitudinal centerline of the seat cushion. The intersection of the vertical longitudinal plane that passes through the SgRP and the seat cushion upper surface determines the longitudinal centerline of a bucket seat cushion. (S16.3.1.10 & S20.1.10)

1.20 Bench seats (complete ONLY the one that is applicable to the seat being marked):  
Locate and **mark** for future reference the longitudinal line on the seat cushion that marks the intersection of the vertical longitudinal plane through the centerline of the steering wheel and the seat cushion upper surface.

## 2. Head Restraint Position

N/A Vehicle contains automatic head restraints.

N/A, there is no head restraint adjustment Go to 3

2.1 Adjust the head restraint to its lowest position. (S16.2.10.2, S20.1.9.6, S20.4.1, S22.1.7.6, S22.4.2.1, S22.4.3.1, S24.4.3.1, S26.2.3, S26.3.1)

2.2 All adjustments of the head restraint shall be used to position it full forward. For example, if it rotates, rotate it such that the head restraint extends as far forward as possible. **Mark** the foremost position. (S16.2.10.2 & S16.3.4.4 & S20.1.9.6, S20.4.1, S22.4.2.1, S22.4.3.1, S24.4.3.1, S26.2.3, S26.3.1)

2.3 Measure the vertical distance from the top most point of the head restraint to the bottom most point. Locate and **mark** a horizontal plane through the midpoint of this distance. (S16.3.4.3)

Vertical height of head restraint: 220 mm

Mid-point height: 110 mm

3. Is the **steering wheel** adjustable up and down and/or in and out?

Yes – go to 3.1

No – Go to 4

3.1. Find and **mark** for future reference each up and down position. Label three of the positions with the following: H for highest, M for mid-position (if there is no mid-position, label the next lowest adjustment position), and L for lowest.  
 N/A – steering wheel is not adjustable up and down

3.2. Find and **mark** for future references each in and out position. Label three of the Positions with the following: F for foremost, M for mid-position (if there is no mid-position, label the next rearmost adjustment position), and R for rearmost.  
 N/A – steering wheel is not adjustable in and out.

3.3. Use the markings to position the steering controls in the mid-position or if applicable next lowest detent position. (S16.2.9)

4. Place the SCRP in the full rearward, mid-height position, and mid-seat cushion angle, determined in Item 1. (S16.3.2.1.1)

5. If the vehicle has an adjustable accelerator pedal, place it in the full forward position. (S16.3.2.2.1)  
 N/A accelerator pedal not adjustable

6. Fully recline the seat back. (S16.3.2.1.2)  
 N/A seat back not adjustable.

7. Place the dummy in the seat with the legs at an angle of 120 degrees to the thighs. The calves should not be touching the seat cushion. (S16.3.2.1.2)

8. Position the dummy in the seat such that the midsagittal plane is coincident with the longitudinal seat cushion markings as determined in Item 1.19 or 1.20. (S16.3.2.1.3 and S16.3.2.1.4)

9. Hold down the dummy's thighs and push rearward on the upper torso to maximize the pelvic angle. (S16.3.2.1.5)
10. Set the angle between the legs and the thighs to 120 degrees. (S16.3.2.1.6)
11. Set the transverse distance between the centers of the front of the knees at 160 to 170 mm. (6.3 to 6.7 inches) Center the knee separation with respect to the longitudinal seat cushion marking as determined in Item 1.19 or 1.20. (S16.3.2.1.6)  
Record Knee Separation: 165 mm
12. Push rearward on the dummy's knees until the pelvis contacts the seat back, or the backs of the calves contact the seat cushion, whichever occurs first. (S16.3.2.1.6)  
 Pelvis contacted seat back.  
 Calves contacted seat cushion.
13. Gently rock the upper torso  $\pm 5$  degrees (approximately 51 mm (2 inches)) side-to-side three times. (S16.3.2.1.7)
14. If needed, extend the legs until the feet do not contact the floor pan. The thighs should be resting on the seat cushion. (S16.3.2.1.8)
15. Position the right foot until the foot is in line with a longitudinal vertical plane passing through the center of the accelerator pedal. Maintain the leg and thigh in a vertical plane. (S16.3.2.1.8)
16. Rotate the left leg and thigh laterally to equalize the distance between each knee and the longitudinal seat cushion marking as determined in Item 1.19 or 1.20. (S16.3.2.1.8)
17. Attempt to return the seat to the foremost fore-aft position, mid-height, and seat cushion mid-angle as determined in Item 1. The foot may contact and depress the accelerator and/or change the angle of the foot with respect to the leg. (S16.3.2.1.8)  
 Foremost position achieved. Proceed to step 22.  
 Foremost not achieved because of foot interference. Proceed to step 19.  
 Foremost not achieved because of steering wheel contact.
18. If either of the dummy's legs contact the steering wheel, move the steering wheel up the minimum amount required to avoid contact. If the steering wheel is not adjustable separate the knees the minimum required to avoid contact. (S16.3.2.1.8)  
 N/A- there was no leg contact  
 Steering wheel repositioned  
 Knees separated
19. If the left foot interferes with the clutch or brake pedals, rotate the left foot about the leg to provide clearance. If this is not sufficient, rotate the thigh outboard at the hip the minimum amount required for clearance. (S16.3.2.1.8)  
 N/A, No foot interference with pedals.  
 Foot adjusted to provide clearance.  
 Foot and Thigh adjusted to provide clearance.

20. Continue to move the seat. Use seat controls to line up the seat markings determined during item 1 to set the foremost fore-aft position, mid-height position and the seat cushion mid-angle. If the dummy contacts the interior move the seat rearward until a maximum clearance of 5 mm (0.2 inches) is achieved or the seat is in the closest detent position that does not cause dummy contact. (S16.3.2.1.8)

  Foremost, mid-height position and the seat cushion mid-angle reached

  Dummy contact. Clearance set at maximum of 5 mm

Measured Clearance: \_\_\_\_\_

  Dummy Contact. Seat set at nearest detent position.

Seat position:    detent positions rearward of foremost  
(foremost is position zero)

  21. If the steering wheel was repositioned in step 18, return the steering wheel to the original position. If the steering wheel contacts the dummy before reaching the original position, position the wheel until a maximum clearance of 5 mm (.2 inches) is achieved, or the steering wheel is in the closest detent position that does not cause dummy contact. (S16.3.2.1.8)

  N/A Steering wheel was not repositioned.

  Original position achieved.

  Dummy contact. Clearance set at maximum of 5 mm

Measured Clearance: \_\_\_\_\_

  Dummy Contact. Steering wheel set at nearest detent position.

Steering wheel position:    detent positions upward of original position.  
(Original position is position zero)

X22. If the seat back is adjustable, rotate the seat back forward while holding the thighs in place. Continue rotating the seat back forward until the transverse instrument platform of the dummy head is level  $\pm 0.5$  degrees. If the head cannot be leveled using the seat back adjustment, or the seat back is not adjustable, use the lower neck bracket adjustment to level the head. If a level position cannot be achieved, minimize the angle. (S16.3.2.1.9)

X Head Level Achieved. (Check all that apply)

X Head leveled using the adjustable seat back

   Head leveled using the neck bracket.

Head Angle: 0.0 degrees

   Head Level NOT Achieved. (Check all that apply)

   Head adjusted using the adjustable seat back

   Head adjusted using the neck bracket.

Head Angle: \_\_\_\_\_ degrees

X23. Verify the pelvis is not interfering with the seat bight. (S16.3.2.1.9)

X No interference

   Pelvis moved forward the minimum amount so that it is not caught in the seat bight.

X24. Verify the dummy abdomen is properly installed. (S16.3.2.1.9)

X Abdomen still seated properly into dummy

   Abdomen was adjusted because it was not seated properly into dummy

X25. Head Angle

X N/A, neither the pelvis nor the abdomen were adjusted.

X25.1 Head still level (Go to 26)

25.2 Head level adjusted

Head Level Achieved. (Check all that apply)

Head leveled using the adjustable seat back

Head leveled using the neck bracket.

Head Angle: \_\_\_\_\_ degrees

Head Level NOT Achieved. (Check all that apply)

Head level adjusted using the adjustable seat back

Head level adjusted using the neck bracket.

Head Angle: \_\_\_\_\_ degrees

X 26. If the dummy torso contacts the steering wheel while performing step 22, reposition the steering wheel in the following order to eliminate contact. (S16.3.2.1.9)

X N/A, No dummy torso contact with the steering wheel.

26.1 Adjust telescoping mechanism.

N/A No telescoping adjustment.

Adjustment performed (fill in appropriate change)

Steering wheel moved \_\_\_\_\_ detent positions in the forward direction.

Steering wheel moved \_\_\_\_\_ mm in the forward direction.

26.2 Adjust tilt mechanism.

N/A No tilt adjustment.

No adjustment performed.

Adjustment performed. (circle one)

Steering wheel moved \_\_\_\_\_ detent positions Upward/Downward.

Steering wheel moved \_\_\_\_\_ degrees Upward/Downward

26.3 Adjust Seat in the aft direction.

No Adjustment performed.

Seat moved aft \_\_\_\_\_ mm from original position.

Seat moved aft \_\_\_\_\_ detent positions from the original position.

X 27. Measure and set the pelvic angle using the pelvic angle gage TE-2504. The pelvic angle should be 20.0 degrees  $\pm$  2.5 degrees. If the pelvic angle cannot be set to the specified range because the head will not be level or because the dummy will have need major repositioning, adjust the pelvis as closely as possible to the angle range, but keep the head level. (S16.3.2.1.11)

X Pelvic angle set to 20.0 degrees  $\pm$  2.5 degrees.

Pelvic angle of 20.0 degrees not achieved, the angular difference was minimized.

X Record the pelvic angle: 21.3 degrees

X 28. Check the dummy for contact with the interior after completing adjustments. (S16.3.2.1.12)

X No contact.

Dummy in contact with interior.

Seat moved aft \_\_\_\_\_ mm from the previous position.

Seat moved aft \_\_\_\_\_ detent positions from the previous position.

X 29. Check the dummy to see if additional interior clearance is obtained, allowing the seat to be moved forward. (S16.3.2.1.12)

X N/A, Seat already at foremost position.

Clearance unchanged. No adjustments required.

Additional clearance available

Seat moved Forward \_\_\_\_\_ mm from the previous position.

Seat moved Forward \_\_\_\_\_ detent positions from the previous position.

30. Driver's foot positioning, right foot. Place the foot perpendicular to the leg and determine if the heel contacts the floor pan at any leg position. If the heel contacts the floor pan proceed to step 31 otherwise, proceed to step 32. (S16.3.2.2.1)
31. Perform the following steps until either all steps are completed, or the foot contacts the accelerator pedal. Step 31.6 shall be completed in all cases. (S16.3.2.2.1(a))
- 31.1 With the rear of the heel contacting the floor pan, move the foot forward until pedal contact occurs or the foot is at the full forward position.
- 31.2 If the vehicle has an adjustable accelerator pedal, move the pedals rearward until pedal contact occurs or the pedals reach the full rearward position.
- 31.3 Extend the leg, allowing the heel to lose contact with the floor until the foot contacts the pedal. Do not raise the toe of the foot higher than the top of the accelerator pedal. If the foot does not contact the pedal, proceed to the next step. If pedal contact does occur, place a tapered foam block as shown in Figure G1 under the heel with the shallow part of the taper facing forward. (S16.3.2.2.3)
- 31.4 Angle the foot to achieve contact between the foot and the pedal. If the foot does not contact the pedal, return the foot to the perpendicular orientation. If pedal contact does occur, place a tapered foam block as shown in Figure G1 under the heel with the shallow part of the taper facing forward. (S16.3.2.2.3)
- 31.5 Align the centerline of the foot with the vertical-longitudinal plane passing through the center of the accelerator pedal. Place a tapered foam block as shown in Figure G1 under the heel with the shallow part of the taper facing forward. (S16.3.2.2.3)
- 31.6 Record foot position
- Pedal Contact achieved. Contact occurred at step 31.1
    - Heel contacts floor pan
    - Heel set \_\_\_\_\_ mm from floor pan.
  - Pedal Contact not achieved. Heel set \_\_\_\_\_ mm from the floor pan.

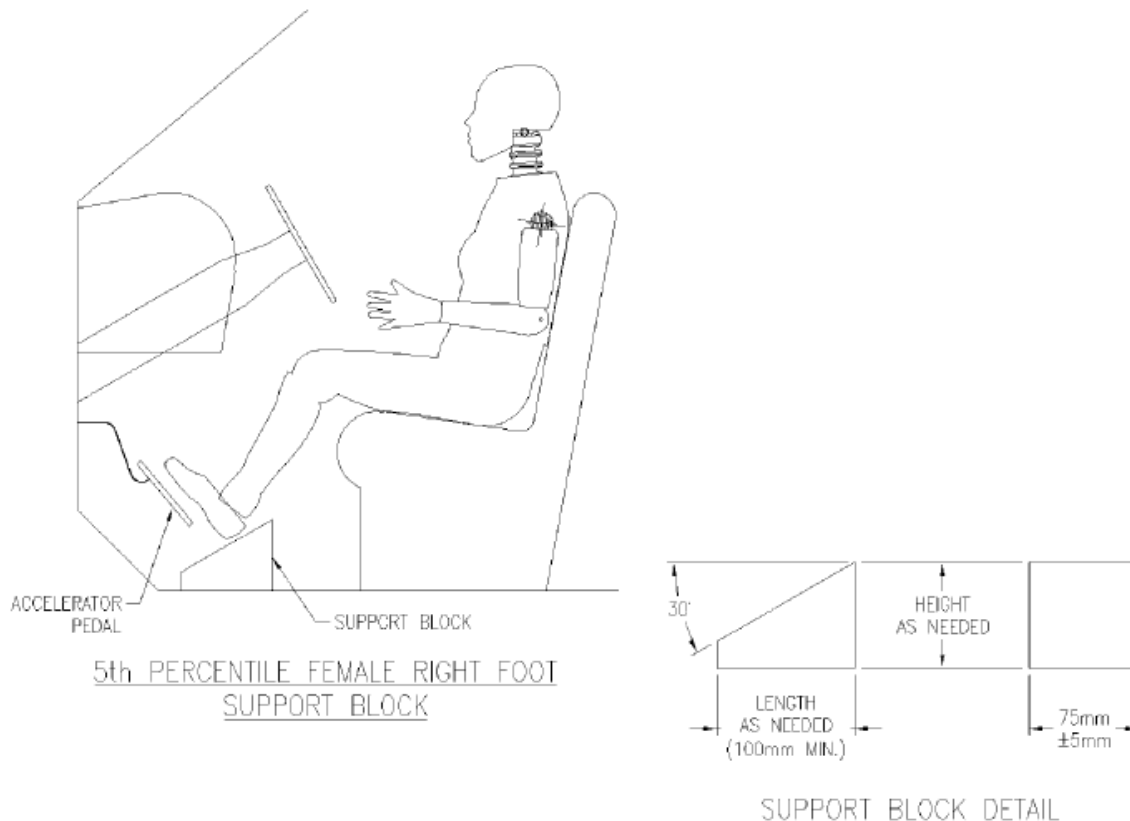

**FIGURE G1**

32. Perform the following steps until either all steps are completed, or the foot contacts the accelerator pedal. Step 32.5 shall be completed in all cases.

32.1 Extend the leg until the foot contacts the pedal. Do not raise the toe of the foot higher than the top of the accelerator pedal. If the foot does not contact the pedal, proceed to the next step. If pedal contact does occur, place a tapered foam block as shown in Figure G1 under the heel with the shallow part of the taper facing forward. (S16.3.2.2.1(b) & S16.3.2.2.3)

32.2 If the vehicle has an adjustable accelerator pedal, move the pedals rearward until pedal contact occurs or the pedals reach the full rearward position. If pedal contact does occur, place a tapered foam block as shown in Figure G1 under the heel with the shallow part of the taper facing forward. (S16.3.2.2.1(b) & S16.3.2.2.3)  
 N/A No pedal adjustment

32.3 Angle the foot to achieve contact between the foot and the pedal. If the foot does not contact the pedal, return the foot to the perpendicular orientation. If pedal contact does occur, place a tapered foam block as shown in Figure G1 under the heel with the shallow part of the taper facing forward. (S16.3.2.2.2 & S16.3.2.2.3)

32.4 Align the centerline of the foot in the same horizontal plane as the centerline of the accelerator pedal. Place a tapered foam block as shown in Figure G1 under the heel with the shallow part of the taper facing forward. (S16.3.2.2.3)

32.5 Record foot position

Pedal Contact achieved. Contact occurred at step 31.1.

Heel set \_\_\_\_\_ mm from floor pan.

Pedal Contact not achieved. Heel set \_\_\_ mm from the floor pan.

X 33. Driver's foot positioning, left foot.

X 33.1 Place the foot perpendicular to the leg and determine if the heel contacts the floor pan at any leg position. If the heel contacts the floor pan proceed to step 33.2, otherwise position the leg as perpendicular to the thigh as possible with the foot parallel to the floor pan. (S16.2.2.6)

X 33.2 Place the foot on the toe board with the heel resting on the floor pan as close to the intersection of the floor pan and the toe board as possible. Adjust the angle of the foot if necessary to contact the toe board. If the foot will not contact the toe board, set the foot perpendicular to the leg, and set the heel on the floor pan as far forward as possible. Avoid contact with the brake pedal, clutch pedal, wheel well projection, and footrest. To avoid this contact use the following three manipulations in the order listed, with each subsequent option incorporating the previous, until contact is avoided: rotate the foot about the lower leg (abduction/adduction), plantar flex the foot, rotate the leg outboard about the hip. Movement should be the minimum amount necessary. If it is not possible to avoid all foot contact, give priority to avoiding brake or clutch pedal contact. (S16.2.2.4 & S16.2.2.5 & S16.2.2.7)

X No contact

  Foot rotated about the leg (abduction/adduction)

  Foot rotated about the leg, and foot plantar flexed

  Foot rotated about the leg, foot plantar flexed, and the leg rotated about the hip.

X 33.3 Record foot position.

  Heel does not contact floor pan.

  Heel on floor pan and foot on toe board.

X Heel on floor pan and foot not on toe board.

X 34. Driver arm/hand positioning.

X 34.1 Place the dummy's upper arms adjacent to the torso with the arm centerlines as close to a vertical longitudinal plane as possible. (S16.3.2.3.1)

X 34.2 Place the palms of the dummy in contact with the outer part of the steering wheel rim at its horizontal centerline with the thumbs over the steering wheel rim. (S16.3.2.3.2)

X 34.3 If it is not possible to position the thumbs inside the steering wheel rim at its horizontal centerline, then position them above and as close to the horizontal centerline of the steering wheel rim as possible. (S16.3.2.3.3)

X 34.4 Lightly tape the hands to the steering wheel rim so that if the hand of the test dummy is pushed upward by a force of not less than 9 N (2 lb) and not more than 22 N (5 lb), the tape releases the hand from the steering wheel rim. (S16.3.2.3.4)

X 35. Adjustable head restraints

  N/A, there is no head restraint adjustment

   35.1 If the head restraint has an automatic adjustment, leave it where the system positions the restraint after the dummy is placed in the seat. (S16.3.4.1) Go to 36.

   35.2 Adjust each head restraint vertically so that the mid-horizontal plane determined in Item 2 is aligned with the center of gravity (CG) of the dummy head. (S16.3.4.3)

35.3 If the above position is not attainable, move the vertical center of the head restraint to the closest detent below the center of the head CG. (S16.3.4.3)

N/A midpoint position attained in previous step

Headrest set at nearest detent below the head CG

35.4 If the head restraint has a fore and aft adjustment, place the restraint in the foremost position or until contact with the head is made, whichever occurs first. (S16.3.4.4)

36. Driver and passenger manual belt adjustment (for tests conducted with a belted dummy). (S16.3.5)

N/A Dummies are unbelted for this test.

36.1 If an adjustable seat belt D-ring anchorage exists, place it in the manufacturer's design position for a 5th percentile adult female. (S16.3.5.1) **This information will be supplied by the COTR.**

Manufacturer's specified position: 0 of 4; Upper-most defined as 0

Actual Position: 0 of 4; Upper-most defined as 0

36.2 Place the Type 2 manual belt around the test dummy and fasten the latch. (S16.3.5.2)

36.3 Ensure that the dummy's head remains as level as possible. (S16.3.5.3)

36.4 Remove all slack from the lap belt. Pull the upper torso webbing out of the retractor and allow it to retract; repeat this operation four times. Apply a 9 N (2 lbf) to 18 N (4 lbf) tension load to the lap belt. If the belt system is equipped with a tension-relieving device, introduce the maximum amount of slack into the upper torso belt that is recommended by the manufacturer. If the belt system is not equipped with a tension-relieving device, allow the excess webbing in the shoulder belt to be retracted by the retractive force of the retractor. (S16.3.5.4)

I certify that I have read and performed each instruction.

Signature: Keegan Atacker

Date: 9/19/23

**DATA SHEET 36 - APPENDIX G**  
**DUMMY POSITIONING PROCEDURES**

**FOR 5<sup>th</sup> PERCENTILE FEMALE PASSENGER TEST DUMMY**  
**CONFORMING TO SUBPART O OF PART 572**

Test Vehicle:	<u>2023 Volvo XC40</u>	NHTSA No.:	<u>C20235900</u>
Test Program:	<u>FMVSS 208 Compliance</u>	Test Date:	<u>9/19/23</u>
Test Technician:	<u>Keegan Strockis</u>		

IMPACT ANGLE:	0°			
BELTED DUMMIES (YES/NO):	YES			
TEST SPEED:	32 to 40 kmph	0 to 48 kmph	<input checked="" type="checkbox"/>	0 to 56 kmph
DRIVER DUMMY:	<input checked="" type="checkbox"/>	5 <sup>th</sup> female		50 <sup>th</sup> male
PASSENGER DUMMY:	<input checked="" type="checkbox"/>	5 <sup>th</sup> female		50 <sup>th</sup> male

     **The passenger seat adjustments are controlled by the adjustments made to the driver’s seat. Therefore, positioning of the passenger dummy is made simultaneously with the driver dummy. Adjustments made to the seat to position the driver will override any adjustments that would normally be made to position the passenger. (S16.2.10.3)**

**1. Seat Position**

X 1.1 Position the seat’s adjustable lumbar supports so that the lumbar supports are in the lowest, retracted or deflated adjustment positions. (S16.2.10.1, S20.1.9.1, S20.4.1, S22.1.7.1)  
     N/A – No lumbar adjustment

X 1.2 Position any adjustable parts of the seat that provide additional support so that they are in the lowest or most open adjustment position. (S16.2.10.2, S20.1.9.2, S20.4.1, S22.1.7.1, S22.4.2.1, S22.4.3.1, S24.4.2.1, S26.2.3, S26.3.1)  
X N/A – No additional support adjustment

X 1.3 Position an adjustable leg support system in its rearmost position. (8/27/04 interpretation to Toyota)  
X N/A – No adjustable leg support system

X 1.4 **Mark** a point (seat cushion reference point) on the side of the seat cushion that is between 150 mm and 250 mm from the front edge of the seat cushion. (S16.3.1.12)

X 1.5 Draw a line (seat cushion reference line) through the seat cushion reference point. (S16.3.1.13)

X 1.6 Use only the controls that primarily move the seat in the fore-aft direction to move the seat cushion reference point to the rearmost position. (S16.2.10.3.1, S22.1.7.3)

X 1.7 If the seat cushion adjusts fore-aft, independent of the seat back, use only the controls that primarily move the seat cushion in the fore-aft direction to move the seat cushion reference point to the rearmost position. (S16.2.10.3.1, S20.1.9.3)  
X N/A – No independent fore-aft seat cushion adjustment

- 1.8 Use any part of any control, other than the parts just used for fore-aft positioning, to determine the range of angles of the seat cushion reference line and to set the seat cushion reference line at the mid-angle. (S16.2.10.3.1)  
Maximum angle: 22.4°  
Minimum angle: 9.1°  
Mid-angle: 15.8°
- 1.9 If the seat and/or seat cushion height is adjustable, use any part of any control other than the parts which primarily move the seat or seat cushion fore-aft, to put the seat cushion reference point in its lowest position with the seat cushion reference line angle at the mid-angle found in 1.8. (S16.2.10.3.1)  
 N/A – No seat height adjustment
- 1.10 Use only the controls that primarily move the seat in the fore-aft direction to verify the seat is in the rearmost position.
- 1.11 Use only the controls that primarily move the seat in the fore-aft direction to **mark** the fore-aft seat positions. **Mark** each position so that there is a visual indication when the seat is at a particular position. For manual seats, move the seat forward one detent at a time and **mark** each detent. For power seats, **mark** only the rearmost, middle, and foremost positions. Label three of the positions with the following: F for foremost, M for mid-position (if there is no mid-position, label the closest adjustment position to the rear of the mid-point), and R for rearmost.
- 1.12 Use only the controls that primarily move the seat in the fore-aft direction to place the seat in the rearmost position.
- 1.13 Use any part of any control, other than the parts which primarily move the seat or seat cushion fore-aft, to find and visually **mark** the maximum, minimum, and middle height of the seat cushion reference point with the seat cushion reference line at the mid-angle determined in 1.8. (S20.1.9.4, S22.1.2, S22.1.7.4, S22.3.1, S22.4.3.1, S24.1.2, S24.3.1, S24.4.3.1, S26.2.3, S26.3.1)  
 N/A – No seat height adjustment. Go to 1.18
- 1.14 Use only the controls that primarily move the seat and/or seat cushion in the fore-aft direction to place the seat in the mid-fore-aft position.
- 1.15 Use any part of any control, other than the parts which primarily move the seat or seat cushion fore-aft, to find and visually **mark** the maximum, minimum, and middle height of the seat cushion reference point with the seat cushion reference line at the mid-angle determined in 1.8. (S20.1.9.4, S22.1.2, S22.1.7.4, S22.3.1, S24.1.2, S24.3.1)
- 1.16 Use only the controls that change the seat in the fore-aft direction to place the seat in the foremost position. (S16.2.10.3.2)
- 1.17 Use any part of any control, other than the parts which primarily move the seat or seat cushion fore-aft, to find and visually **mark** the maximum, minimum, and middle height of the seat cushion reference point with the seat cushion reference line at the mid-angle determined in 1.8. (S16.2.10.3.3, S20.1.9.4, S22.1.2, S22.1.7.4, S22.3.1, S24.1.2, S24.3.1)
- 1.18. Is the seat a bucket seat?  
 Yes, go to 1.19 and skip 1.20  
 No, go to 1.20 and skip 1.19

X 1.19 Bucket seats:

Locate and **mark** for future reference the longitudinal centerline of the seat cushion. The intersection of the vertical longitudinal plane that passes through the SgRP and the seat cushion upper surface determines the longitudinal centerline of a bucket seat cushion. (S16.3.1.10 & S20.1.10)

   1.20 Bench seats:

Locate and **mark** the longitudinal centerline of the passenger seat cushion. The longitudinal centerline is the same distance from the longitudinal centerline of the vehicle as the center of the steering wheel. (S20.2.1.4, S22.2.1.3, S24.2.3, S20.4.4, S22.2.2.1 (b), S22.2.2.3 (b), S22.2.2.4 (a), S22.2.2.5 (a), S22.2.2.6 (a), S22.2.2.7 (a), S24.2.3 (a))

Record the distance from the longitudinal centerline of the vehicle to the center of the steering wheel. \_\_\_\_\_

Record the distance from the longitudinal centerline of the vehicle to the longitudinal centerline of the seat cushion. (The vertical plane through this longitudinal centerline is Plane B for suppression.) \_\_\_\_\_

## 2. Head Restraint Position

   N/A Vehicle contains automatic head restraints.

   N/A, there is no head restraint adjustment Go to 3

X 2.1 Adjust the head restraint to its lowest position. (S16.2.10.2, S20.1.9.6, S20.4.1, S22.1.7.6, S22.4.2.1, S22.4.3.1, S24.4.3.1, S26.2.3, S26.3.1)

X 2.2 All adjustments of the head restraint shall be used to position it full forward. For example, if it rotates, rotate it such that the head restraint extends as far forward as possible. **Mark** the foremost position. (S16.2.10.2 & S16.3.4.4 & S20.1.9.6, S20.4.1, S22.4.2.1, S22.4.3.1, S24.4.3.1, S26.2.3, S26.3.1)

X 2.3 Measure the vertical distance from the top most point of the head restraint to the bottom most point. Locate and **mark** a horizontal plane through the midpoint of this distance. (S16.3.4.3)

Vertical height of head restraint: 220 mm

Mid-point height: 110 mm

X 3. Place the SCRIP in the full rearward, mid-height position, and mid-seat cushion angle. (S16.3.3.1.1)

X 4. Fully recline the seat back. (S16.3.3.1.2)

   N/A seat back not adjustable.

X 5. Place the dummy in the seat with the legs at an angle of 120 degrees to the thighs. The calves should not be touching the seat cushion. (S16.3.3.1.2)

X 6. Position the dummy in the seat such that the midsagittal plane is coincident with the longitudinal seat cushion marking that was determined in item 1.19 or 1.20. (S16.3.3.1.3 and S16.3.3.1.4)

X 7. Hold down the dummy's thighs and push rearward on the upper torso to maximize the pelvic angle. (S16.3.3.1.5)

X 8. Set the angle between the legs and the thighs to 120 degrees. (S16.3.3.1.6)

- X 9. Set the transverse distance between the centers of the front of the knees at 160 to 170 mm. (6.3 to 6.7 inches). Center the knee separation with respect to the longitudinal seat cushion marking that was determined in item 1.19 or 1.20. (S16.3.3.1.6)  
Record Knee Separation: 165 mm
- X 10. Push rearward on the dummy's knees until the pelvis contacts the seat back, or the backs of the calves contact the seat cushion, whichever occurs first. (S16.3.3.1.6)  
X Pelvis contacted seat back.  
\_\_\_ Calves contacted seat cushion.
- X 11. Gently rock the upper torso  $\pm 5$  degrees (approximately 51 mm (2 inches)) side-to-side three times. (S16.3.3.1.7)
- X 12. If needed, extend the legs until the feet do not contact the floor pan. The thighs should be resting on the seat cushion. (S16.3.3.1.8)
- X 13. Use seat controls to line up the seat markings determined during the completion of item 1 to set the foremost fore-aft position, mid-height position and the seat cushion mid-angle. If the dummy contacts the interior move the seat rearward until a maximum clearance of 5 mm (0.2 inches) is achieved or the seat is in the closest detent position that does not cause dummy contact. (S16.3.3.1.8)  
X Foremost, mid-height position and the seat cushion mid-angle reached  
\_\_\_ Dummy contact. Clearance set at maximum of 5 mm  
Measured Clearance: \_\_\_\_\_  
\_\_\_ Dummy Contact. Seat set at nearest detent position.  
Seat position \_\_\_ detent positions rearward of foremost  
(foremost is position zero)
- X 14. If the seat back is adjustable, rotate the seat back forward while holding the thighs in place. Continue rotating the seat back forward until the transverse instrument platform of the dummy head is level  $\pm 0.5$  degrees. If head cannot be leveled using the seat back adjustment, or the seat back is not adjustable, use the lower neck bracket adjustment to level the head. If a level position cannot be achieved, adjust the head as closely as possible to the  $\pm 0.5$  degree range. (S16.3.3.1.9 and S16.3.3.1.10)  
(Check All That Apply)  
\_\_\_ Seat back not adjustable  
\_\_\_ Seat back not independent of driver side seat back  
X Head Level Achieved. (Check all that apply)  
X Head leveled using the adjustable seat back  
\_\_\_ Head leveled using the neck bracket.  
Head Angle: 0.2 degrees  
\_\_\_ Head Level NOT Achieved. (Check all that apply)  
\_\_\_ Head adjusted using the adjustable seat back  
\_\_\_ Head adjusted using the neck bracket.  
Head Angle: \_\_\_\_\_ degrees
- X 15. Verify the pelvis is not interfering with the seat bight. (S16.3.3.1.9)  
X No interference  
\_\_\_ Pelvis moved forward the minimum amount so that it is not caught in the seat bight.
- X 16. Verify the dummy abdomen is properly installed. (S16.3.3.1.9)  
X Abdomen still seated properly into dummy  
\_\_\_ Abdomen was adjusted because it was not seated properly into dummy
- X 17. Head Angle  
X N/A, neither the pelvis nor the abdomen were adjusted.

17.1 Head still level (Go to 18)

17.2 Head level adjusted

Head Level Achieved. (Check all that apply)

Head leveled using the adjustable seat back

Head leveled using the neck bracket.

Head Angle: \_\_\_\_\_ degrees

Head Level NOT Achieved. (Check all that apply)

Head adjusted using the adjustable seat back

Head adjusted using the neck bracket.

Head Angle: \_\_\_\_\_ degrees

18. Measure and set the pelvic angle using the pelvic angle gage TE-2504. The pelvic angle should be 20.0 degrees  $\pm$  2.5 degrees. If the pelvic angle cannot be set to the specified range because the head will not be level or because the dummy will have need major repositioning, adjust the pelvis as closely as possible to the angle range, but keep the head level.

Pelvic angle set to 20.0 degrees  $\pm$  2.5 degrees.

Pelvic angle of 20.0 degrees not achieved, the angular difference was minimized.

Record the pelvic angle: 20.2 degrees

19. Check the dummy for contact with the interior after completing adjustments.

No contact.

Dummy in contact with interior.

Seat moved aft \_\_\_\_\_ mm from the previous position.

Seat moved aft \_\_\_\_\_ detent positions from the previous position.

20. Verify the transverse instrument platform of the dummy head is level +/- 0.5 degrees. Use the lower neck bracket adjustment to level the head. If a level position cannot be achieved, minimize the angle. (S16.3.3.1.9, S16.3.3.1.10, and S16.3.3.1.11)

Head Level Achieved

Head Angle: 0.2 degrees

Head Level NOT Achieved.

Head Angle: \_\_\_\_\_ degrees

21. Check the dummy to see if additional interior clearance is obtained, allowing the seat to be moved forward. (S16.3.3.1.12)

N/A Bench Seat

N/A Seat already at full forward position.

Clearance unchanged. No adjustments required.

Additional clearance available

Seat moved Forward \_\_\_\_\_ mm from the previous position.

Seat moved Forward \_\_\_\_\_ detent positions from the previous position.

Seat moved Forward, Full Forward position reached.

22. Passenger foot positioning. (Indicate final position achieved) (S16.3.3.2)

22.1 Place feet flat on the toe board; OR (S16.3.3.2.1)

22.2 If the feet cannot be placed flat on the toe board, set the feet perpendicular to the lower leg, and rest the heel as far forward on the floor pan as possible; OR (S16.3.3.2.2)

22.3 If the heels do not touch the floor pan, set the legs as perpendicular to the thighs as possible and set the feet parallel to the floor pan. (S16.3.3.2.2)

23. Passenger arm/hand positioning. (S16.3.3.3)

23.1 Place the dummy's upper arms adjacent to the torso with the arm centerlines as close to a vertical longitudinal plane as possible. (S16.3.3.3.1)

23.2 Place the palms of the dummy in contact with the outer part of the thighs (S16.3.3.3.2)

23.3 Place the little fingers in contact with the seat cushion. (S16.3.3.3.3)

24. Adjustable head restraints (S16.3.4)

N/A, there is no head restraint adjustment

24.1 If the head restraint has an automatic adjustment, leave it where the system positions the restraint after the dummy is placed in the seat. (S16.3.4.1) Go to 25.

24.2 Adjust each head restraint vertically so that the horizontal plane determined in Item 2 is aligned with the center of gravity (CG) of the dummy head. (S16.3.4.3)

24.3 If the above position is not attainable, move the vertical center of the head restraint to the closest detent below the center of the head CG. (S16.3.4.3)

N/A midpoint position attained in previous step

Headrest set at nearest detent below the head CG

24.4 If the head restraint has a fore and aft adjustment, place the restraint in the foremost position or until contact with the head is made, whichever occurs first. (S16.3.4.4)

25. Manual belt adjustment (for tests conducted with a belted dummy) (S16.3.5)

N/A, Unbelted test

25.1 If an adjustable seat belt D-ring anchorage exists, place it in the manufacturer's design position for a 5th percentile adult female. **This information will be supplied by the COTR.** (S16.3.5.1)

Manufacturer's specified position: 0 of 4; Upper-most defined as 0

Actual Position: 0 of 4; Upper-most defined as 0

25.2 Place the Type 2 manual belt around the test dummy and fasten the latch. (S16.3.5.2)

25.3 Ensure that the dummy's head remains as level as possible. (S16.3.5.3)

25.4 Remove all slack from the lap belt. Pull the upper torso webbing out of the retractor and allow it to retract; repeat this operation four times. Apply a 9 N (2 lbf) to 18 N (4 lbf) tension load to the lap belt. If the belt system is equipped with a tension-relieving device, introduce the maximum amount of slack into the upper torso belt that is recommended by the manufacturer. If the belt system is not equipped with a tension-relieving device, allow the excess webbing in the shoulder belt to be retracted by the retractive force of the retractor. (S16.3.5.4)

I certify that I have read and performed each instruction.

Signature: Keegan Stricker

Date: 9/19/23

# DATA SHEET 37

## DUMMY MEASUREMENTS

Test Vehicle: 2023 Volvo XC40  
 Test Program: FMVSS 208 Compliance  
 Test Technician: Keegan Strockis

NHTSA No.: C20235900  
 Test Date: 9/19/23

### DUMMY MEASUREMENTS FOR FRONT SEAT OCCUPANTS

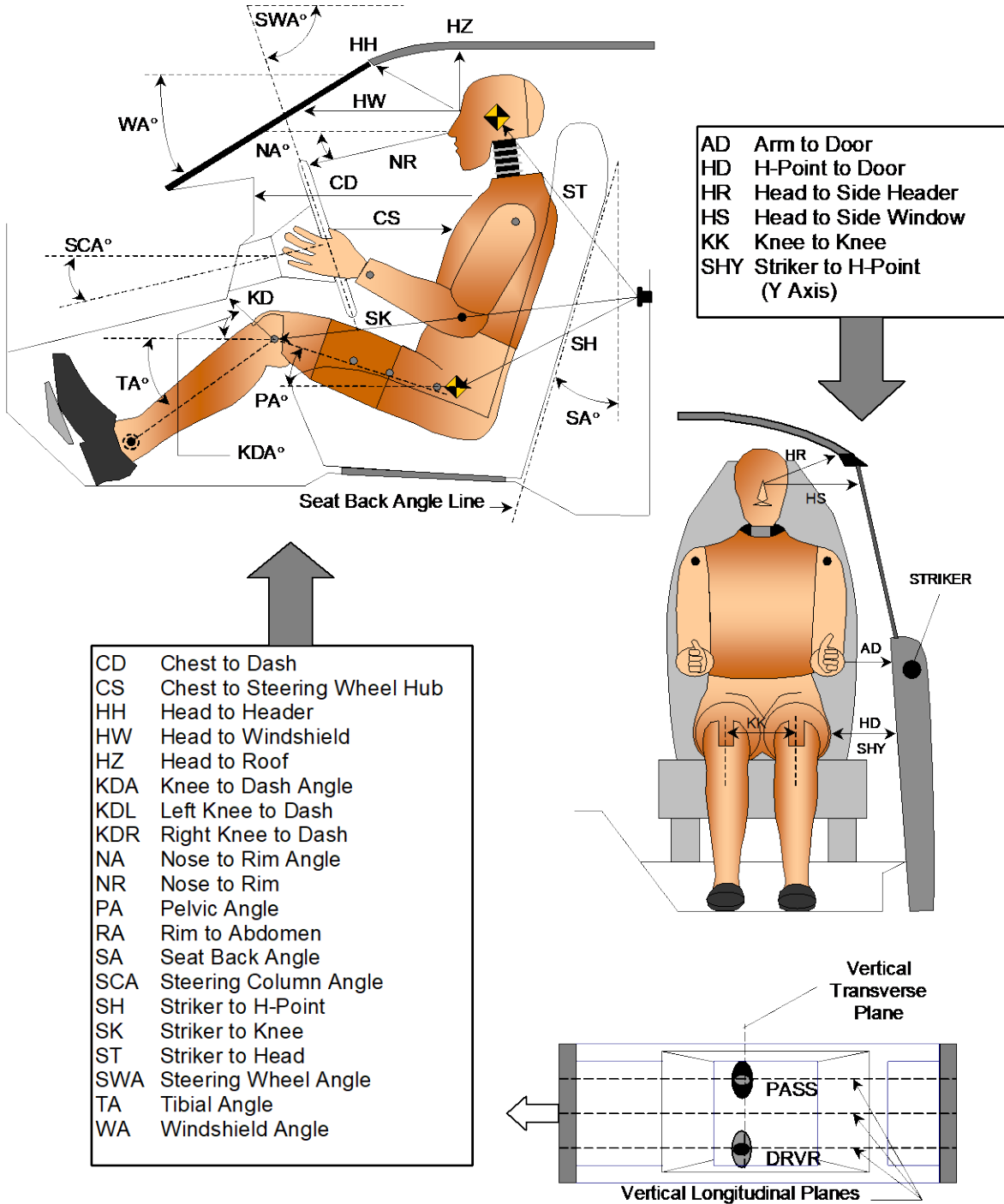

**TEST DUMMY POSITION MEASUREMENTS**

Code	Measurement Description	Driver SN 507		Passenger SN 510	
		Length (mm)	Angle (°)	Length (mm)	Angle (°)
WA	Windshield Angle		27.5		
SWA	Steering Wheel Angle		65.5		
SCA	Steering Column Angle		24.5		
SA	Seat Back Angle (On Headrest Post)		-3.3		-1.2
HZ	Head to Roof (Z)	187		186	
HH	Head to Header	272	48.3	265	52.8
HW	Head to Windshield	593	0.0	572	0.0
HR	Head to Side Header (Y)	236		230	
NR	Nose to Rim	280	8.1		
CD	Chest to Dash	436		333	
CS	Chest to Steering Hub	210	5.9		
RA	Rim to Abdomen	108	0.0		
KDL	Left Knee to Dash	122	31.2	74	
KDR	Right Knee to Dash	111		77	32.9
PA	Pelvic Angle		21.3		20.2
TA	Tibia Angle		73.5		64.4
KK	Knee to Knee (Y)	302		230	
SK	Striker to Knee	649	95.4	693	96.1
ST	Striker to Head	505	22.4	519	24.7
SH	Striker to H-Point	351	100.6	400	103.3
SHY	Striker to H-Point (Y)	316		320	
HS	Head to Side Window	395		365	
HD	H-Point to Door (Y)	248		141	
AD	Arm to Door (Y)	186		85	
AA	Ankle to Ankle	289		164	

# SEAT BELT POSITIONING DATA

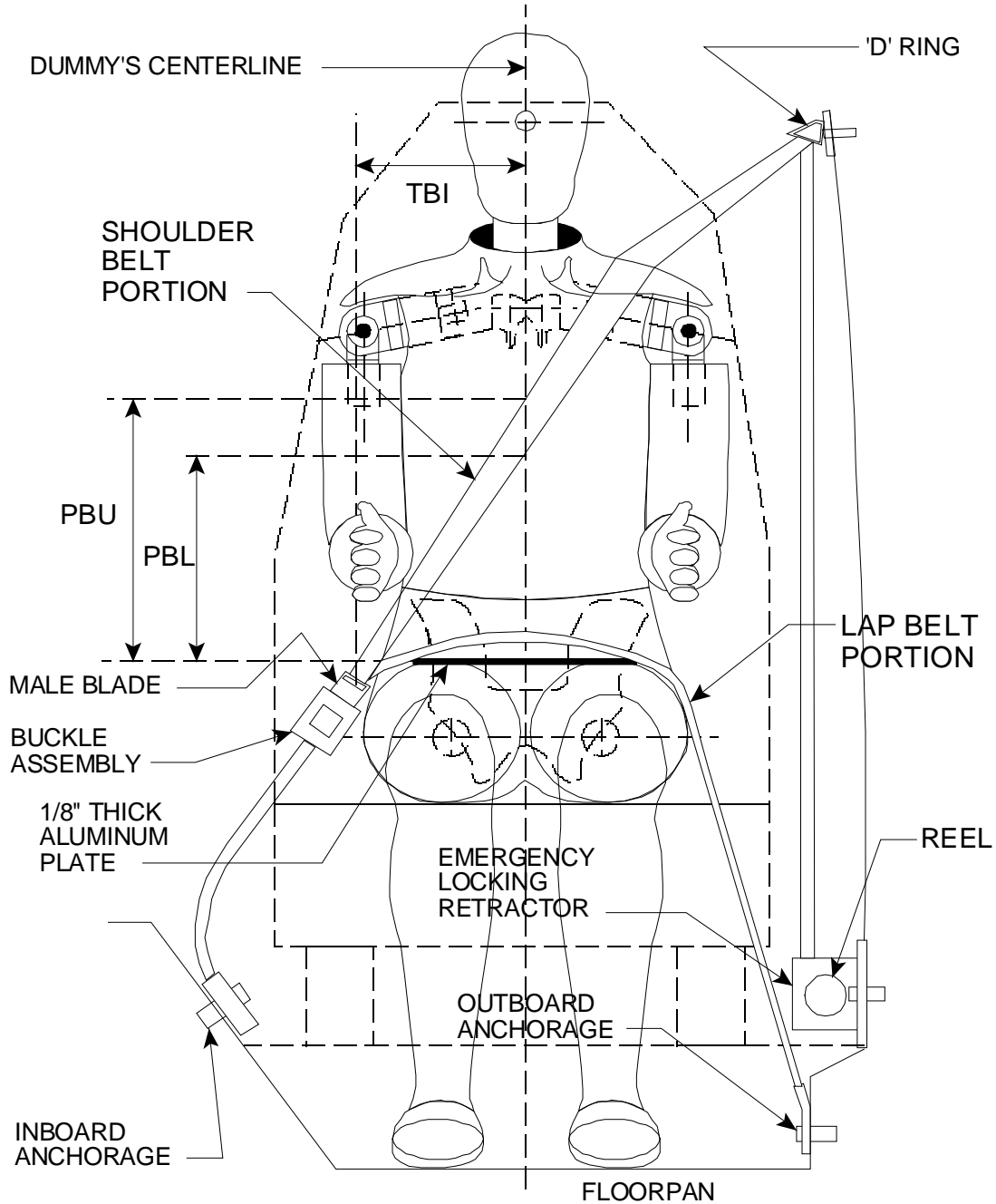

**FRONT VIEW OF DUMMY**

## SEAT BELT POSITIONING MEASUREMENTS

Measurement Description	Units	Driver	Passenger
PBU - Top surface of reference to belt upper edge	mm	290	320
PBL - Top surface of reference to belt lower edge	mm	200	230

## DATA SHEET 38

### CRASH TEST

Test Vehicle: 2023 Volvo XC40  
 Test Program: FMVSS 208 Compliance  
 Test Technician: Chad Williams

NHTSA No.: C20235900  
 Test Date: 9/19/23

IMPACT ANGLE:	0°			
BELTED DUMMIES (YES/NO):	YES			
TEST SPEED:	<input type="checkbox"/> 32 to 56 kmph	<input type="checkbox"/> 0 to 48 kmph	<input checked="" type="checkbox"/> 0 to 56 kmph	
DRIVER DUMMY:	<input checked="" type="checkbox"/> X	5 <sup>th</sup> female		50 <sup>th</sup> male
PASSENGER DUMMY:	<input checked="" type="checkbox"/> X	5 <sup>th</sup> female		50 <sup>th</sup> male

- 1. Vehicle underbody painted.
- 2. The speed measuring devices are in place and functioning.
- 3. The speed measuring devices are 1.0 m from the barrier (spec. 1.5 m) and 30 cm from the barrier (spec. is 30 cm).
- 4. Convertible top is in the closed position.  
 N/A, not a convertible.
- 5. Instrumentation and wires are placed so motion of dummies during impact is not affected.
- 6. Tires inflated to pressure on tire placard or if it does not have a tire placard because it is not a passenger car, then inflated to the tire pressure specified in the owner information.  
  
230 kpa front left tire 230 kpa specified on tire placard or in owner information  
230 kpa front right tire 230 kpa specified on tire placard or in owner information  
230 kpa rear left tire 230 kpa specified on tire placard or in owner information  
230 kpa rear right tire 230 kpa specified on tire placard or in owner information
- 7. Time zero contacts on barrier in place.
- 8. Pre test zero and shunt calibration adjustments performed and recorded.
- 9. Dummy temperature meets requirements of section 12.2 of the test procedure.
- 10. Vehicle hood closed and latched.
- 11. Transmission placed in neutral.
- 12. Parking brake off.
- 13. Are the heads still level?  
 Yes, go to 14  
 No, Adjust dummy so that head is at the angle recorded in the Appendix F or G data sheets and then continue.
- 14. Ignition in the ON position.
- 15. Doors closed and latched but not locked.
- 16. Post test zero and shunt calibration checks performed and recorded.
- 17. Actual test speed: 55.3 kmph
- 18. Vehicle rebound from the barrier: 60 cm
- 19. Describe whether the doors open after the test and what method is used to open the doors.  
 Left Front Door: Door remained closed and latched; Door opened without tools.  
 Right Front Door: Door remained closed and latched; Door opened without tools.  
 Left Rear Door: Door remained closed and latched; Door opened without tools.  
 Right Rear Door: Door remained closed and latched; Door opened without tools.

20. Describe the contact points of the dummy with the interior of the vehicle.
- Driver Dummy: Head to Air Bag and Headrest; Chest to Air Bag; Knees to Knee Air Bag
  - Passenger Dummy: Head to Air Bag and Headrest; Chest to Air Bag; Knees to Glovebox

REMARKS:

Signature: Chad Willis

Date: 9/19/23

I certify that I have read and performed each instruction.

**DATA SHEET 40**  
**ACCIDENT INVESTIGATION MEASUREMENTS**

Test Vehicle: 2023 Volvo XC40  
 Test Program: FMVSS 208 Compliance  
 Test Technician: Chad Williams

NHTSA No.: C20235900  
 Test Date: 9/19/23

IMPACT ANGLE:	0°					
BELTED DUMMIES (YES/NO):	YES					
TEST SPEED:	<input type="checkbox"/>	32 to 56 kmph	<input type="checkbox"/>	0 to 48 kmph	<input checked="" type="checkbox"/>	0 to 56 kmph
DRIVER DUMMY:	<input checked="" type="checkbox"/>	X	5 <sup>th</sup> female	<input type="checkbox"/>	<input type="checkbox"/>	50 <sup>th</sup> male
PASSENGER DUMMY:	<input checked="" type="checkbox"/>	X	5 <sup>th</sup> female	<input type="checkbox"/>	<input type="checkbox"/>	50 <sup>th</sup> male

Vehicle Year/Make/Model/Body Style:	2023 Volvo XC40 MPV
VIN:	YV4K92HK4P2917194
Wheelbase:	2708 mm
Build Date:	06/22
Vehicle Size Category:	3
Test Weight:	1855.7 kg
Front Overhang:	836 mm
Overall Width:	1842 mm
Overall Length Center:	4440 mm

Accelerometer Data	
Location:	As per measurements on Data Sheet 33
Linearity:	>99.9%

Integration Algorithm:	Trapezoidal
Vehicle Impact Speed:	55.3 kmph
Time of Separation:	85.0 ms
Velocity Change:	64.9 kmph

## CRUSH PROFILE

Collision Deformation Classification: 12FDEW3  
 Midpoint of Damage: Vehicle Longitudinal Centerline  
 Damage Region Length (mm): 1310  
 Impact Mode: Frontal Barrier

No.	Measurement Description	Units	Pre-Test	Post-Test	Difference
C1	Crush zone 1 at left side	mm	4296	3910	386
C2	Crush zone 2 at left side	mm	4396	4000	396
C3	Crush zone 3 at left side	mm	4439	4015	424
C4	Crush zone 4 at right side	mm	4439	3992	447
C5	Crush zone 5 at right side	mm	4396	3948	448
C6	Crush zone 6 at right side	mm	4296	3962	334

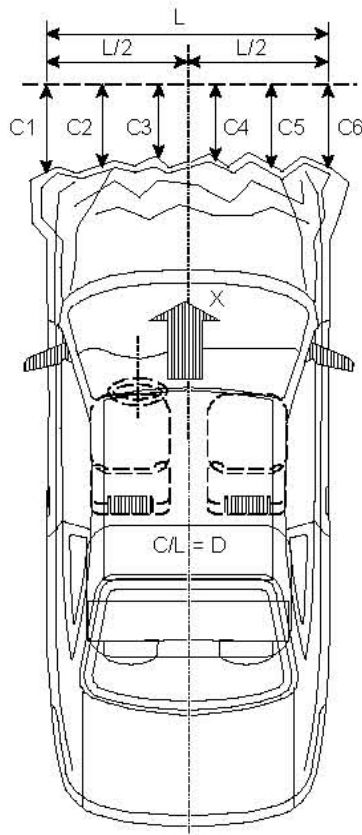

REMARKS:

Signature: Chad Wilkin

Date: 9/19/23

I certify that I have read and performed each instruction.

**DATA SHEET 41**  
**WINDSHIELD MOUNTING (FMVSS 212)**

Test Vehicle: 2023 Volvo XC40  
 Test Program: FMVSS 208 Compliance  
 Test Technician: Chad Williams

NHTSA No.: C20235900  
 Test Date: 9/19/23

IMPACT ANGLE:	0°			
BELTED DUMMIES (YES/NO):	YES			
TEST SPEED:	<input type="checkbox"/> 32 to 56 kmph	<input type="checkbox"/> 0 to 48 kmph	<input checked="" type="checkbox"/> 0 to 56 kmph	
DRIVER DUMMY:	<input checked="" type="checkbox"/> X	5 <sup>th</sup> female		50 <sup>th</sup> male
PASSENGER DUMMY:	<input checked="" type="checkbox"/> X	5 <sup>th</sup> female		50 <sup>th</sup> male

1. Pre-Crash
- 1.1 Describe from visual inspection how the windshield is mounted and describe any trim material.
- Retained with glue, rubber and plastic trim
- 1.2 Mark the longitudinal centerline of the windshield.
- 1.3 Measure pre-crash A, B, and C for the left side and record in the chart below.
- 1.4 Measure pre-crash C, D, and E for the right side and record in the chart below.
- 1.5 Measure from the edge of the retainer or molding to the edge of the windshield.
- Dimension G (mm): 5 mm
2. Post Crash
- 2.1 Can a single thickness of copier type paper (as small a piece as necessary) slide between the windshield and the vehicle body?
- No - Pass. Skip to the table of measurements, complete it by repeating the pre-crash measurements in the post crash column, and calculate the retention percentage, which will be 100%.
- Yes, go to 2.2
- 2.2 Visibly mark the beginning and end of the portions of the periphery where the paper slides between the windshield and the vehicle body.
- 2.3 Measure and record post-crash A, B, C, D, E, and F such that the measurements do not include any of the parts of the windshield where the paper slides between the windshield and the vehicle body.
- 2.4 Calculate and record the percent retention for the right and left side of the windshield.
- 2.5 Is total right side percent retention less than 50%?
- Yes, Fail
- No, Pass
- 2.6 Is total left side percent retention less than 50%?
- Yes, Fail
- No, Pass

### WINDSHIELD RETENTION MEASUREMENTS

	Dimension	Pre-Crash (mm)	Post-Crash (mm)	Percent Retention (Post-Test ÷ Pre-Crash)
Left Side	A	600	600	100%
	B	830	830	100%
	C	750	750	100%
	Total	2180	2180	100%
Right Side	D	600	600	100%
	E	830	830	100%
	F	750	750	100%
	Total	2180	2180	100%

Indicate area of mounting failure: NONE

### FRONT VIEW OF WINDSHIELD

INDICATE WIDTH OF MOLDING

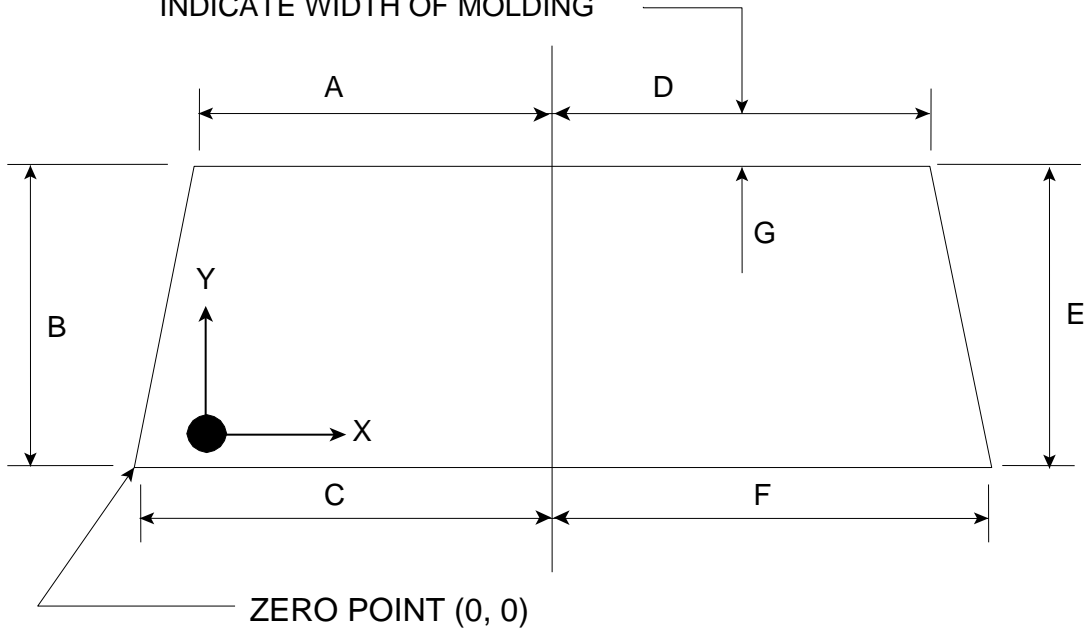

REMARKS: NONE

Signature: Clad Willis

Date: 9/19/23

I certify that I have read and performed each instruction.

**DATA SHEET 42**  
**WINDSHIELD ZONE INTRUSION (FMVSS 219)**

Test Vehicle: 2023 Volvo XC40  
 Test Program: FMVSS 208 Compliance  
 Test Technician: Chad Williams

NHTSA No.: C20235900  
 Test Date: 9/19/23

IMPACT ANGLE:	0°			
BELTED DUMMIES (YES/NO):	YES			
TEST SPEED:	<input type="checkbox"/> 32 to 56 kmph	<input type="checkbox"/> 0 to 48 kmph	<input checked="" type="checkbox"/> 0 to 56 kmph	
DRIVER DUMMY:	<input checked="" type="checkbox"/> X	5 <sup>th</sup> female		50 <sup>th</sup> male
PASSENGER DUMMY:	<input checked="" type="checkbox"/> X	5 <sup>th</sup> female		50 <sup>th</sup> male

This standard specifies limits for the displacement of vehicle components into the windshield area during a frontal barrier impact test at any speed up to and including 48 kmph.

- 1. Place a 165 mm diameter rigid sphere, with a mass of 6.8 kg on the instrument panel so that it is simultaneously touching the instrument panel and the windshield. (571.219 S6.1(a))
- 2. Roll the sphere from one side of the windshield to the other while marking on the windshield where the sphere contacts the windshield. (571.219 S6.1(b))
- 3. From the outermost contactable points on the windshield draw a horizontal line to the edges of the windshield. (571.219 S6.1(b))
- 4. Draw a line on the inner surface of the windshield that is 13 mm below the line determined in items 2 and 3.
- 5. After the crash test, record any points where a part of the exterior of the vehicle has marked, penetrated, or broken the windshield.

Provide all dimensions necessary to reproduce the protected area.

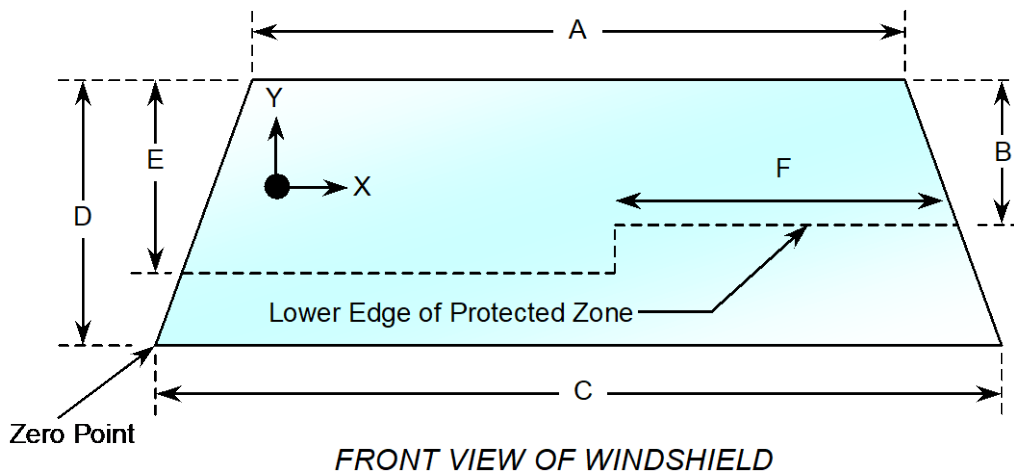

**WINDSHIELD DIMENSIONS**

Item	Units	Value
A	mm	1200
B	mm	460
C	mm	1500
D	mm	830
E	mm	510
F	mm	520

AREA OF PROTECTED ZONE FAILURES:

- B. Provide coordinates of the area that the protected zone was penetrated more than 0.25 inches by a vehicle component other than one which is normally in contact with the windshield.

X	Y
NONE	

- C. Provide coordinates of the area beneath the protected zone template that the inner surface of the windshield was penetrated by a vehicle component.

X	Y
NONE	

REMARKS:

I certify that I have read and performed each instruction.

Signature: Clad Wilkin

Date: 9/19/23

**DATA SHEET 43**  
**FUEL SYSTEM INTEGRITY (FMVSS 301)**

Test Vehicle: 2023 Volvo XC40  
Test Program: FMVSS 208 Compliance  
Test Technician: Chris Roach

NHTSA No.: C20235900  
Test Date: 9/19/23

TYPE OF IMPACT:	35 mph Belted
-----------------	---------------

**Stoddard Solvent Spillage Measurements**

- A. From impact until vehicle motion ceases: 0.0 grams  
(Maximum Allowable = 28 grams)
- B. For the 5 minute period after motion ceases: 0.0 grams  
(Maximum Allowable = 142 grams)
- C. For the following 25 minutes: 0.0 grams  
(Maximum Allowable = 28 grams/minute)
- D. Spillage: NONE

REMARKS: NO SPILLAGE

## FMVSS 301 STATIC ROLLOVER DATA

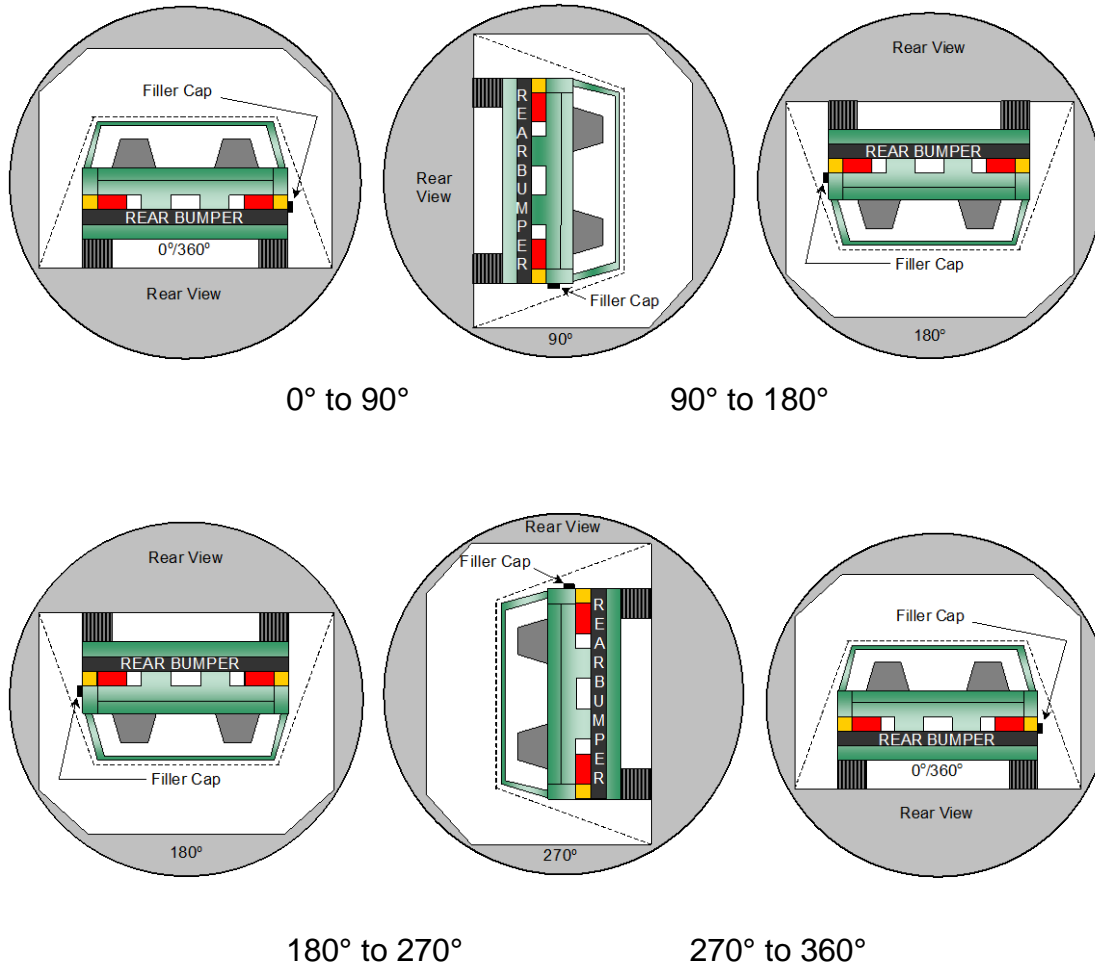

1. The specified fixture rollover rate for each 90° of rotation is 60 to 180 seconds.
2. The position hold time at each position is 300 seconds (minimum).
3. Details of Stoddard Solvent spillage locations: **None**

Test Phase	Rotation Time (sec.)	Hold Time (sec.)	Spillage (grams)
0° to 90°	120	305	0.0
90° to 180°	118	305	0.0
180° to 270°	118	305	0.0
270° to 360°	120	305	0.0

## APPENDIX A

### CRASH TEST DATA

#### TABLE OF DATA PLOTS

		<u>Page No.</u>
Figure No. 1.	Driver Head X Acceleration vs. Time	A-1
Figure No. 2.	Driver Head Y Acceleration vs. Time	A-1
Figure No. 3.	Driver Head Z Acceleration vs. Time	A-1
Figure No. 4.	Driver Head Resultant Acceleration vs. Time	A-1
Figure No. 5.	Driver Head X Velocity vs. Time	A-2
Figure No. 6.	Driver Head Y Velocity vs. Time	A-2
Figure No. 7.	Driver Head Z Velocity vs. Time	A-2
Figure No. 8.	Driver Neck Force X vs. Time	A-3
Figure No. 9.	Driver Neck Force Y vs. Time	A-3
Figure No. 10.	Driver Neck Force Z vs. Time	A-3
Figure No. 11.	Driver Neck Force Resultant vs. Time	A-3
Figure No. 12.	Driver Neck Moment X vs. Time	A-4
Figure No. 13.	Driver Neck Moment Y vs. Time	A-4
Figure No. 14.	Driver Neck Moment Z vs. Time	A-4
Figure No. 15.	Driver Neck Moment Resultant vs. Time	A-4
Figure No. 16.	Driver Chest X Acceleration vs. Time	A-5
Figure No. 17.	Driver Chest Y Acceleration vs. Time	A-5
Figure No. 18.	Driver Chest Z Acceleration vs. Time	A-5
Figure No. 19.	Driver Chest Resultant Acceleration vs. Time	A-5
Figure No. 20.	Driver Chest X Velocity vs. Time	A-6
Figure No. 21.	Driver Chest Y Velocity vs. Time	A-6
Figure No. 22.	Driver Chest Z Velocity vs. Time	A-6
Figure No. 23.	Driver Chest Displacement vs. Time	A-6
Figure No. 24.	Driver Left Femur Force vs. Time	A-7
Figure No. 25.	Driver Right Femur Force vs. Time	A-7
Figure No. 26.	Passenger Head X Acceleration vs. Time	A-8
Figure No. 27.	Passenger Head Y Acceleration vs. Time	A-8
Figure No. 28.	Passenger Head Z Acceleration vs. Time	A-8
Figure No. 29.	Passenger Head Resultant Acceleration vs. Time	A-8
Figure No. 30.	Passenger Head X Velocity vs. Time	A-9

	<u>Page No.</u>	
Figure No. 31.	Passenger Head Y Velocity vs. Time	A-9
Figure No. 32.	Passenger Head Z Velocity vs. Time	A-9
Figure No. 33.	Passenger Neck Force X vs. Time	A-10
Figure No. 34.	Passenger Neck Force Y vs. Time	A-10
Figure No. 35.	Passenger Neck Force Z vs. Time	A-10
Figure No. 36.	Passenger Neck Force Resultant vs. Time	A-10
Figure No. 37.	Passenger Neck Moment X vs. Time	A-11
Figure No. 38.	Passenger Neck Moment Y vs. Time	A-11
Figure No. 39.	Passenger Neck Moment Z vs. Time	A-11
Figure No. 40.	Passenger Neck Moment Resultant vs. Time	A-11
Figure No. 41.	Passenger Chest X Acceleration vs. Time	A-12
Figure No. 42.	Passenger Chest Y Acceleration vs. Time	A-12
Figure No. 43.	Passenger Chest Z Acceleration vs. Time	A-12
Figure No. 44.	Passenger Chest Resultant Acceleration vs. Time	A-12
Figure No. 45.	Passenger Chest X Velocity vs. Time	A-13
Figure No. 46.	Passenger Chest Y Velocity vs. Time	A-13
Figure No. 47.	Passenger Chest Z Velocity vs. Time	A-13
Figure No. 48.	Passenger Chest Displacement vs. Time	A-13
Figure No. 49.	Passenger Left Femur Force vs. Time	A-14
Figure No. 50.	Passenger Right Femur Force vs. Time	A-14
Figure No. 51.	Driver Nij ( $N_{TF}$ ) vs. Time	A-15
Figure No. 52.	Driver Nij ( $N_{TE}$ ) vs. Time	A-15
Figure No. 53.	Driver Nij ( $N_{CF}$ ) vs. Time	A-15
Figure No. 54.	Driver Nij ( $N_{CE}$ ) vs. Time	A-15
Figure No. 55.	Passenger Nij ( $N_{TF}$ ) vs. Time	A-16
Figure No. 56.	Passenger Nij ( $N_{TE}$ ) vs. Time	A-16
Figure No. 57.	Passenger Nij ( $N_{CF}$ ) vs. Time	A-16
Figure No. 58.	Passenger Nij ( $N_{CE}$ ) vs. Time	A-16
Figure No. 59.	Driver Occipital Condyle Moment vs. Time	A-17
Figure No. 60.	Passenger Occipital Condyle Moment vs. Time	A-17
Figure No. 61.	Left Rear Seat Crossmember X Acceleration vs. Time	A-18
Figure No. 62.	Left Rear Seat Crossmember X Velocity vs. Time	A-18
Figure No. 63.	Right Rear Seat Crossmember X Acceleration vs. Time	A-18
Figure No. 64.	Right Rear Seat Crossmember X Velocity vs. Time	A-18
Figure No. 65.	Top of Engine X Acceleration vs. Time	A-19

		<u>Page No.</u>
Figure No. 66.	Top of Engine X Velocity vs. Time	A-19
Figure No. 67.	Bottom of Engine X Acceleration vs. Time	A-19
Figure No. 68.	Bottom of Engine X Velocity vs. Time	A-19
Figure No. 69.	Left Brake Caliper X Acceleration vs. Time	A-20
Figure No. 70.	Left Brake Caliper X Velocity vs. Time	A-20
Figure No. 71.	Right Brake Caliper X Acceleration vs. Time	A-20
Figure No. 72.	Right Brake Caliper X Velocity vs. Time	A-20
Figure No. 73.	Instrument Panel X Acceleration vs. Time	A-21
Figure No. 74.	Instrument Panel X Velocity vs. Time	A-21
Figure No. 75.	Trunk Z Acceleration vs. Time	A-21
Figure No. 76.	Trunk Z Velocity vs. Time	A-21

**DRIVER HEAD X (g) vs Time (ms)**

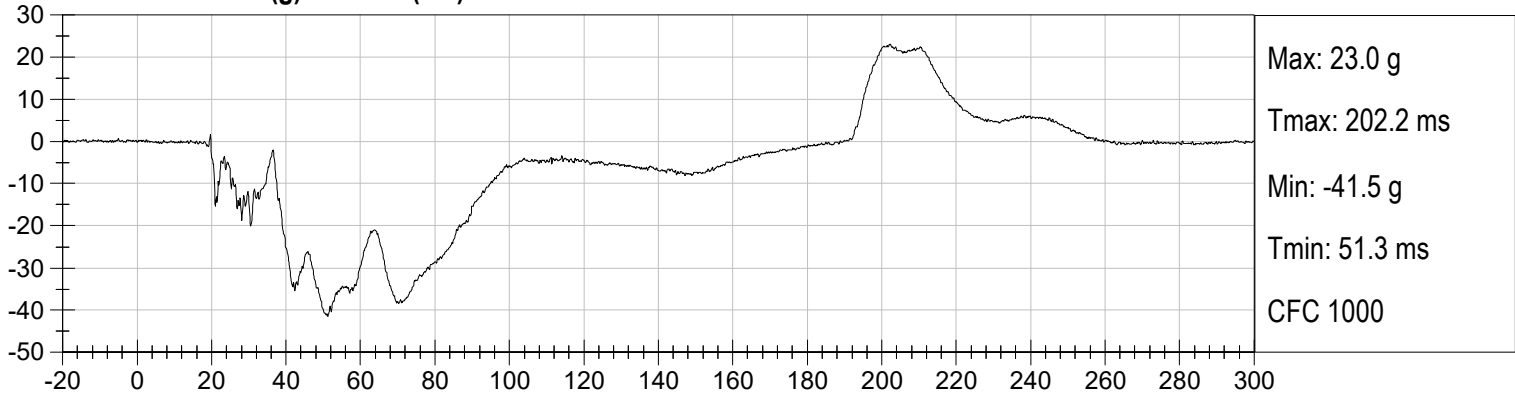

**DRIVER HEAD Y (g) vs Time (ms)**

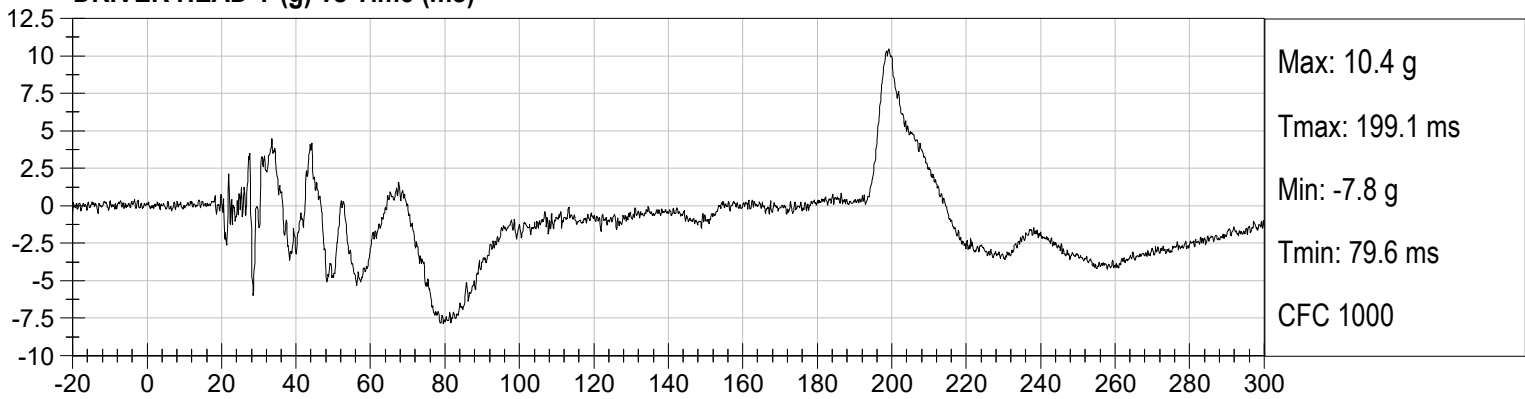

**DRIVER HEAD Z (g) vs Time (ms)**

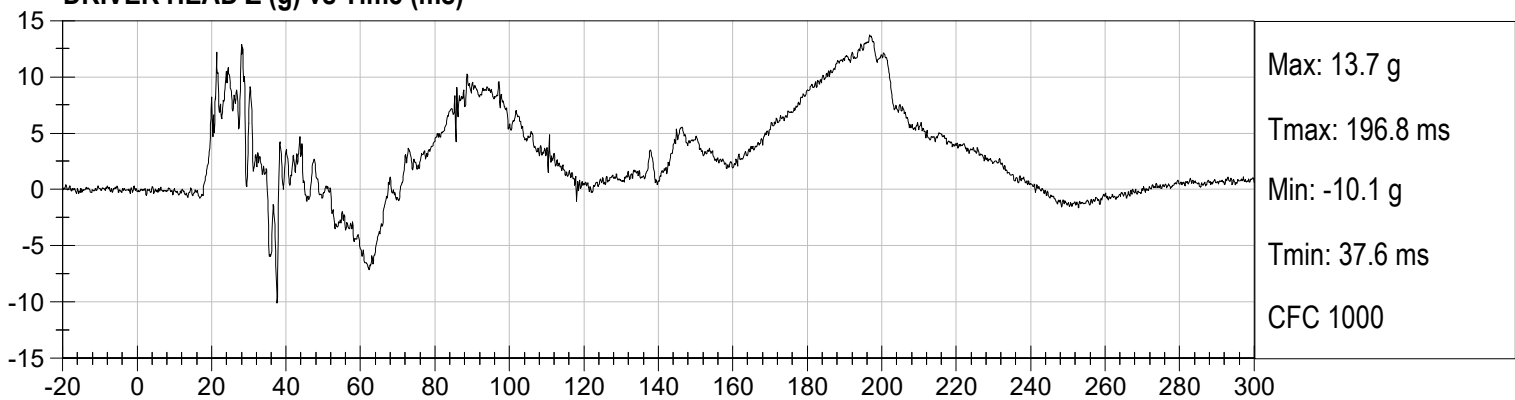

**DRIVER HEAD Resultant (g) vs Time (ms)**

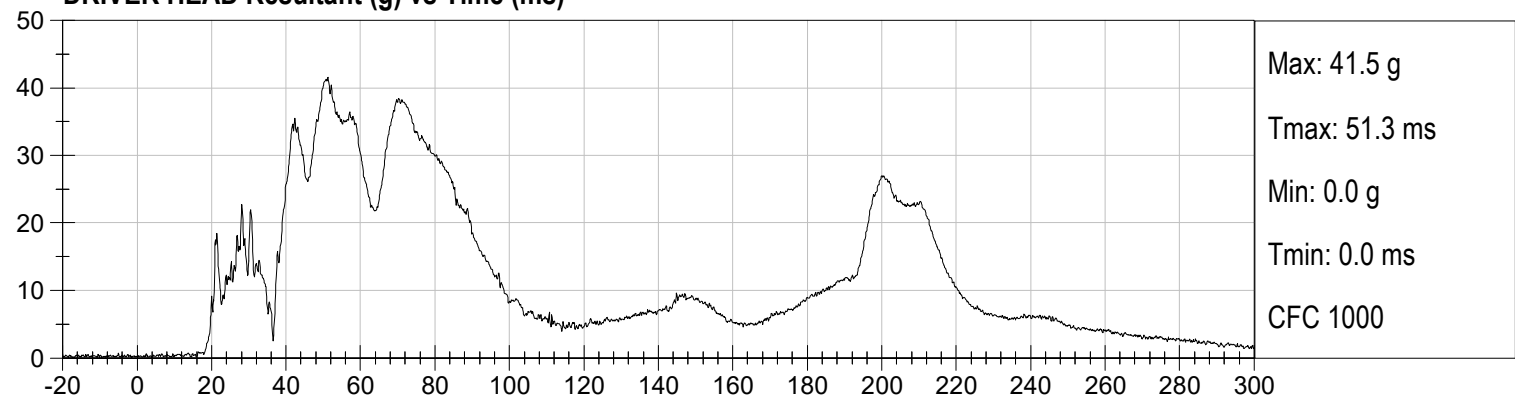

**DRIVER HEAD X Velocity (kph) vs Time (ms)**

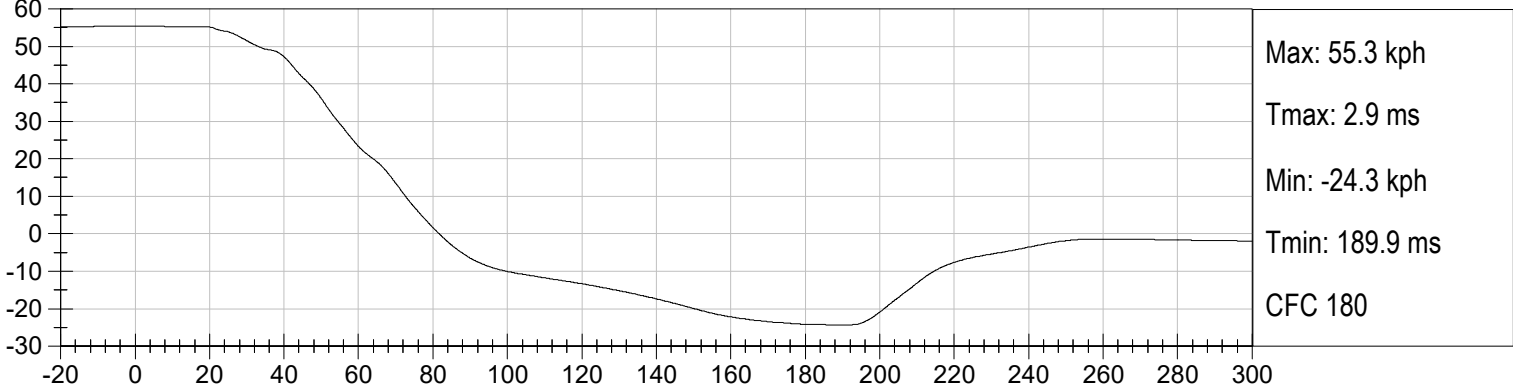

**DRIVER HEAD Y Velocity (kph) vs Time (ms)**

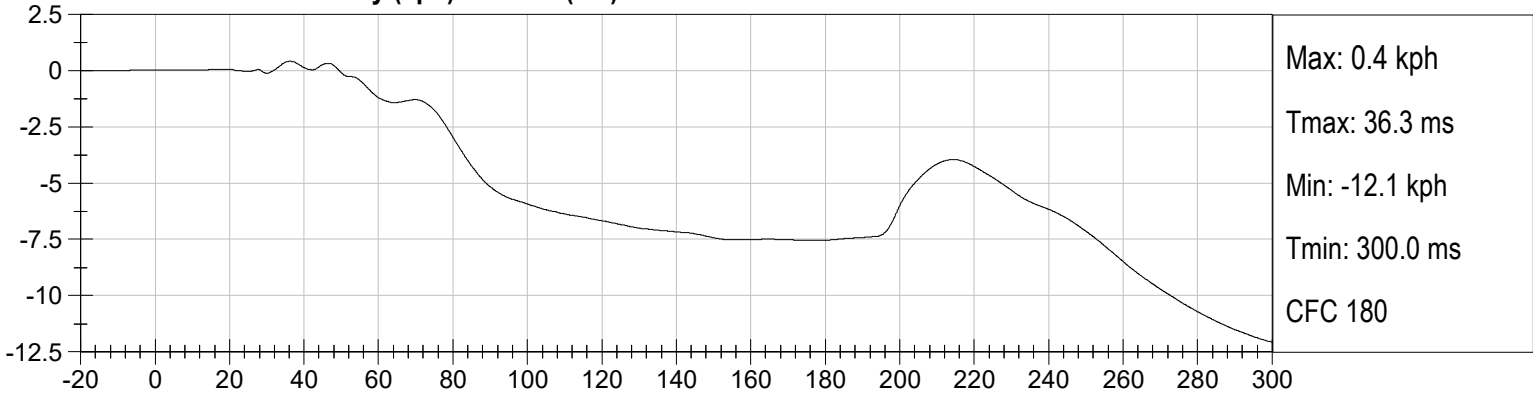

**DRIVER HEAD Z Velocity (kph) vs Time (ms)**

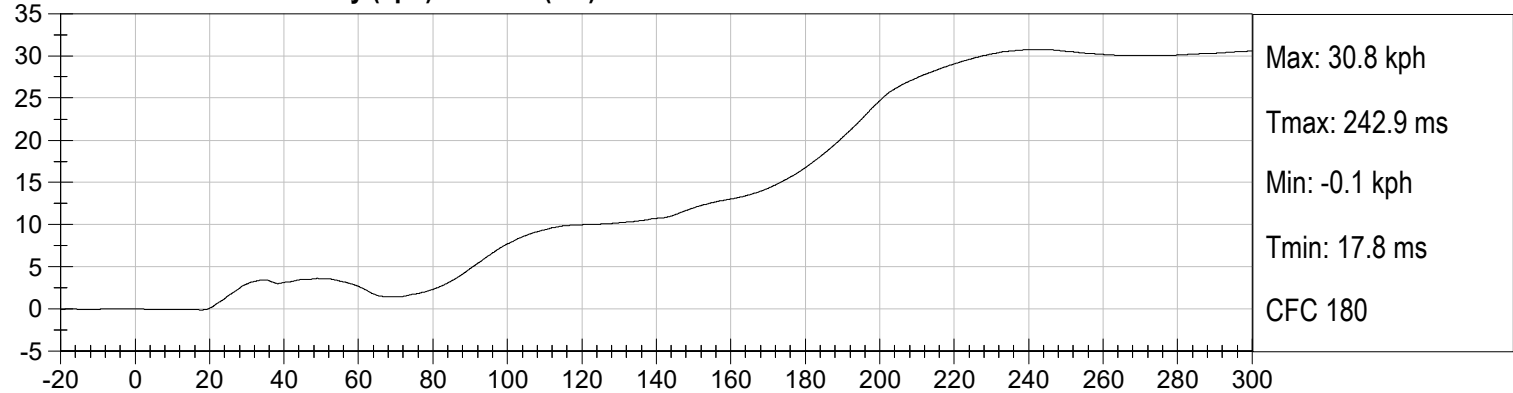

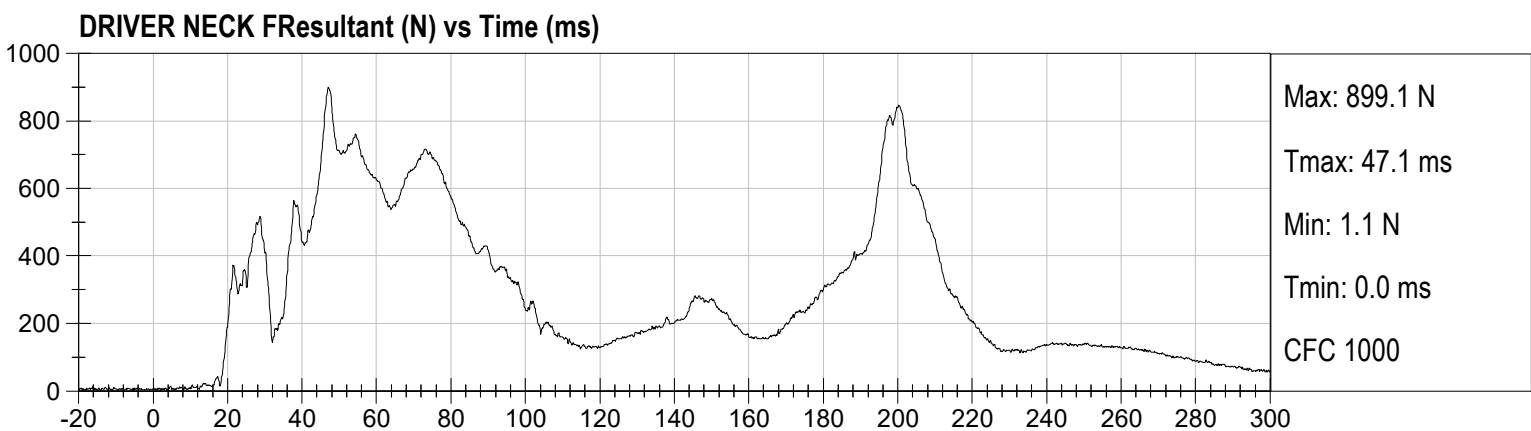
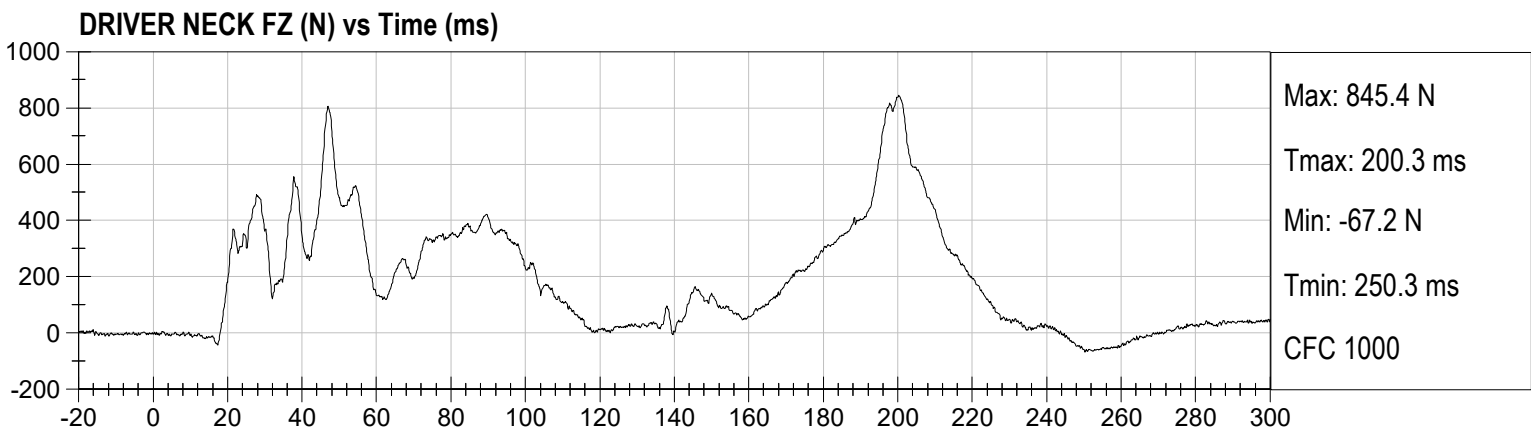
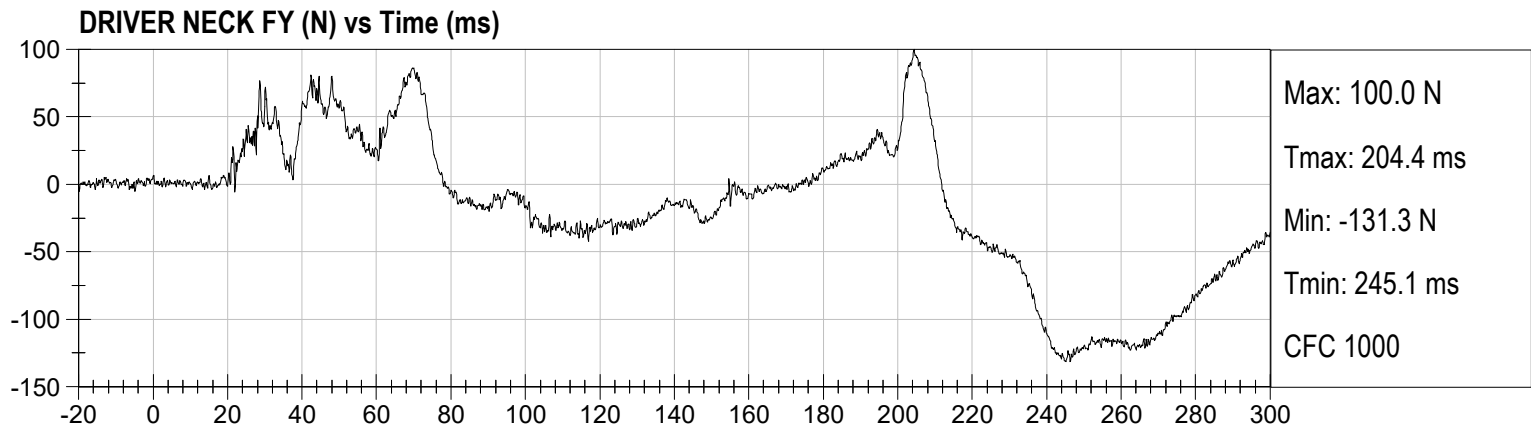
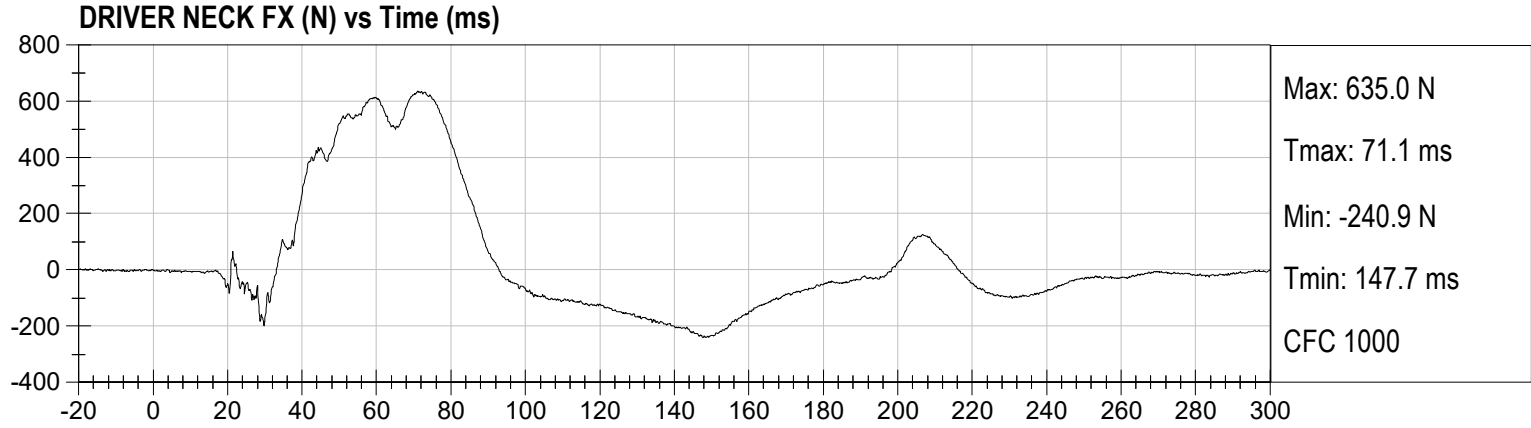

**DRIVER NECK MX (Nm) vs Time (ms)**

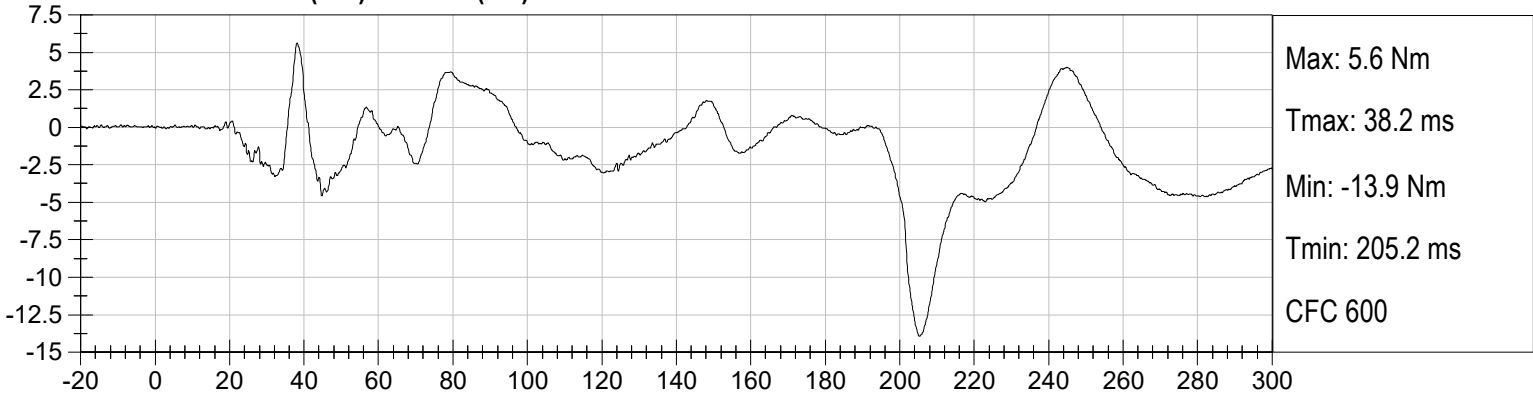

**DRIVER NECK MY (Nm) vs Time (ms)**

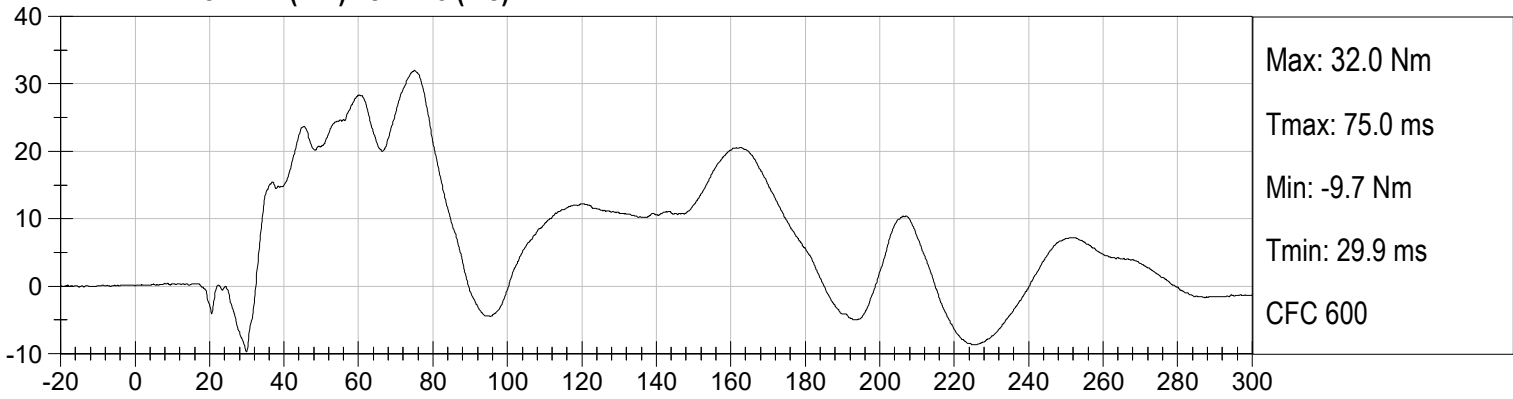

**DRIVER NECK MZ (Nm) vs Time (ms)**

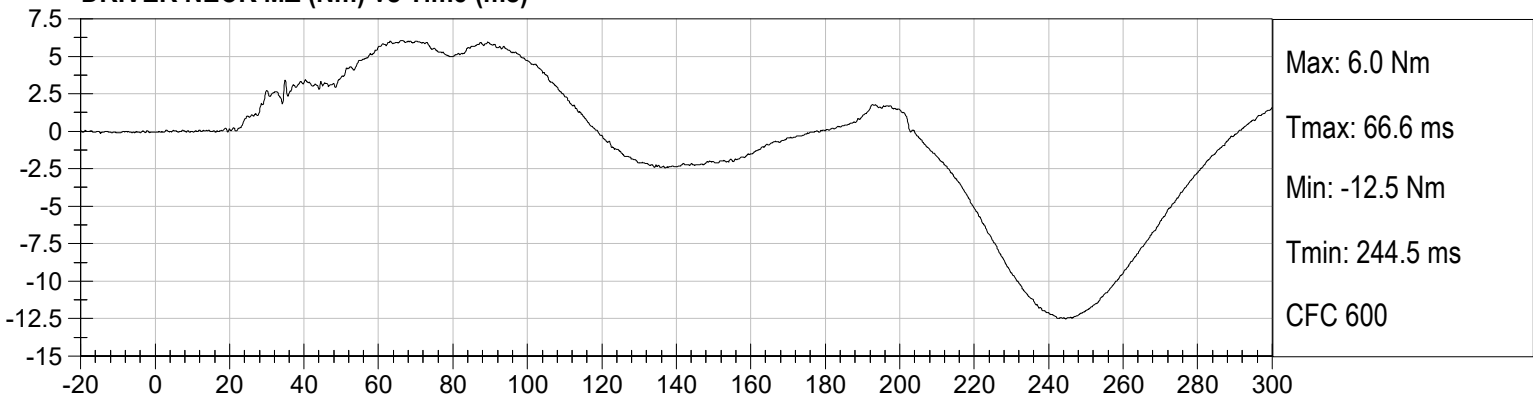

**DRIVER NECK MResultant (Nm) vs Time (ms)**

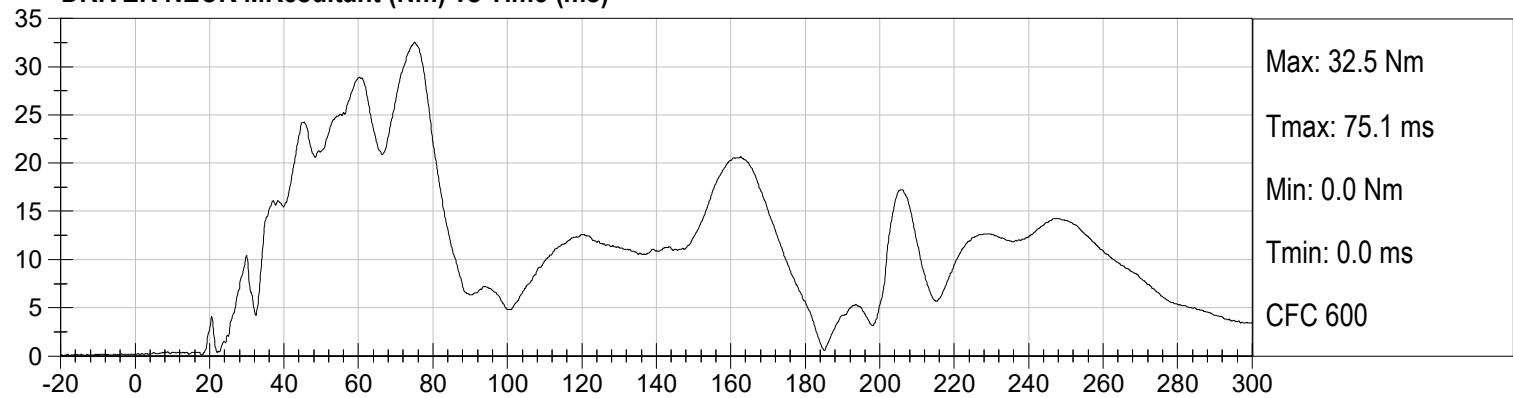

**DRIVER CHEST X (g) vs Time (ms)**

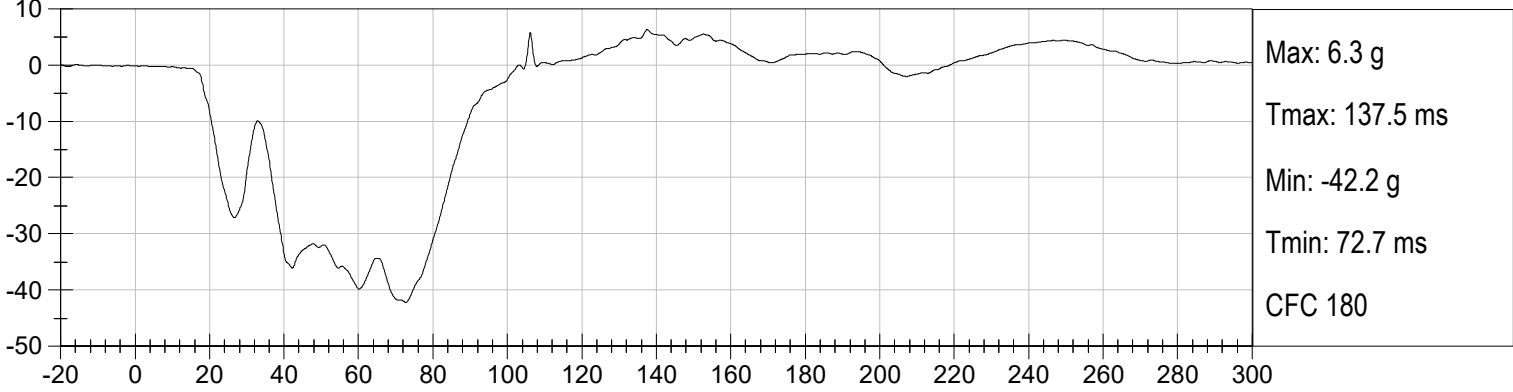

**DRIVER CHEST Y (g) vs Time (ms)**

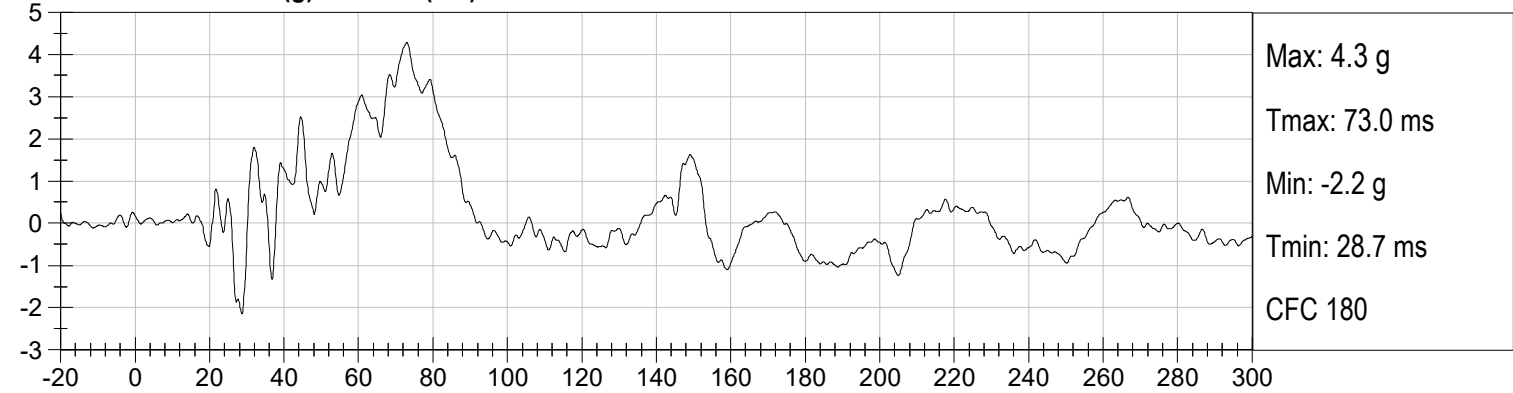

**DRIVER CHEST Z (g) vs Time (ms)**

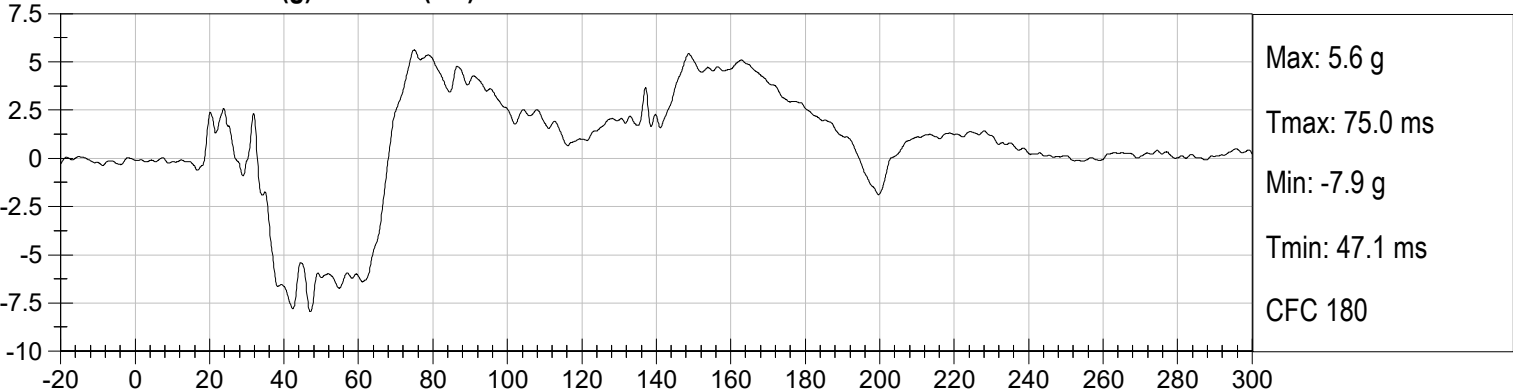

**DRIVER CHEST Resultant (g) vs Time (ms)**



**DRIVER CHEST X Velocity (kph) vs Time (ms)**

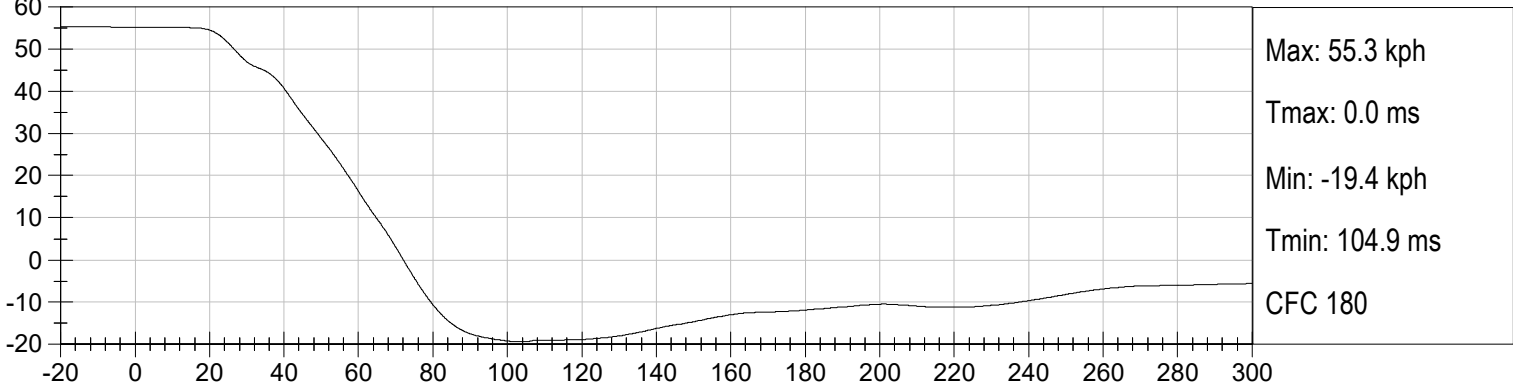

**DRIVER CHEST Y Velocity (kph) vs Time (ms)**

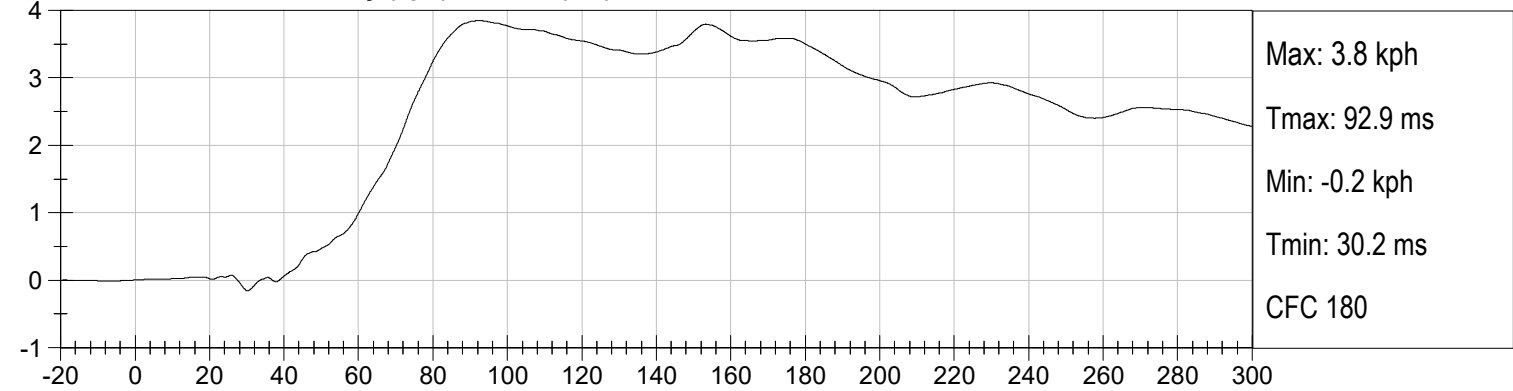

**DRIVER CHEST Z Velocity (kph) vs Time (ms)**

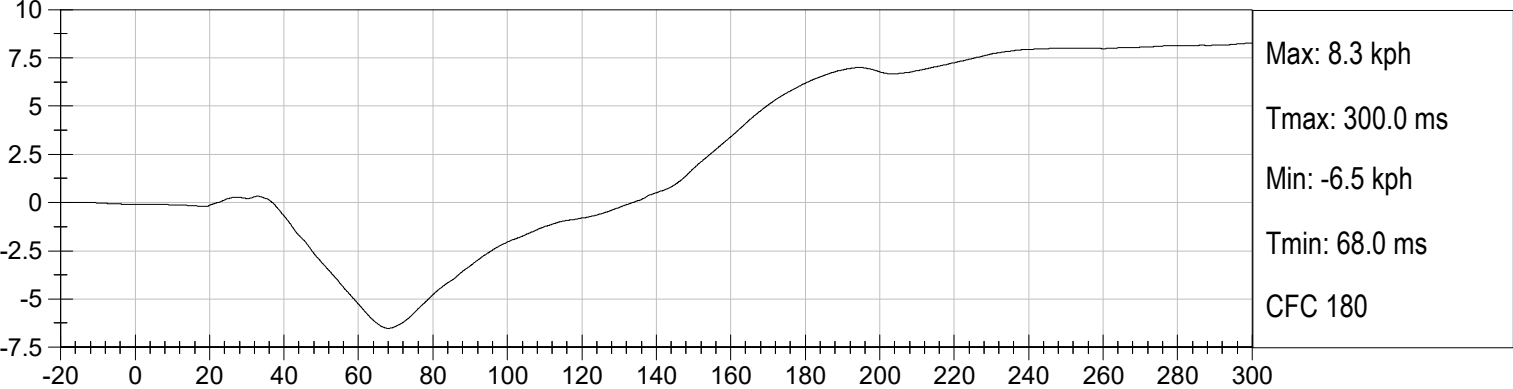

**DRIVER CHEST DISPLACEMENT (mm) vs Time (ms)**

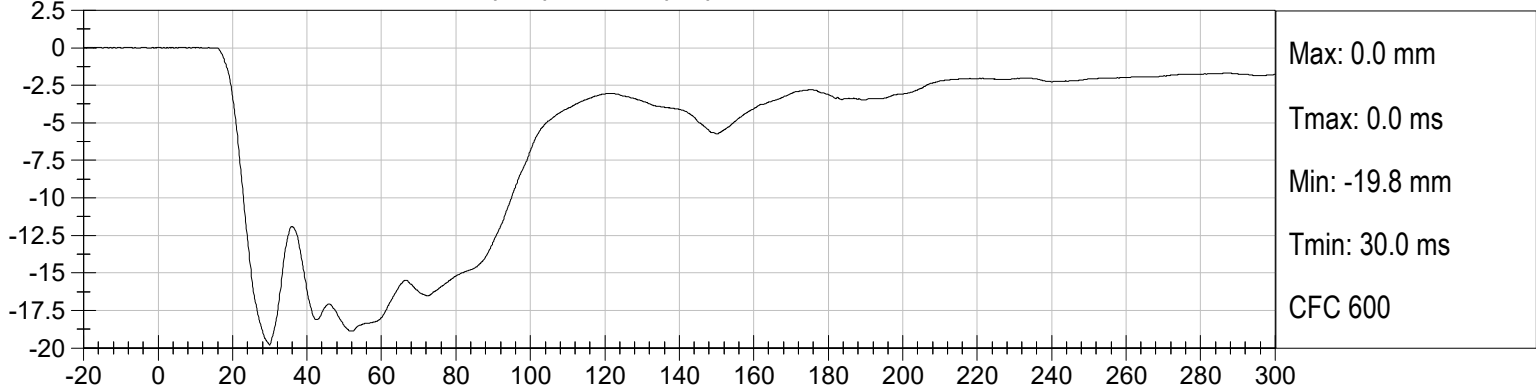

**DRIVER LEFT FEMUR (N) vs Time (ms)**

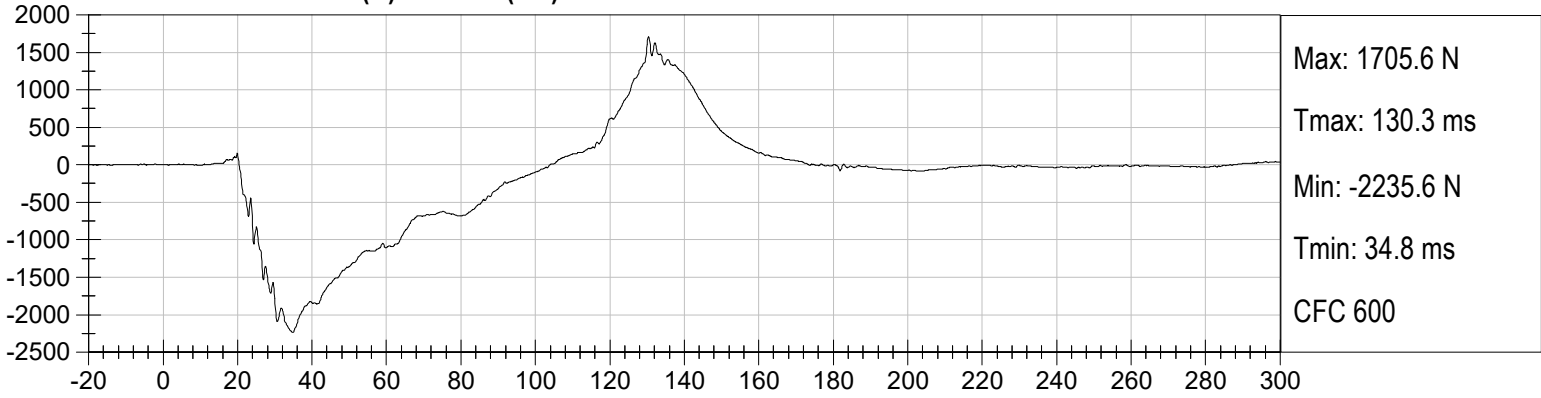

**DRIVER RIGHT FEMUR (N) vs Time (ms)**

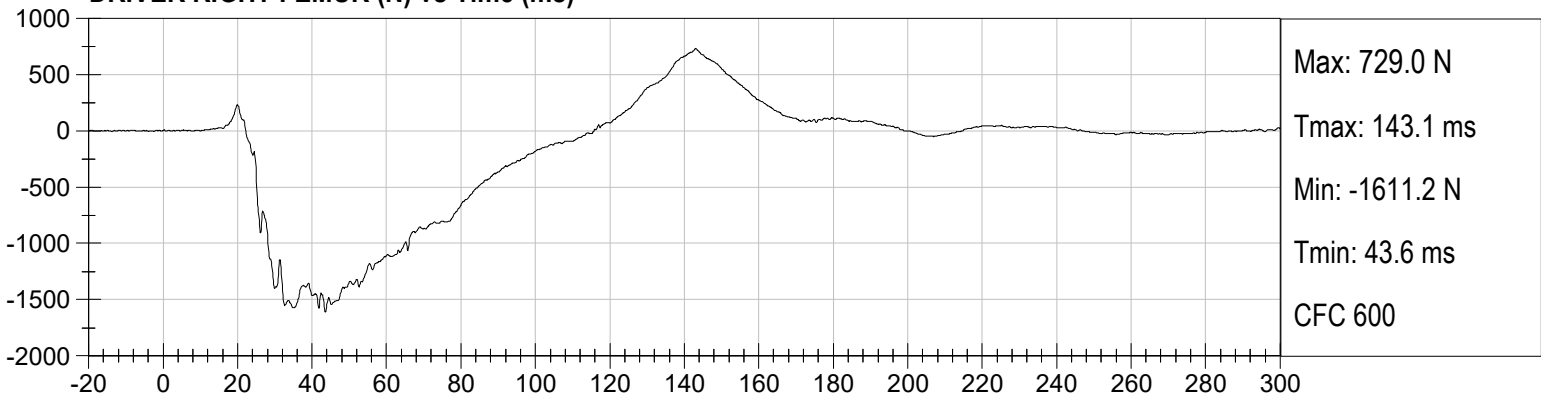

**PASSENGER HEAD X (g) vs Time (ms)**

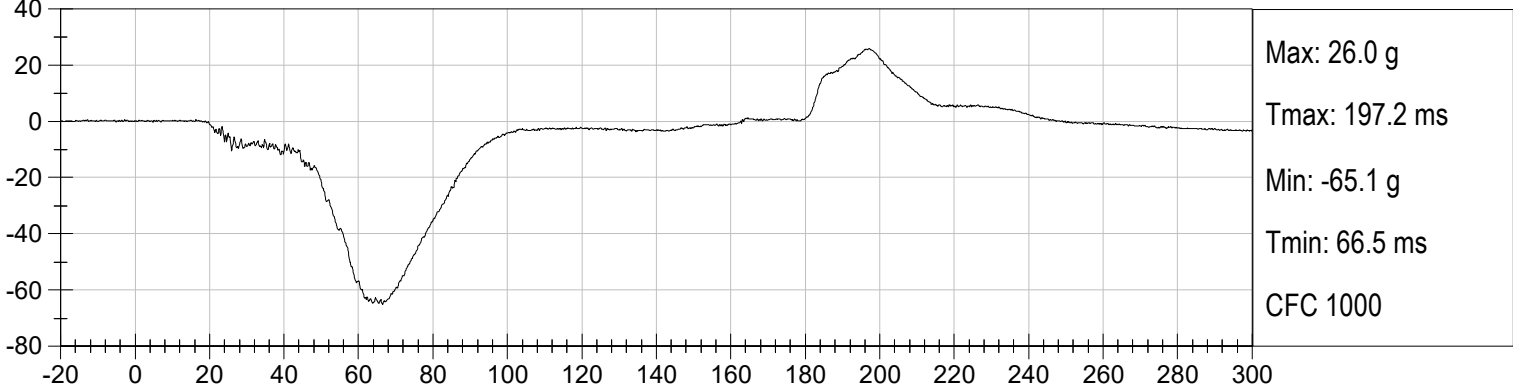

**PASSENGER HEAD Y (g) vs Time (ms)**

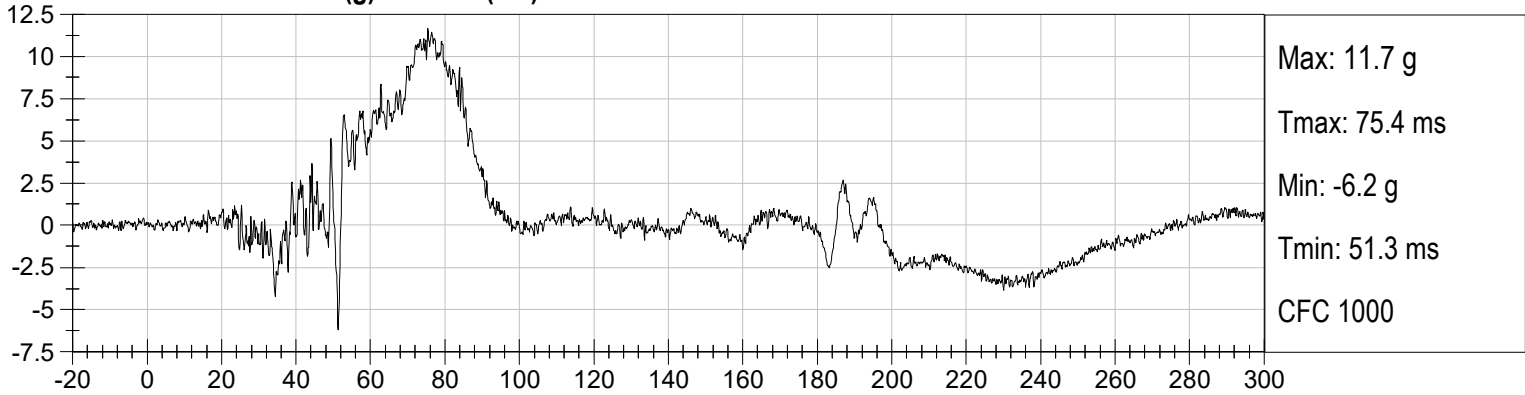

**PASSENGER HEAD Z (g) vs Time (ms)**

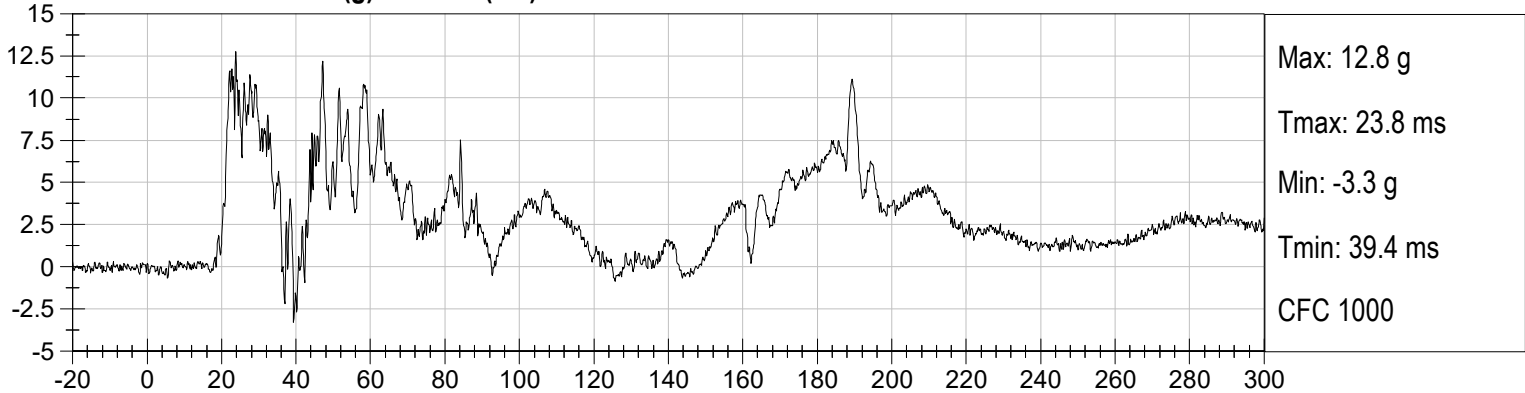

**PASSENGER HEAD Resultant (g) vs Time (ms)**

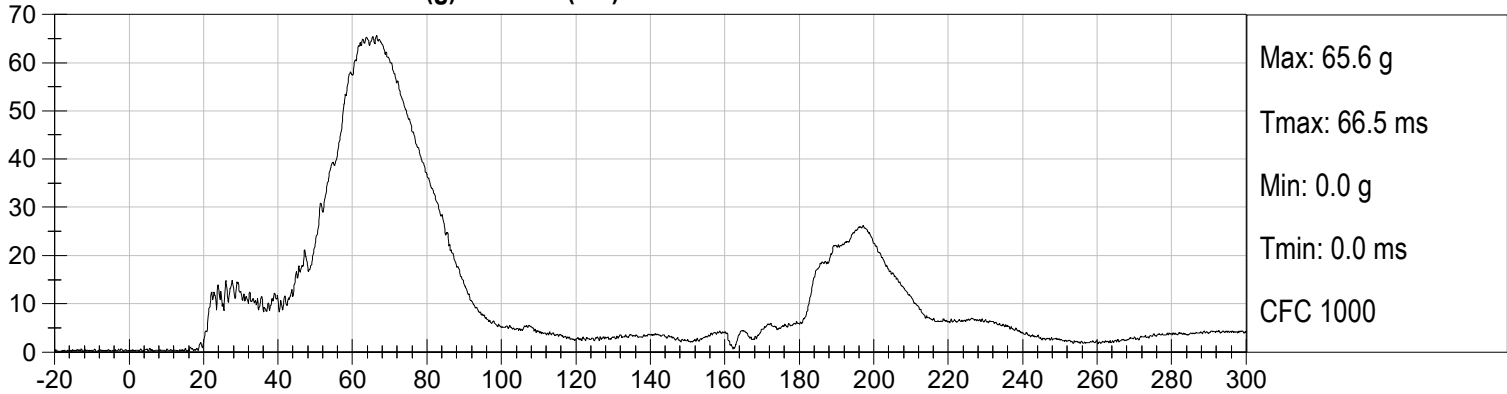

**PASSENGER HEAD X Velocity (kph) vs Time (ms)**

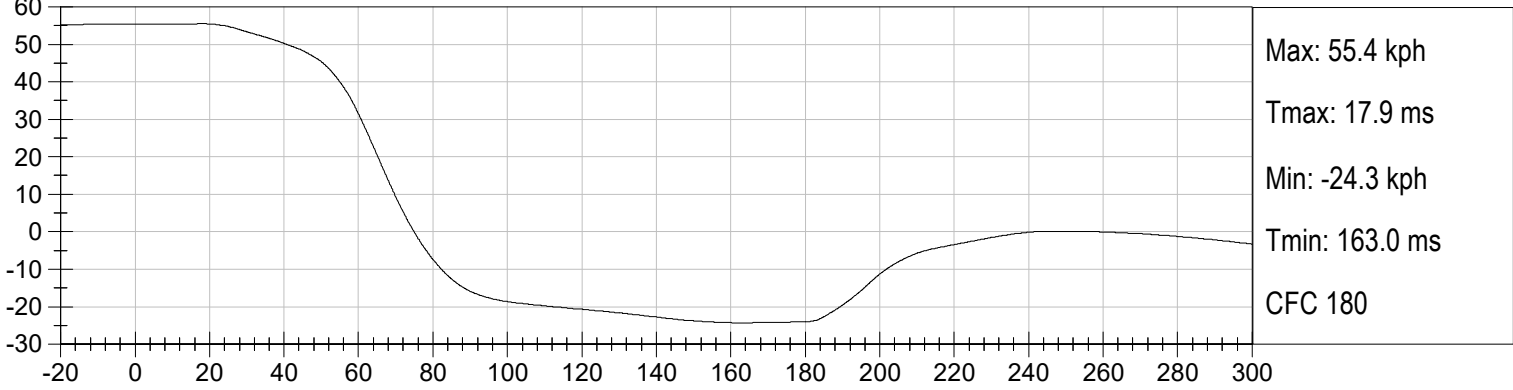

**PASSENGER HEAD Y Velocity (kph) vs Time (ms)**

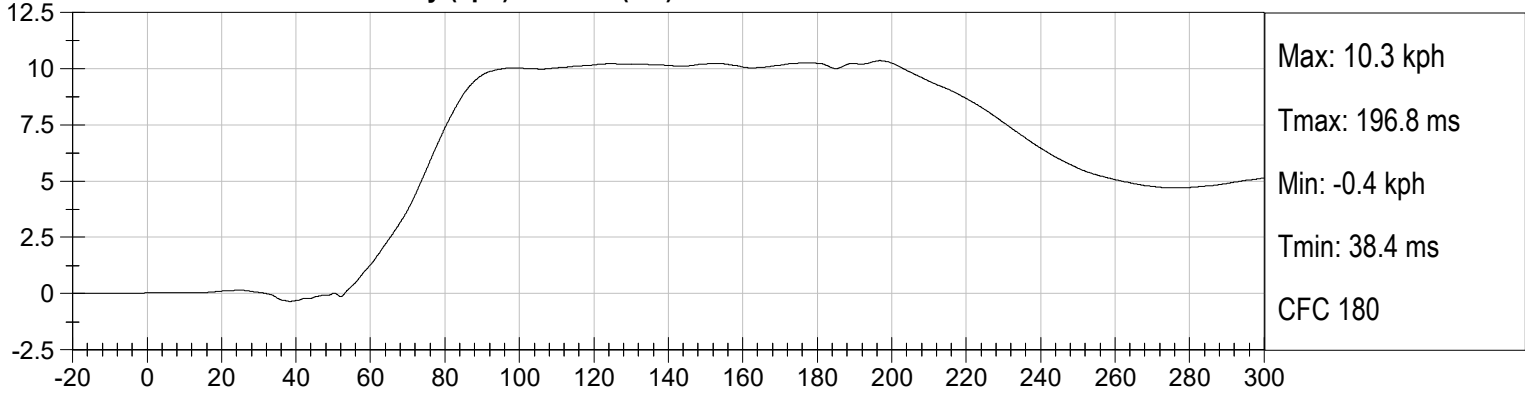

**PASSENGER HEAD Z Velocity (kph) vs Time (ms)**

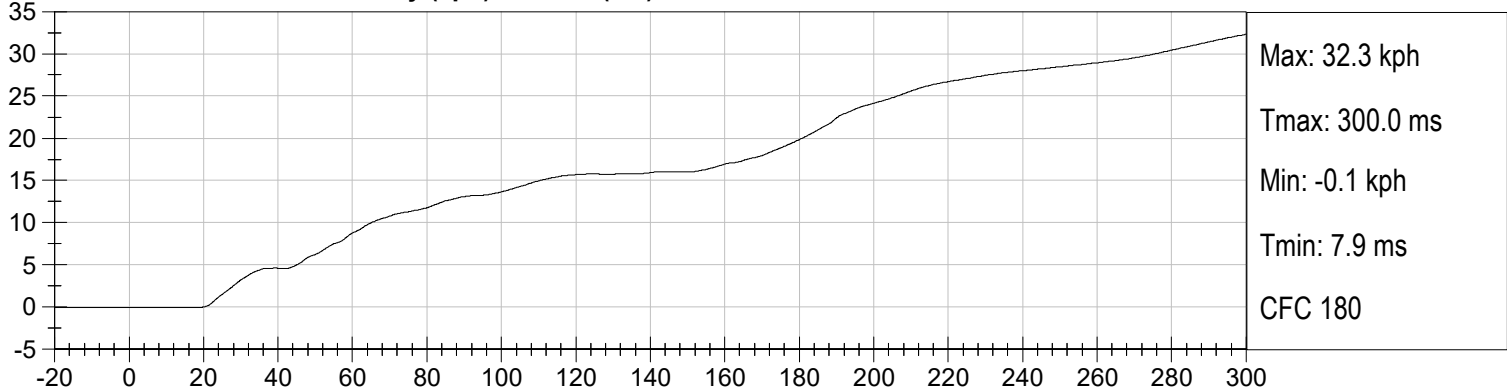

**PASSENGER NECK FX (N) vs Time (ms)**

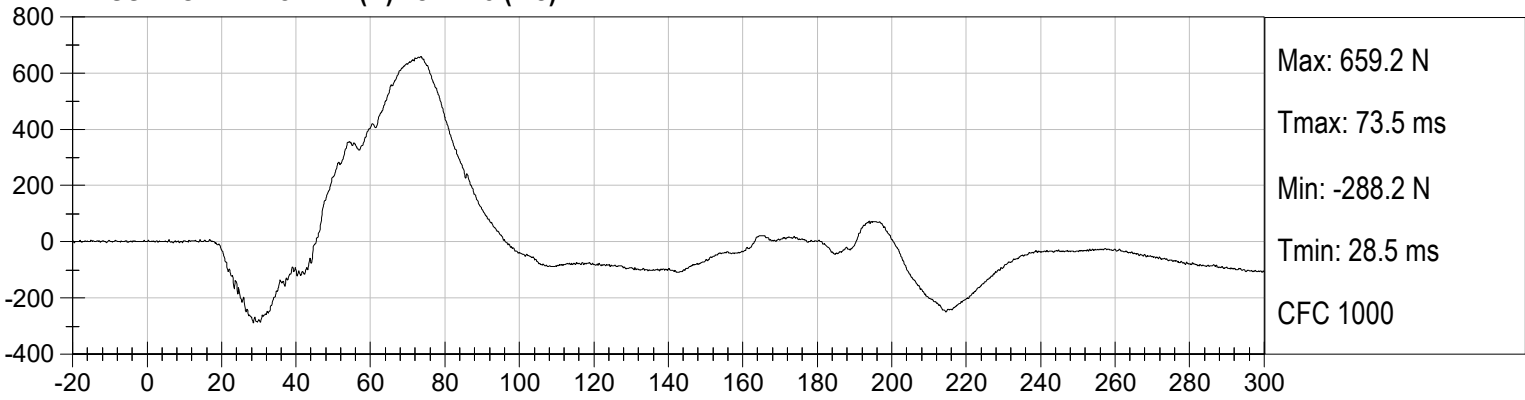

**PASSENGER NECK FY (N) vs Time (ms)**

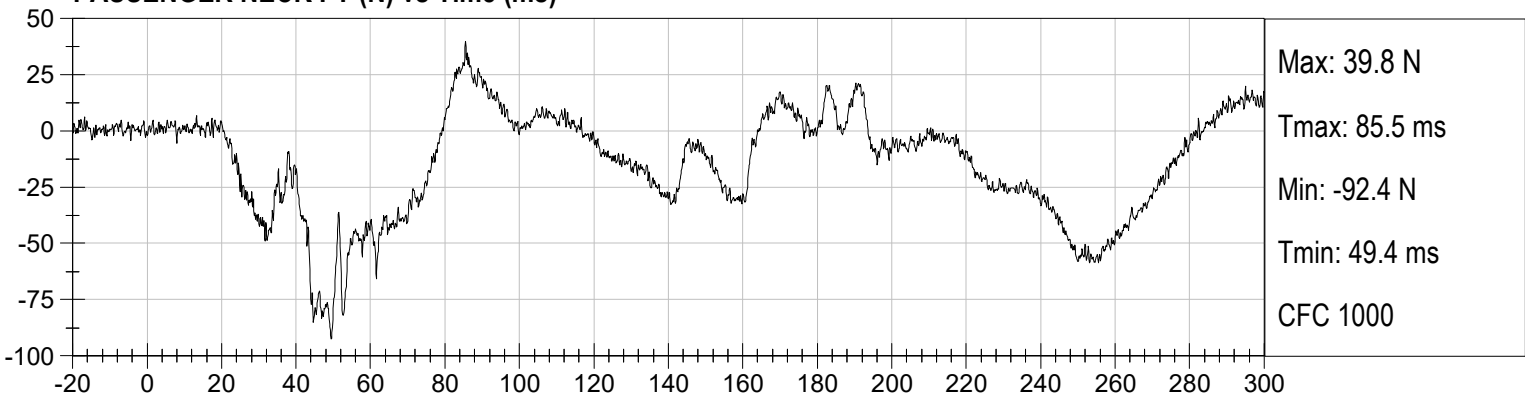

**PASSENGER NECK FZ (N) vs Time (ms)**

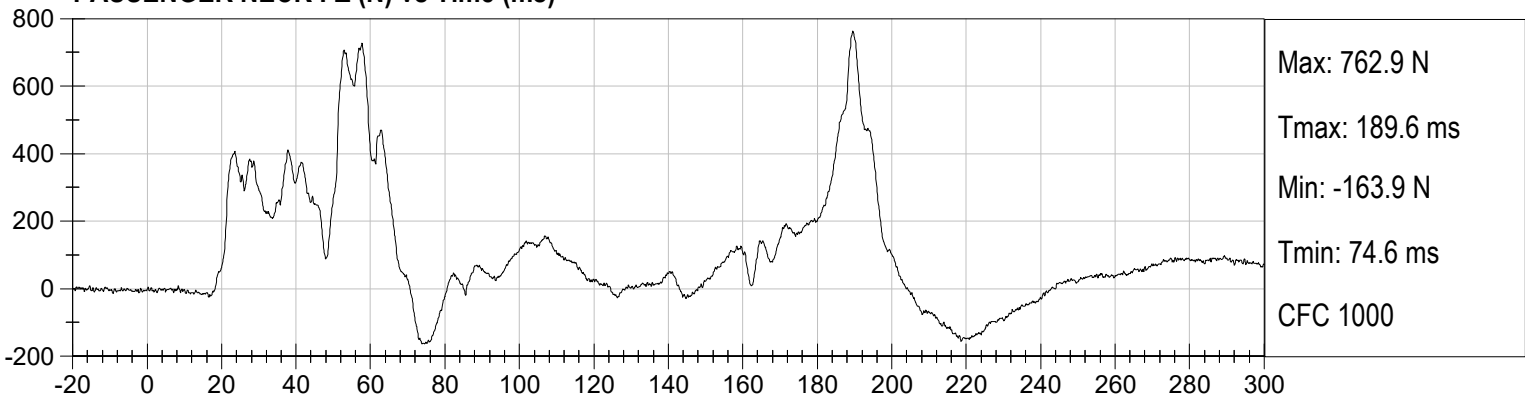

**PASSENGER NECK FResultant (N) vs Time (ms)**

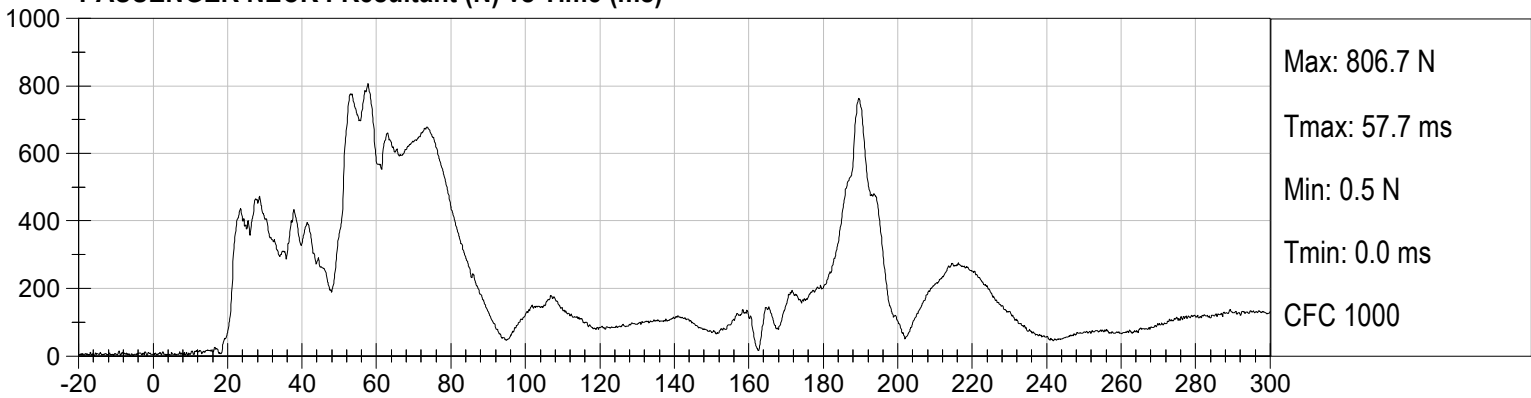

**PASSENGER NECK MX (Nm) vs Time (ms)**

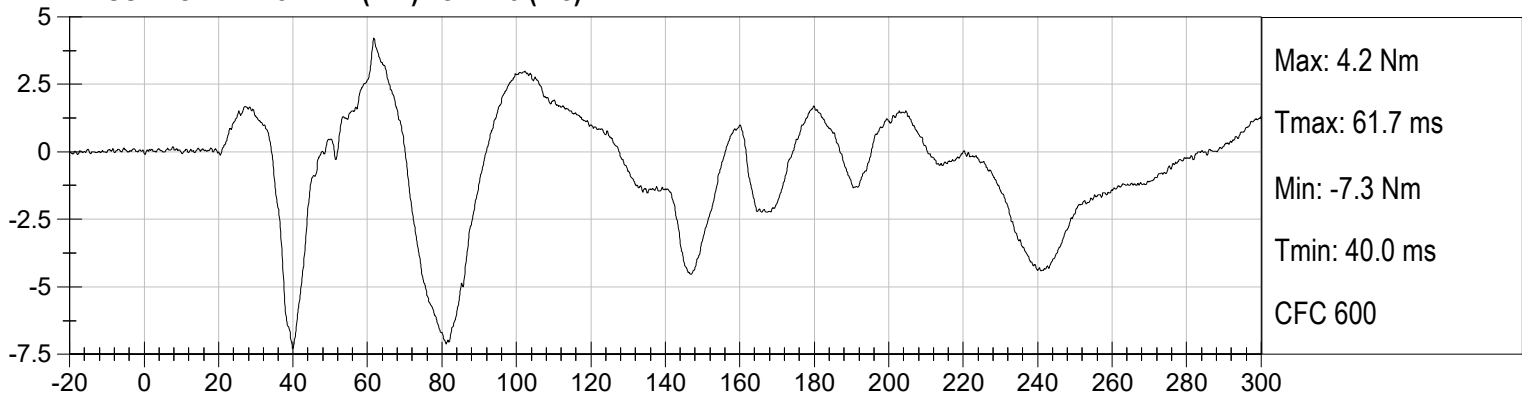

**PASSENGER NECK MY (Nm) vs Time (ms)**

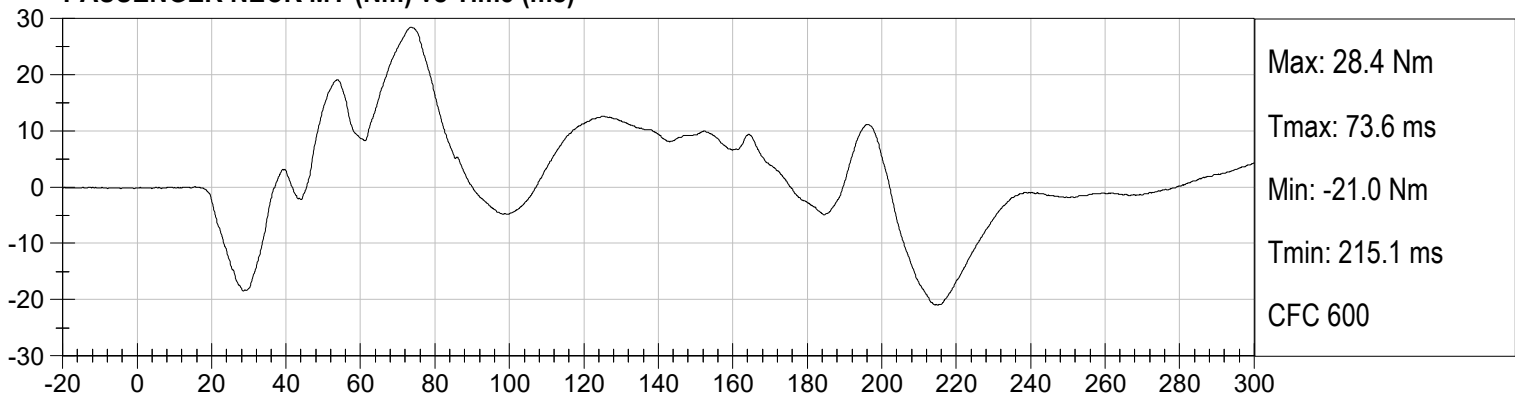

**PASSENGER NECK MZ (Nm) vs Time (ms)**

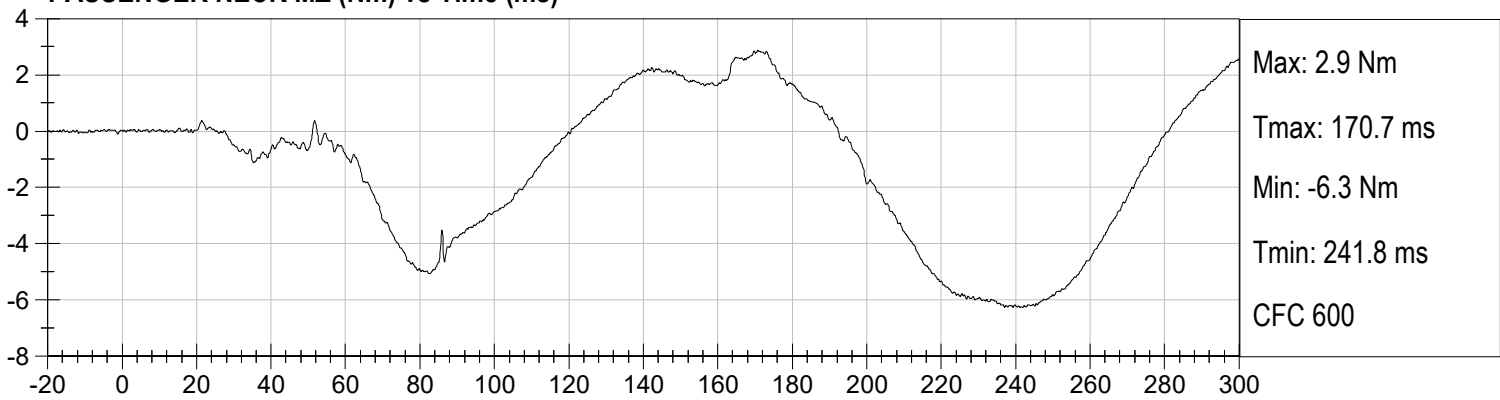

**PASSENGER NECK MResultant (Nm) vs Time (ms)**

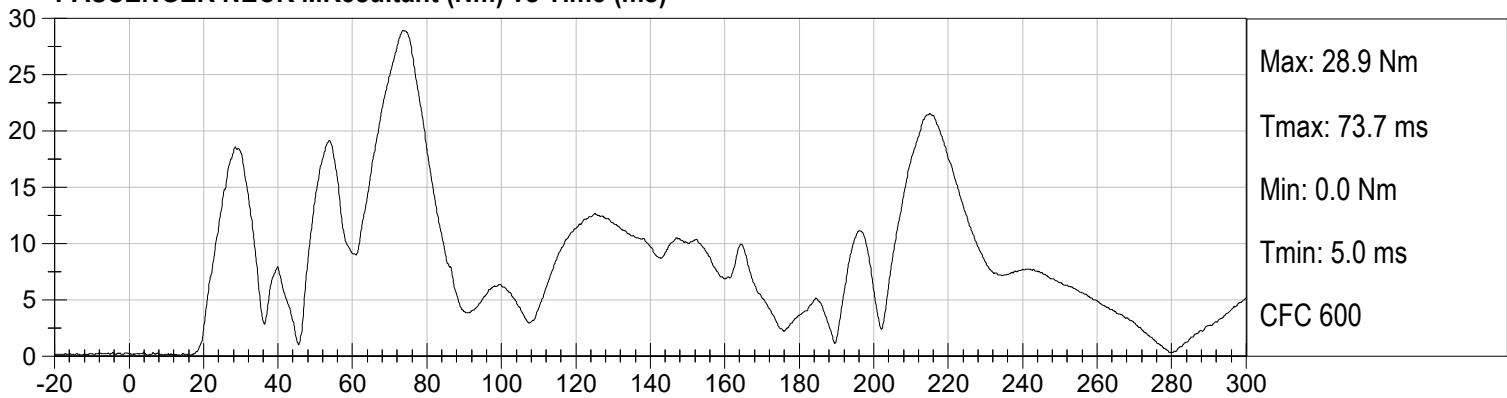

**PASSENGER CHEST X (g) vs Time (ms)**

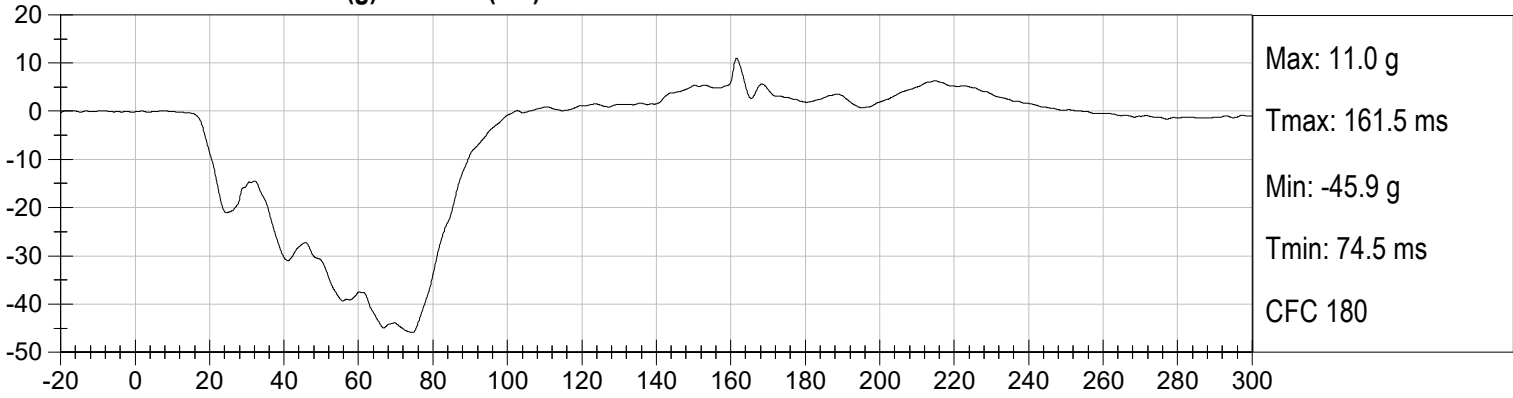

**PASSENGER CHEST Y (g) vs Time (ms)**

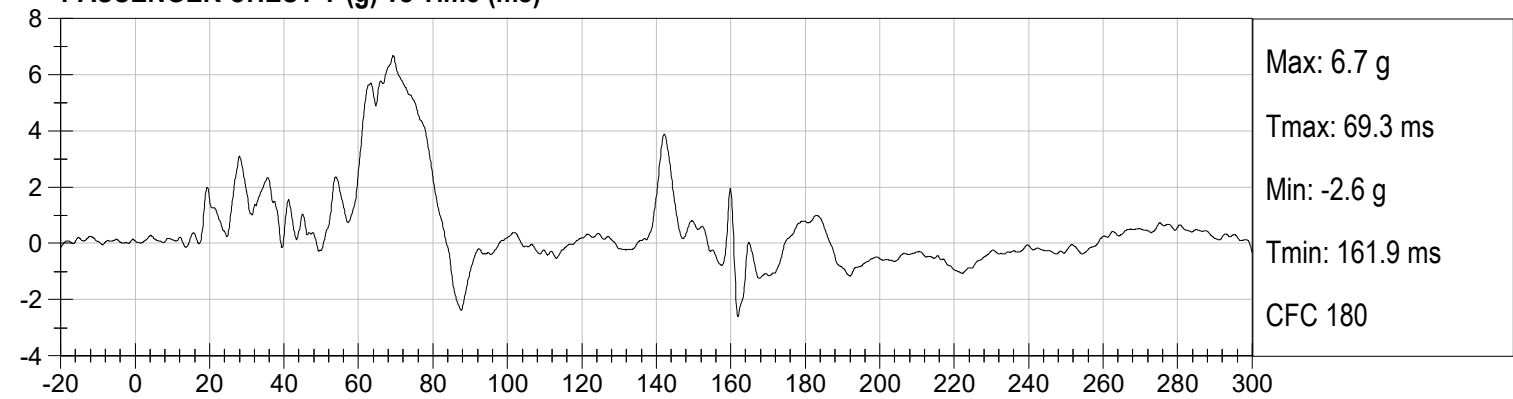

**PASSENGER CHEST Z (g) vs Time (ms)**

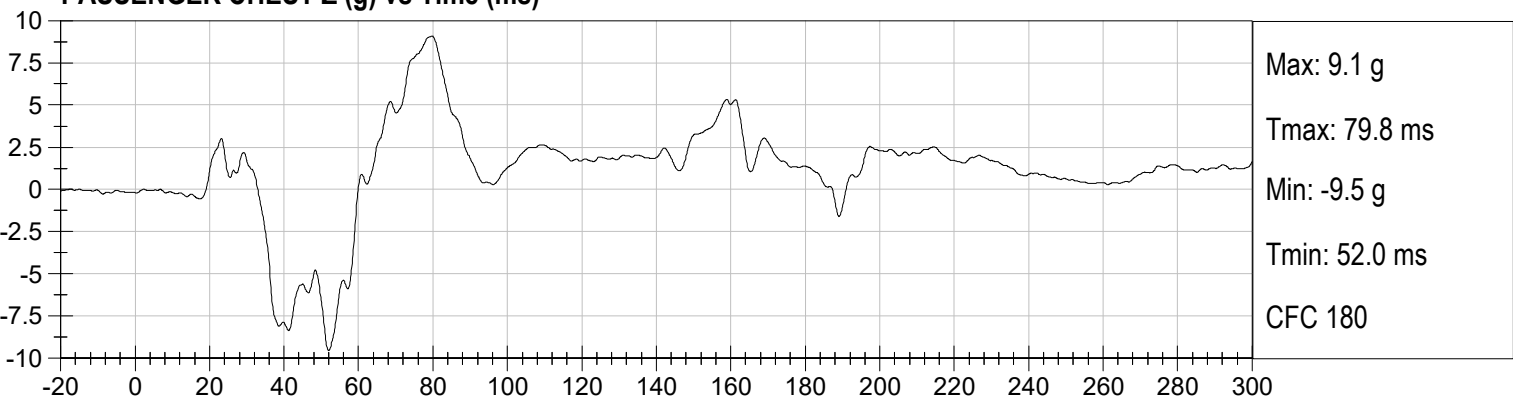

**PASSENGER CHEST Resultant (g) vs Time (ms)**

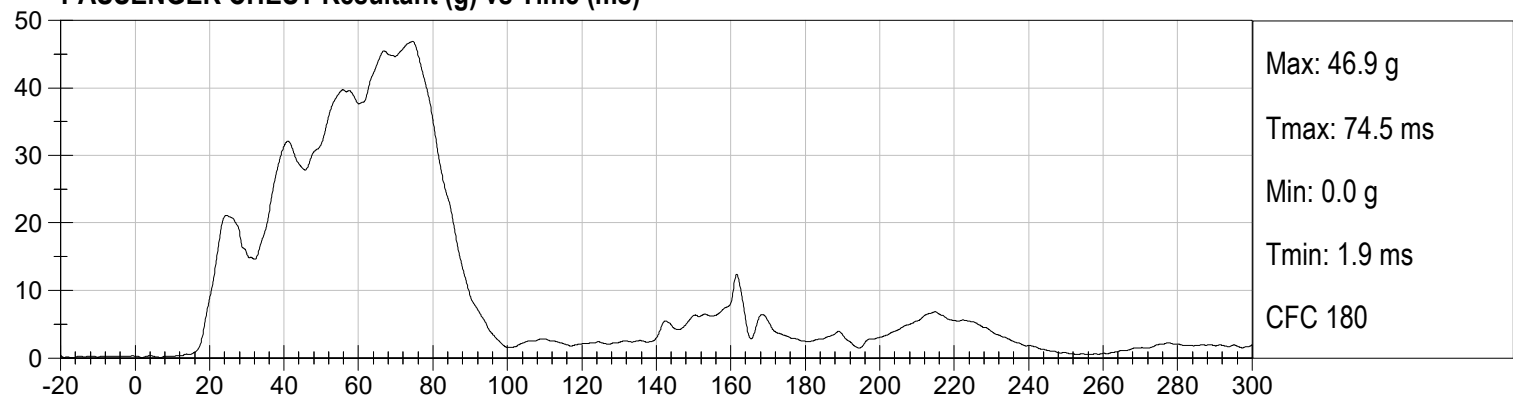

**PASSENGER CHEST X Velocity (kph) vs Time (ms)**

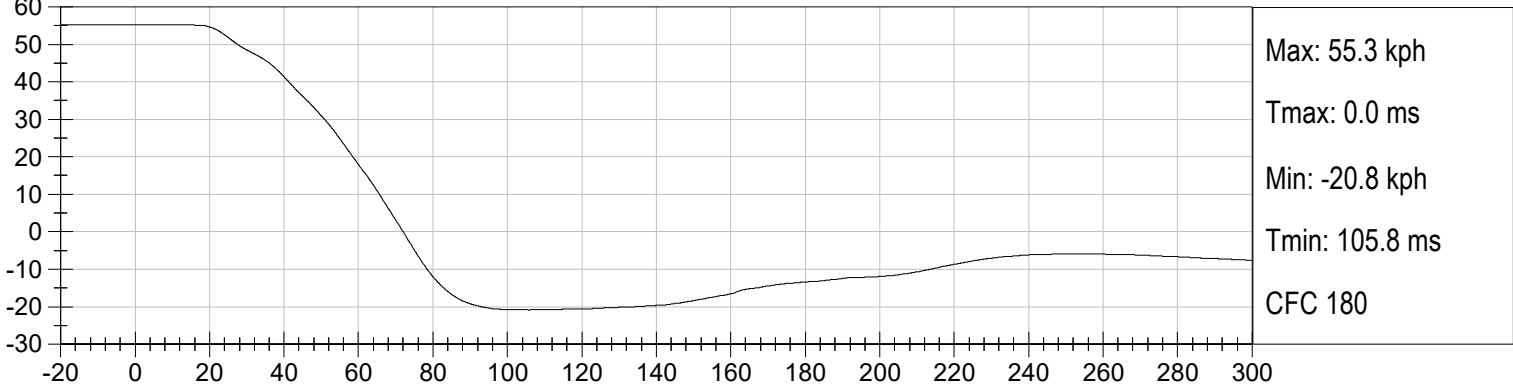

**PASSENGER CHEST Y Velocity (kph) vs Time (ms)**

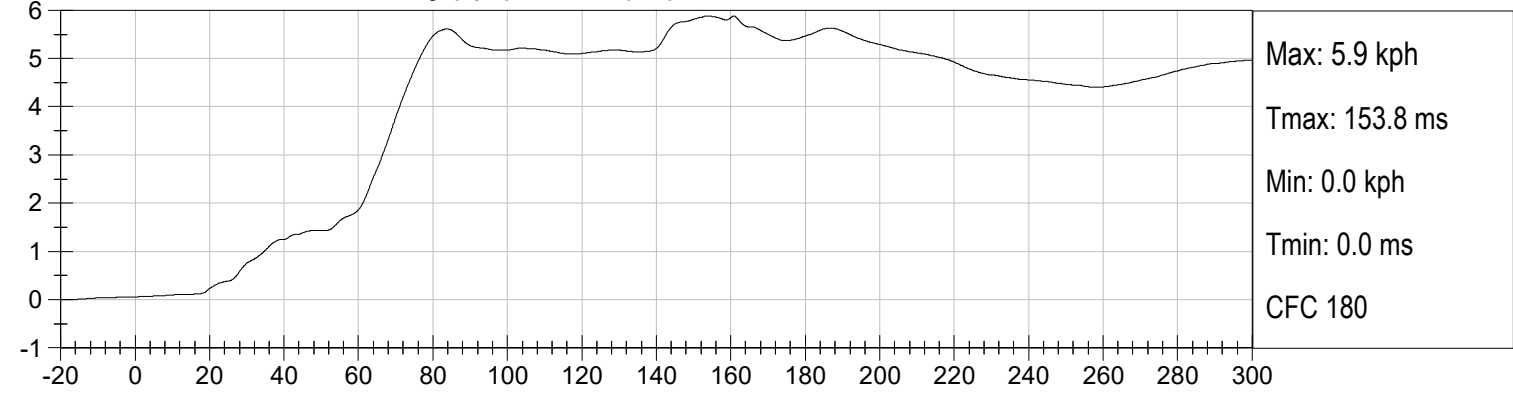

**PASSENGER CHEST Z Velocity (kph) vs Time (ms)**

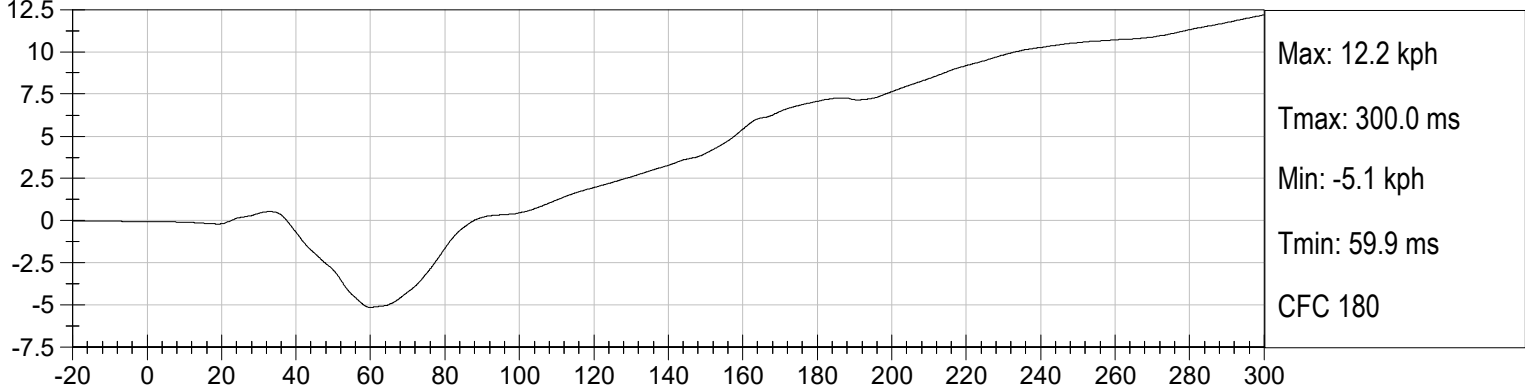

**PASSENGER CHEST DISPLACEMENT (mm) vs Time (ms)**

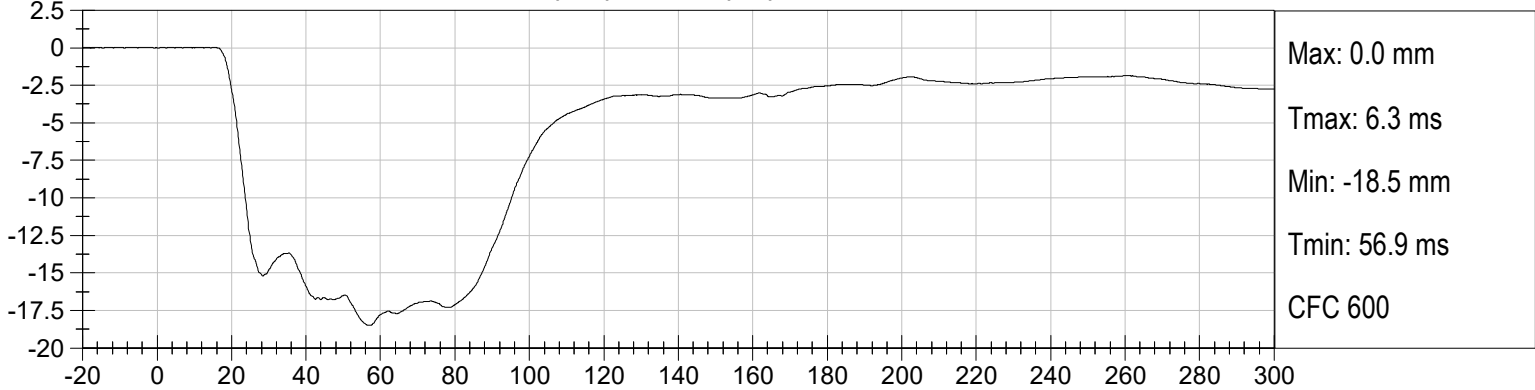

**PASSENGER LEFT FEMUR (N) vs Time (ms)**

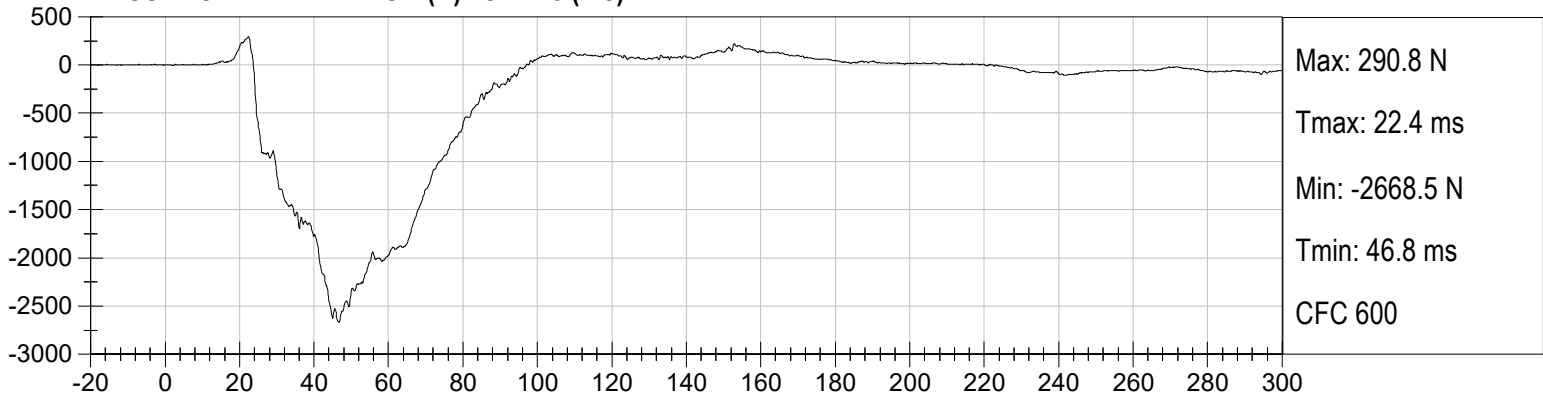

**PASSENGER RIGHT FEMUR (N) vs Time (ms)**

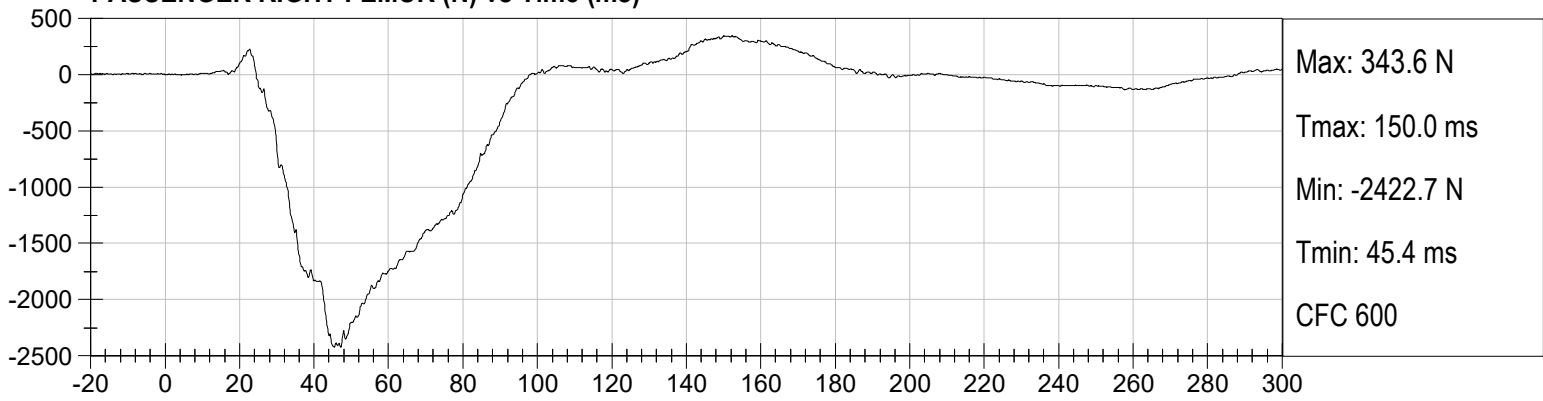

**DRIVER Nij (NTF) vs Time (ms)**

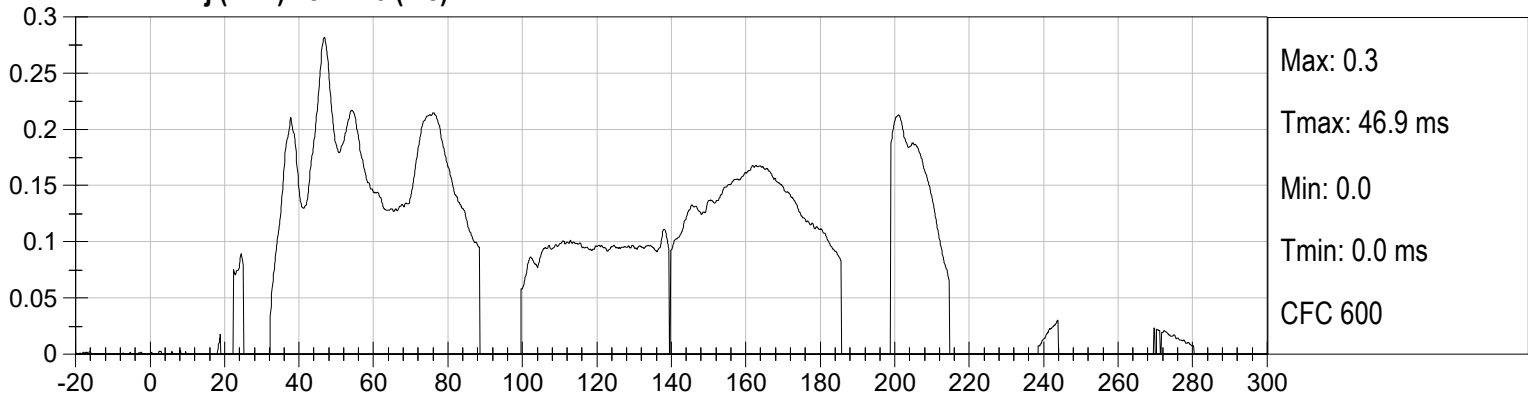

**DRIVER Nij (NTE) vs Time (ms)**

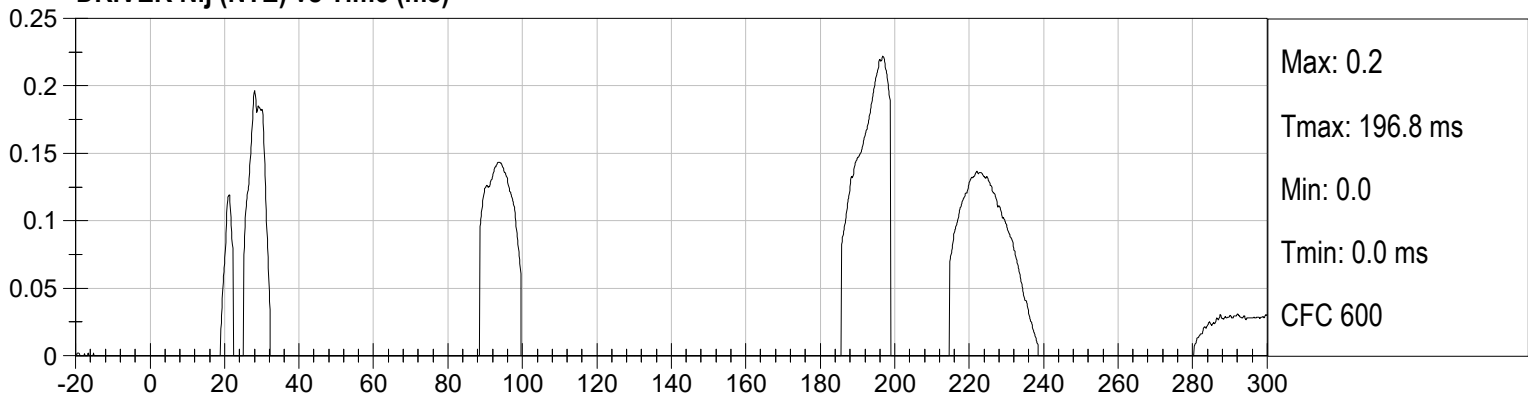

**DRIVER Nij (NCF) vs Time (ms)**

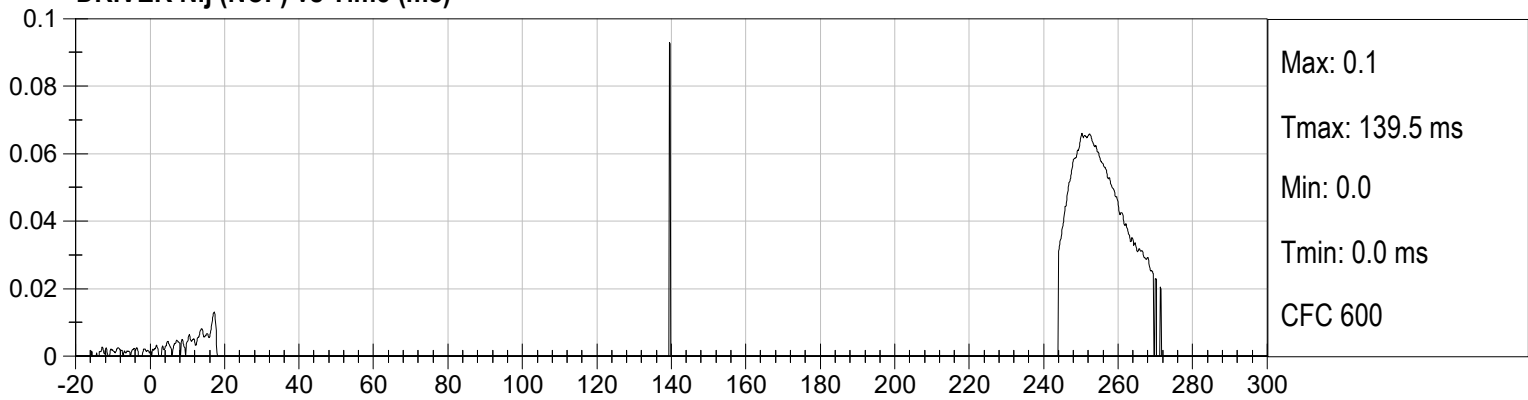

**DRIVER Nij (NCE) vs Time (ms)**

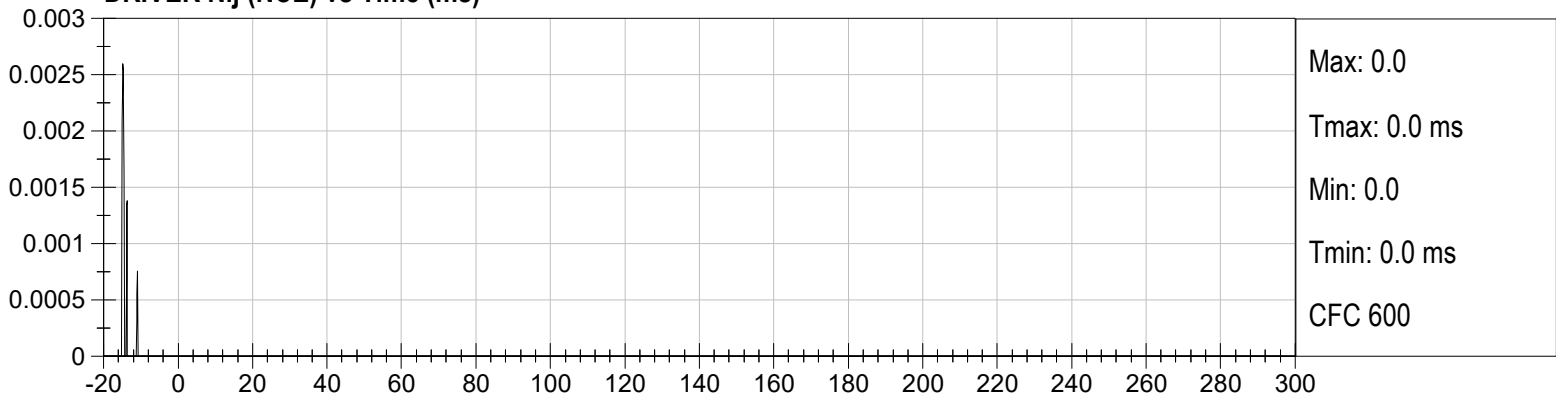

**PASSENGER Nij (NTF) vs Time (ms)**

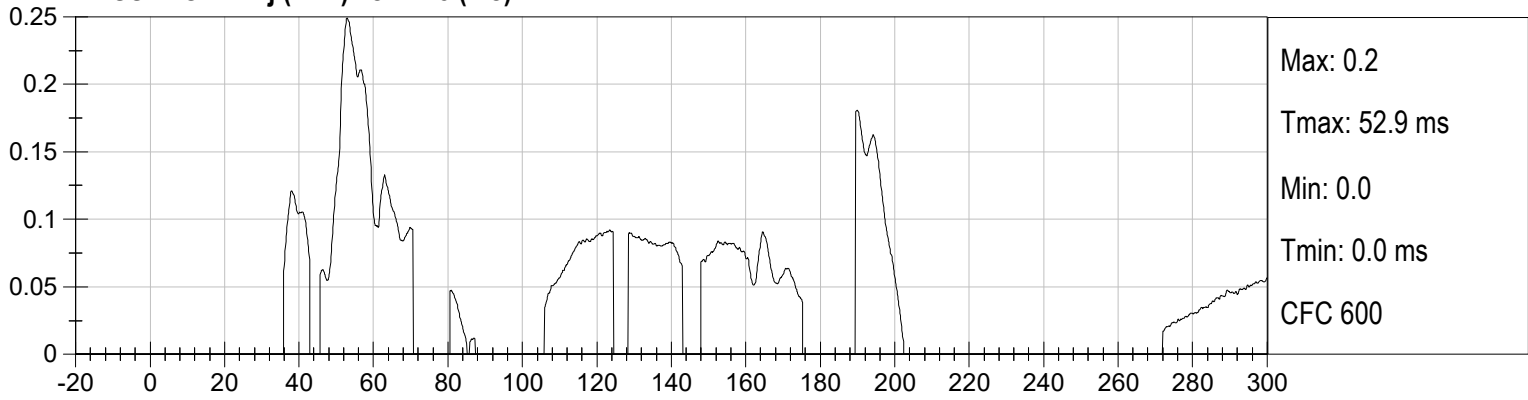

**PASSENGER Nij (NTE) vs Time (ms)**

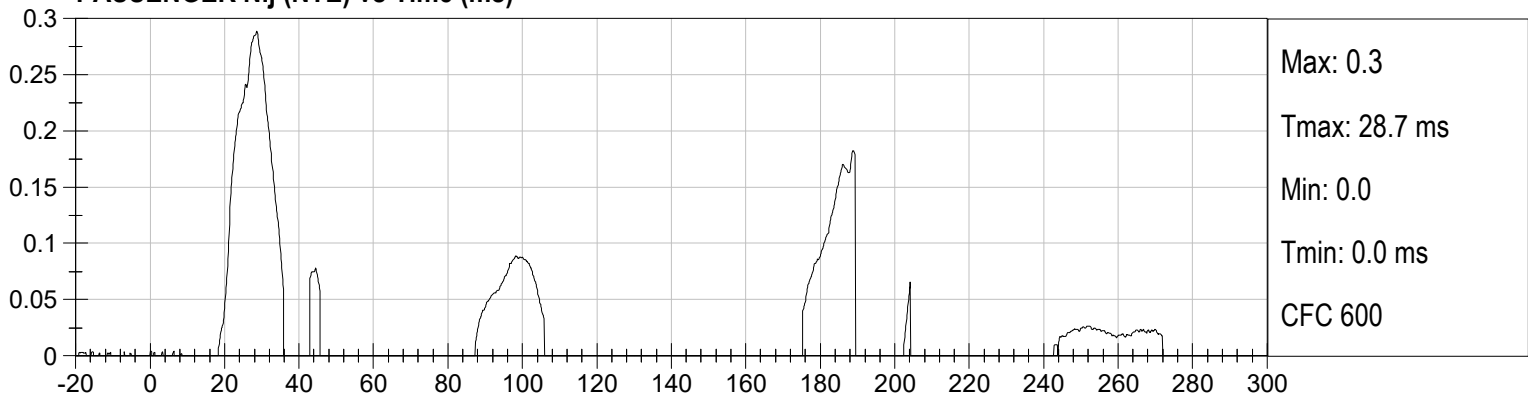

**PASSENGER Nij (NCF) vs Time (ms)**

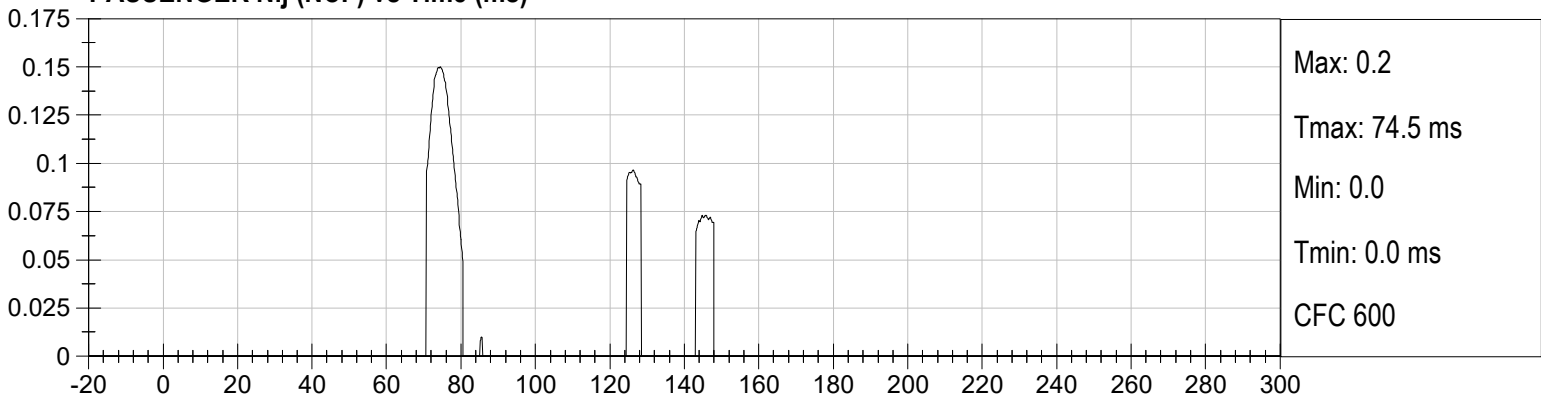

**PASSENGER Nij (NCE) vs Time (ms)**

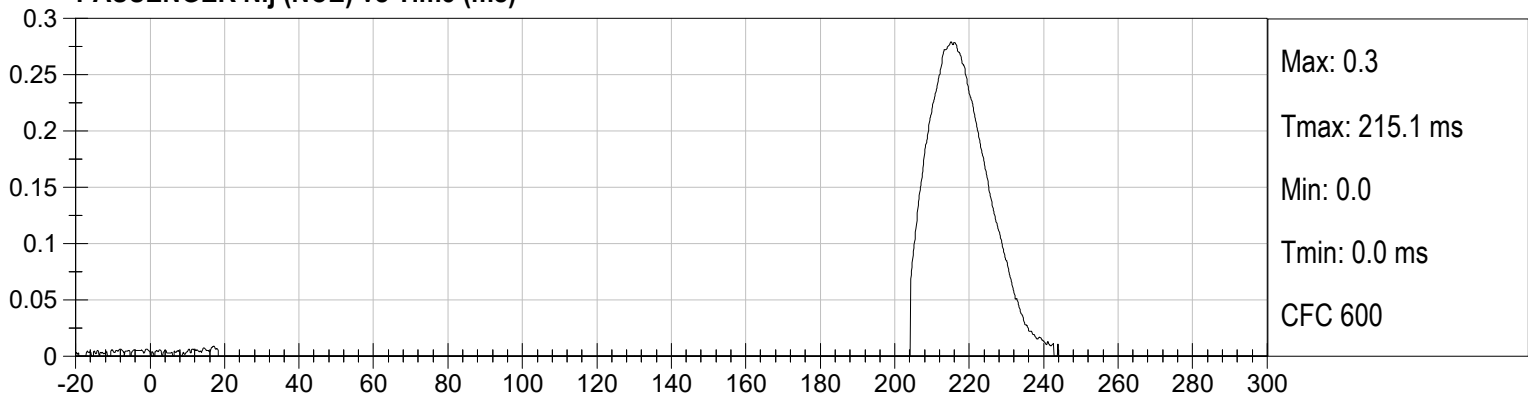

**DRIVER NECK MY Occipital Condyle (Nm) vs Time (ms)**

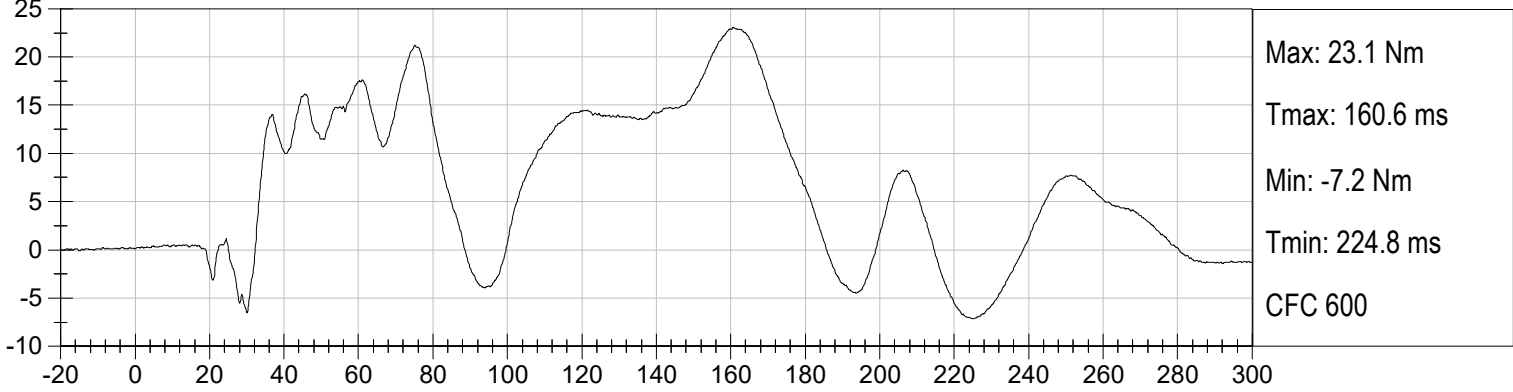

**PASSENGER NECK MY Occipital Condyle (Nm) vs Time (ms)**

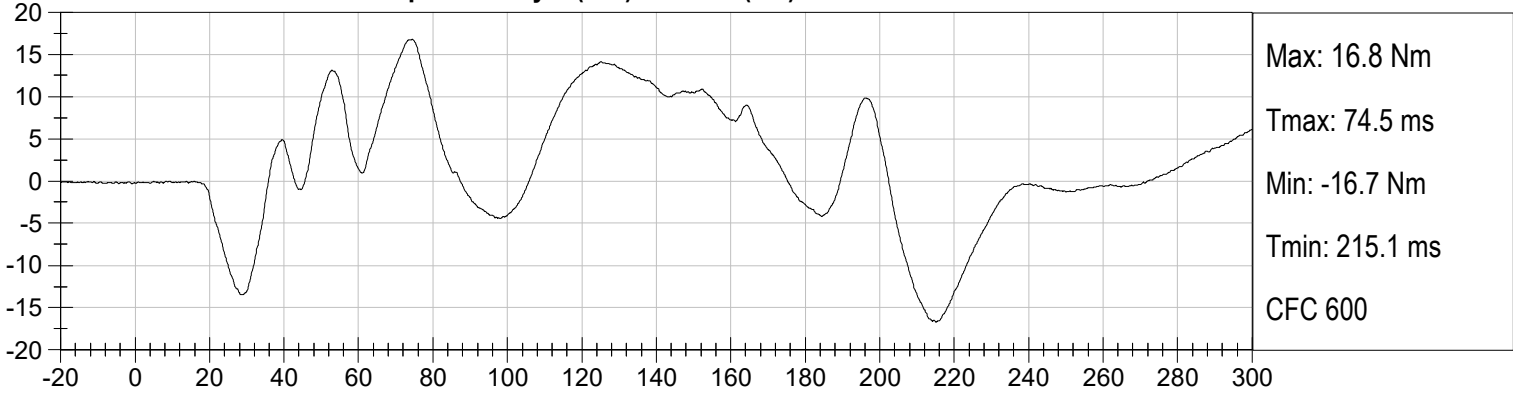

**LEFT REAR SEAT CROSSMEMBER X (g) vs Time (ms)**

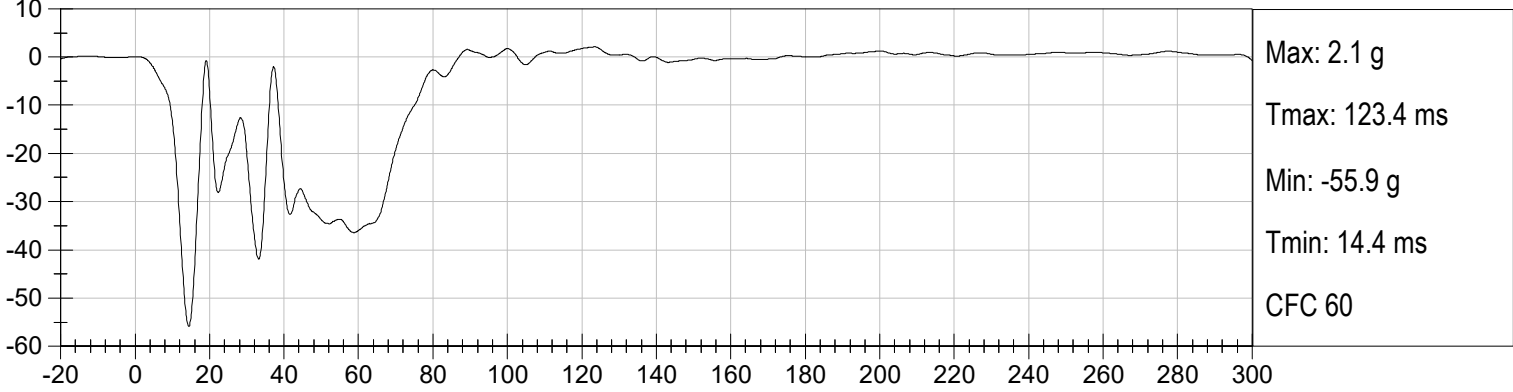

**LEFT REAR SEAT CROSSMEMBER X Velocity (kph) vs Time (ms)**

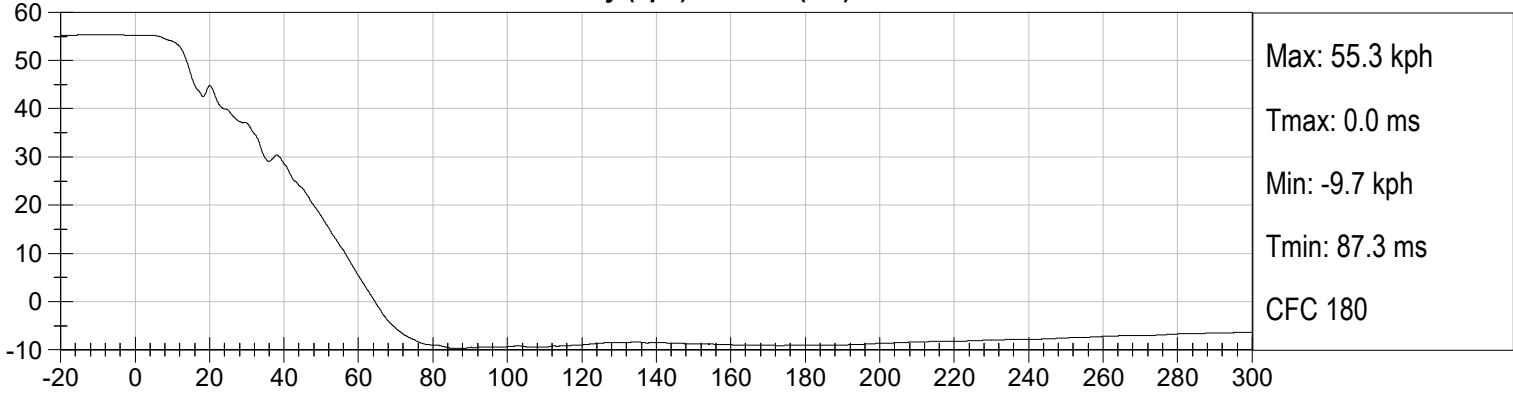

**RIGHT REAR SEAT CROSSMEMBER X (g) vs Time (ms)**

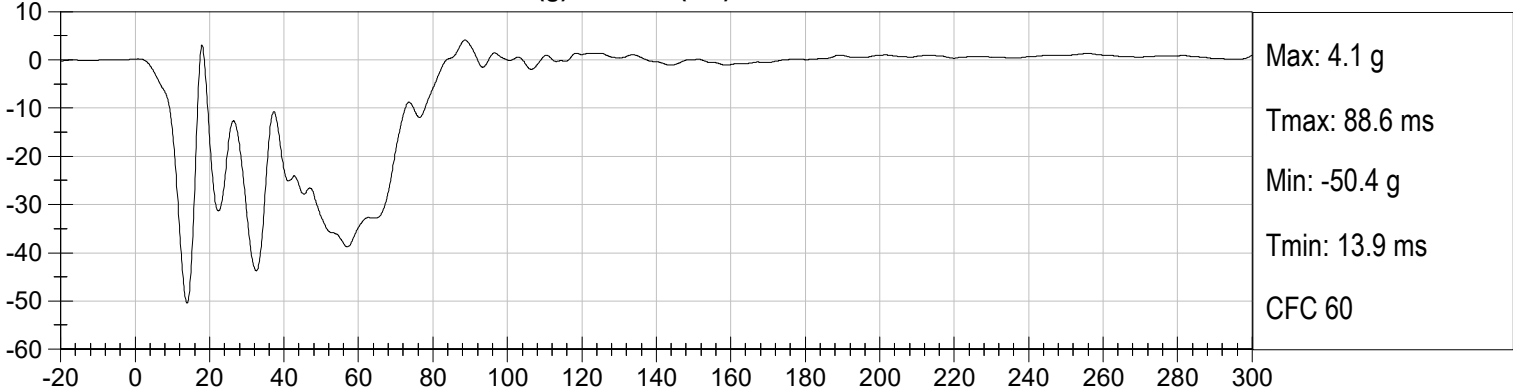

**RIGHT REAR SEAT CROSSMEMBER X Velocity (kph) vs Time (ms)**

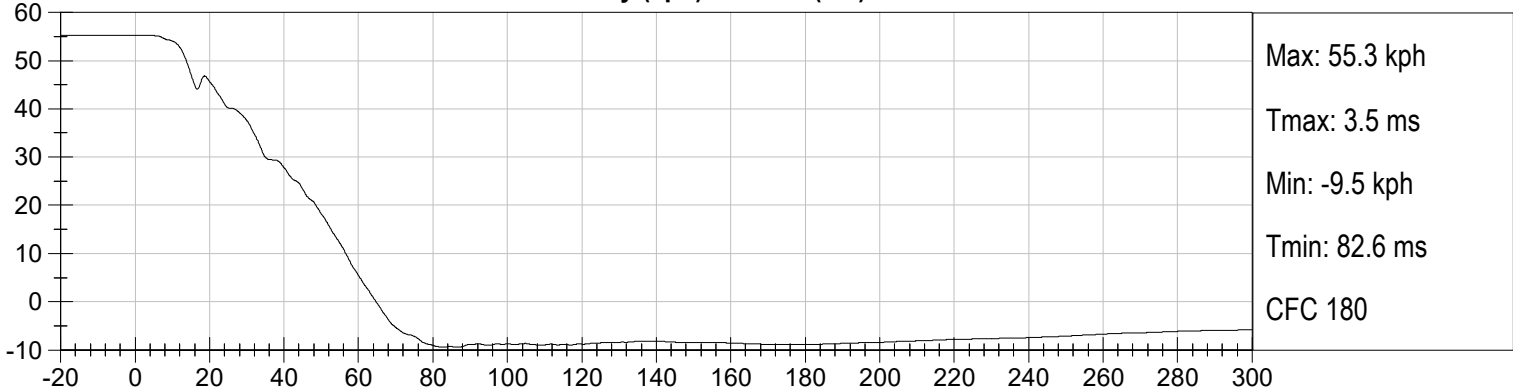

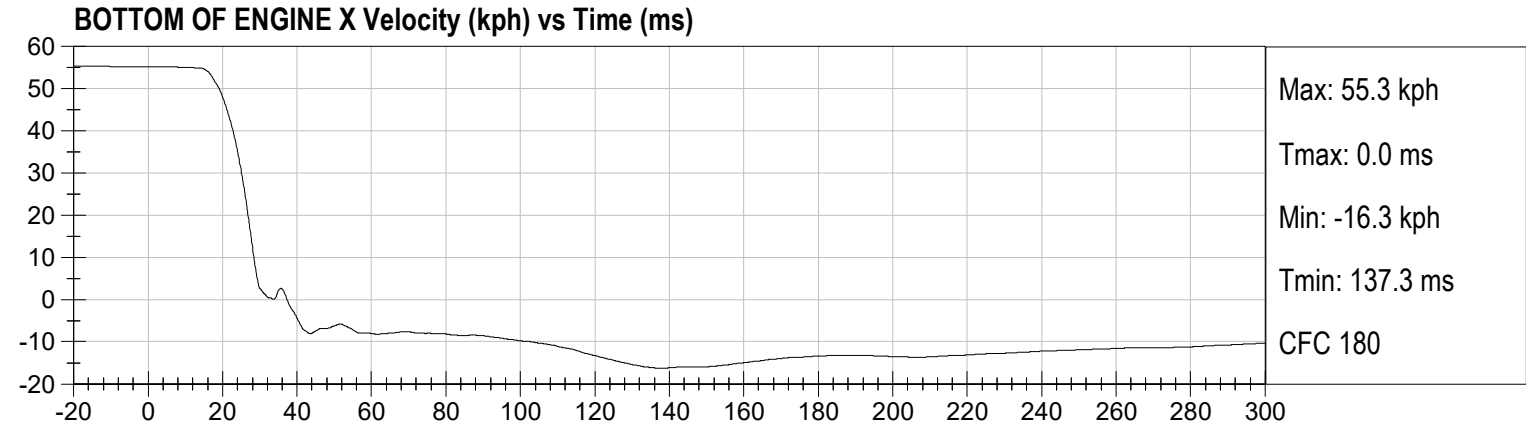
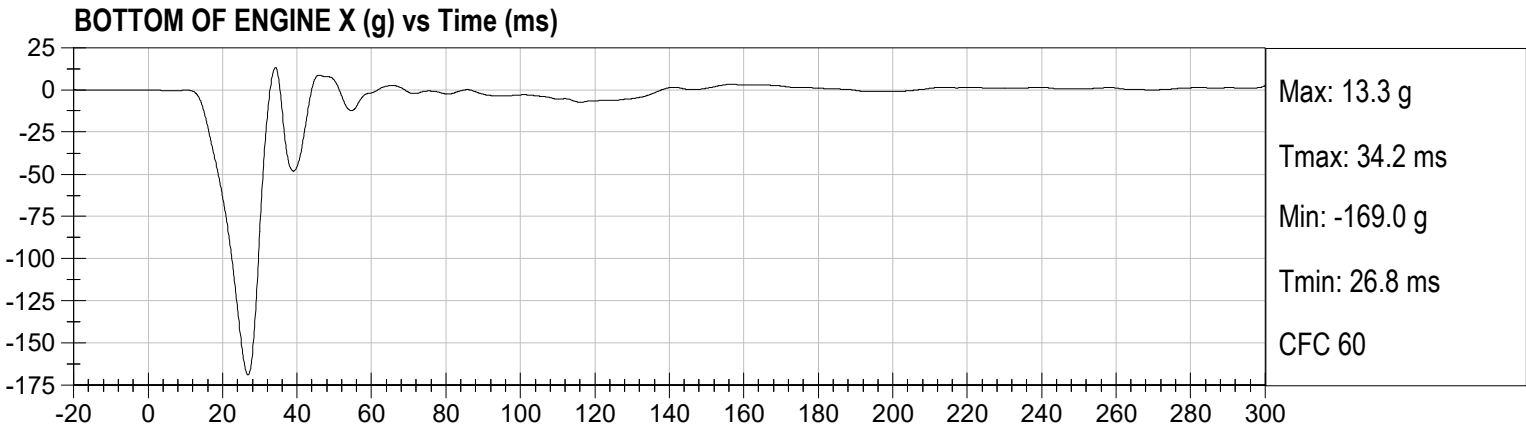
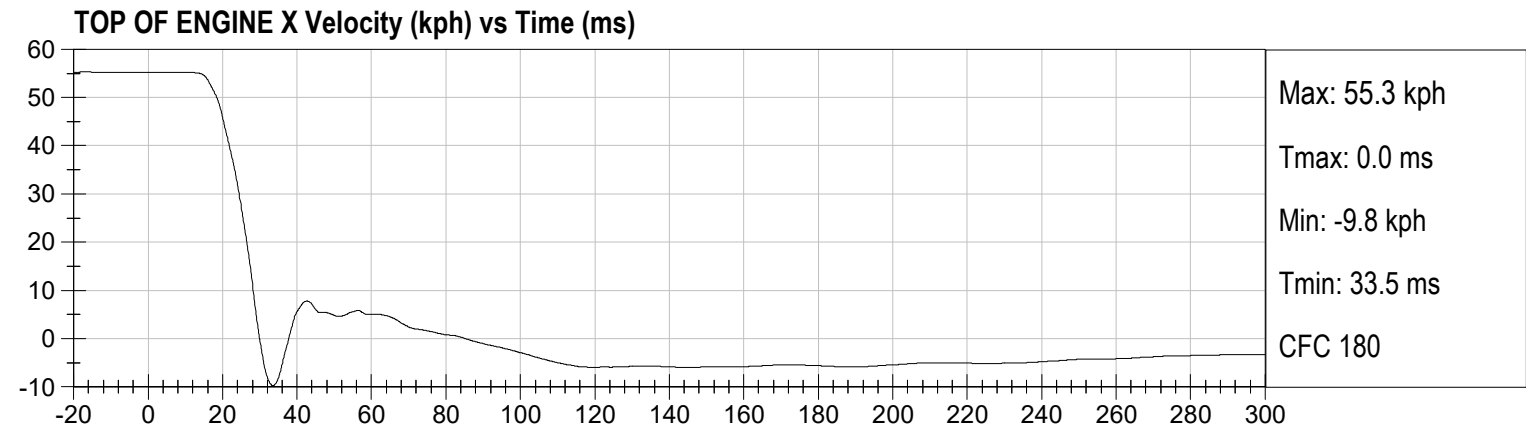
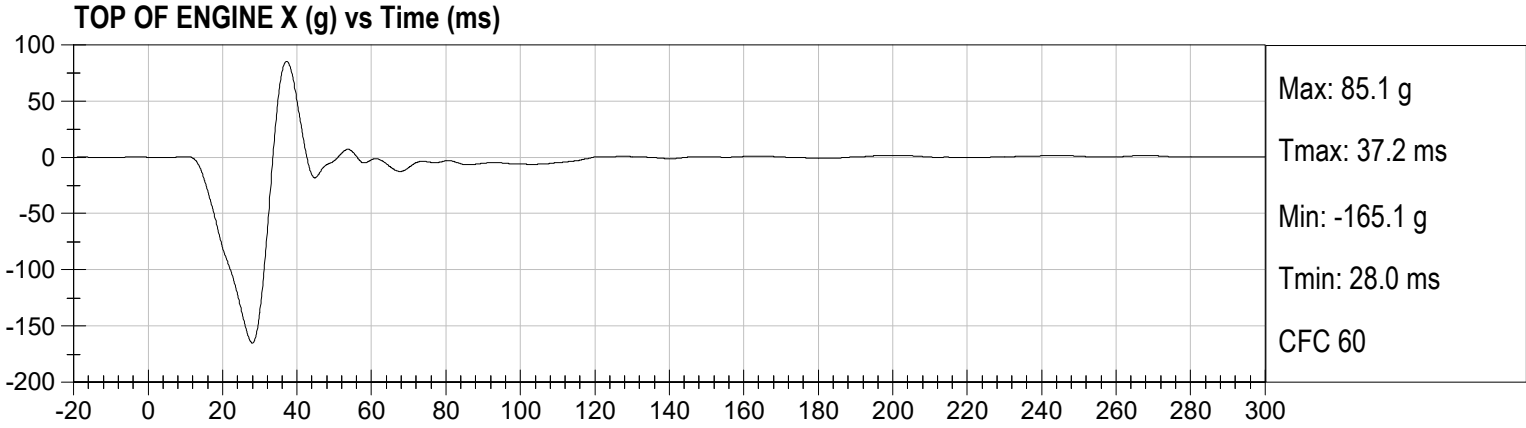

**LEFT BRAKE CALIPER X (g) vs Time (ms)**

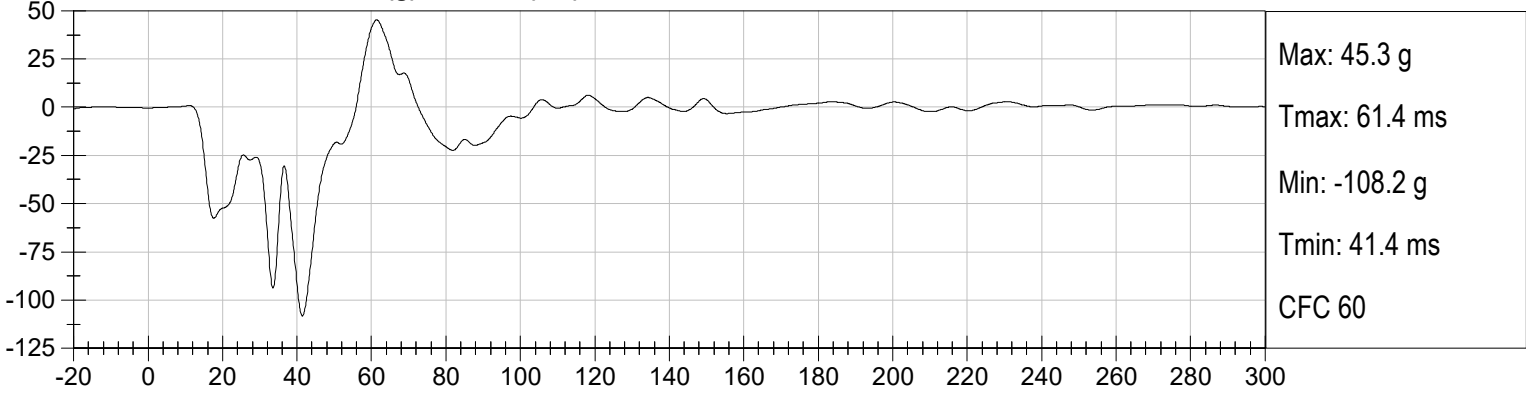

**LEFT BRAKE CALIPER X Velocity (kph) vs Time (ms)**

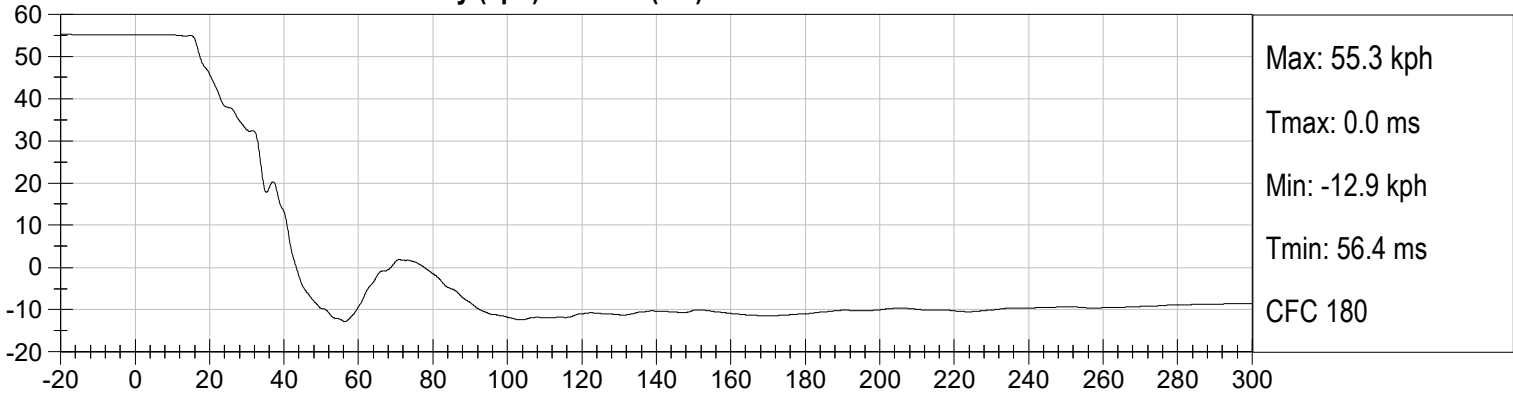

**RIGHT BRAKE CALIPER X (g) vs Time (ms)**

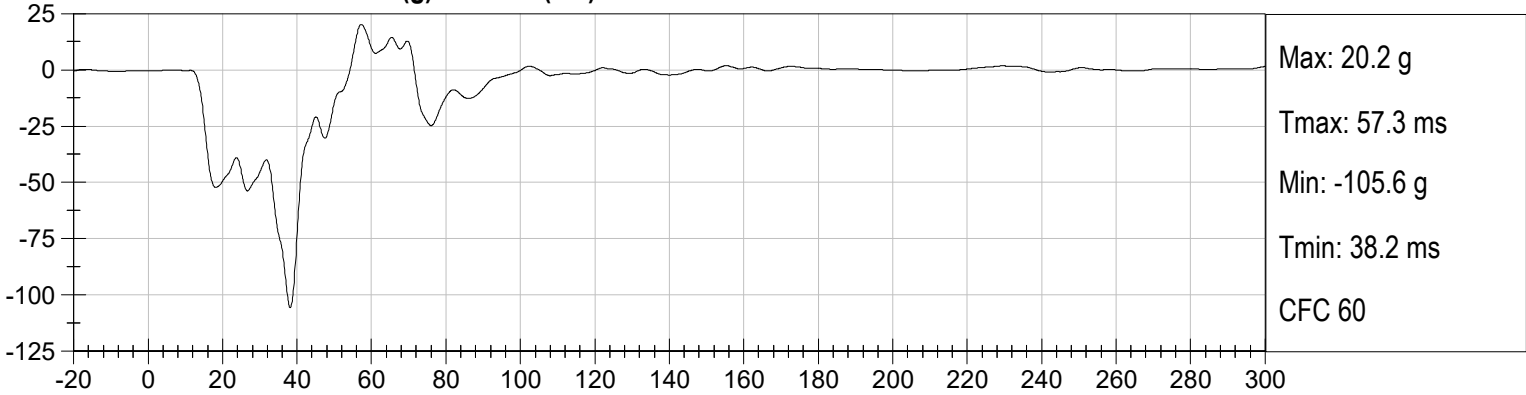

**RIGHT BRAKE CALIPER X Velocity (kph) vs Time (ms)**

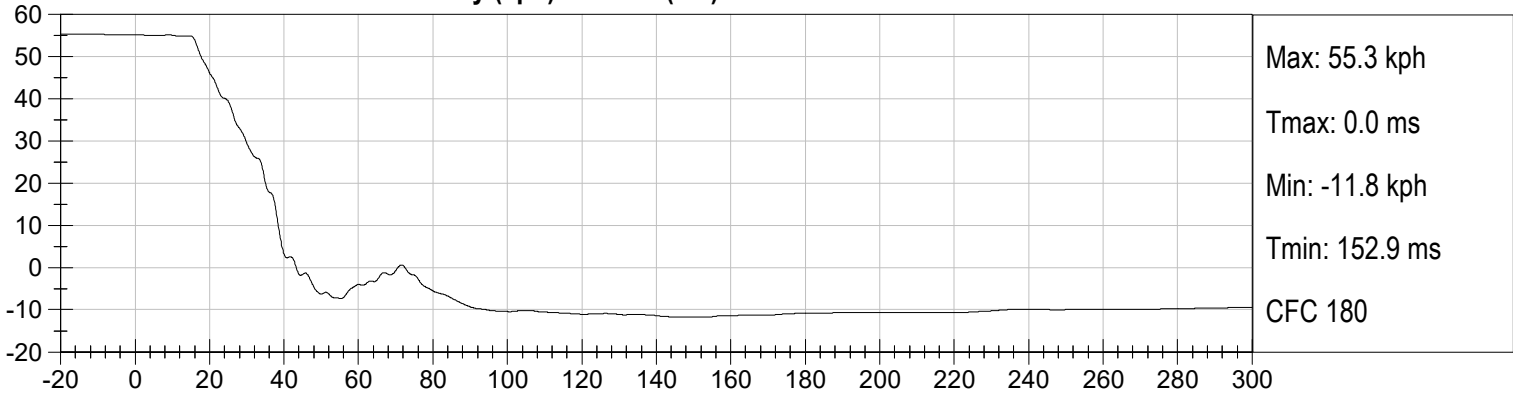

**INSTRUMENT PANEL X (g) vs Time (ms)**

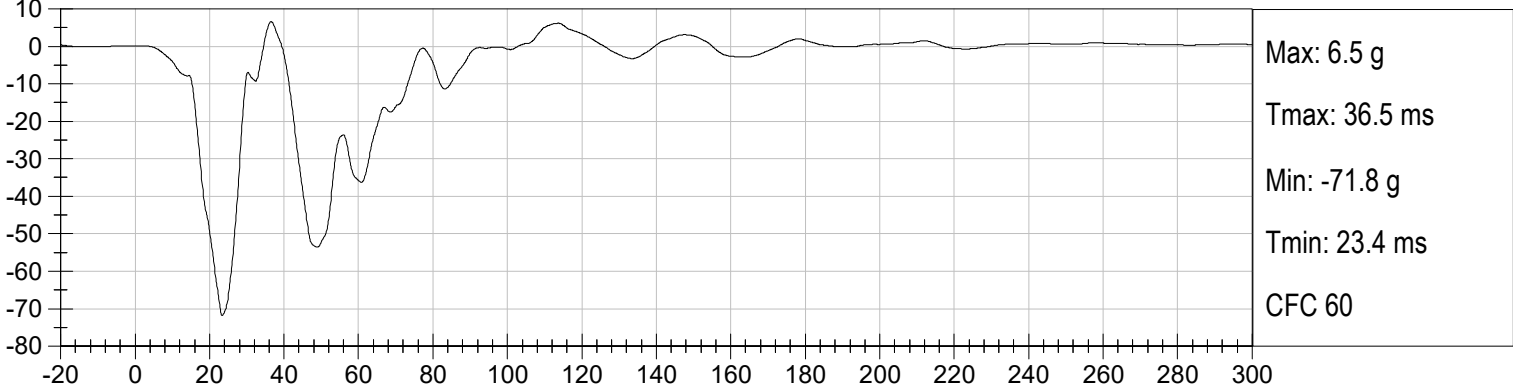

**INSTRUMENT PANEL X Velocity (kph) vs Time (ms)**

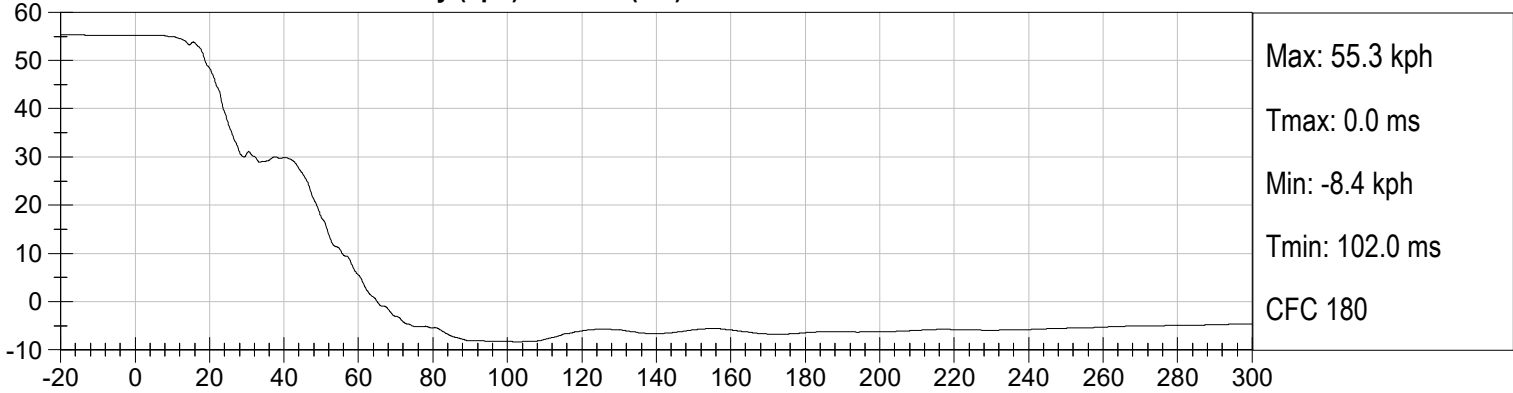

**TRUNK Z (g) vs Time (ms)**

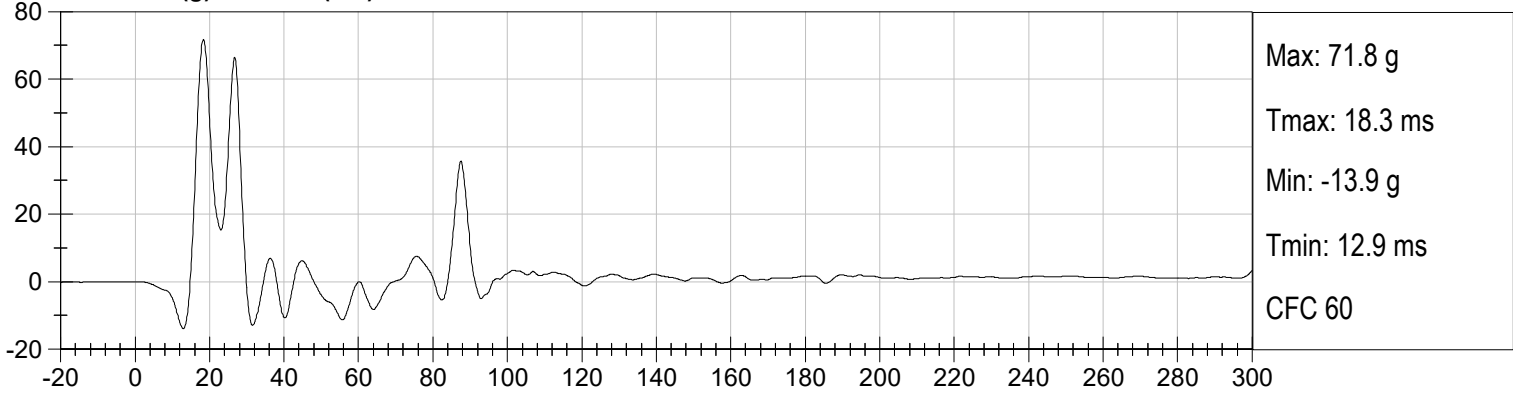

**TRUNK Z Velocity (kph) vs Time (ms)**

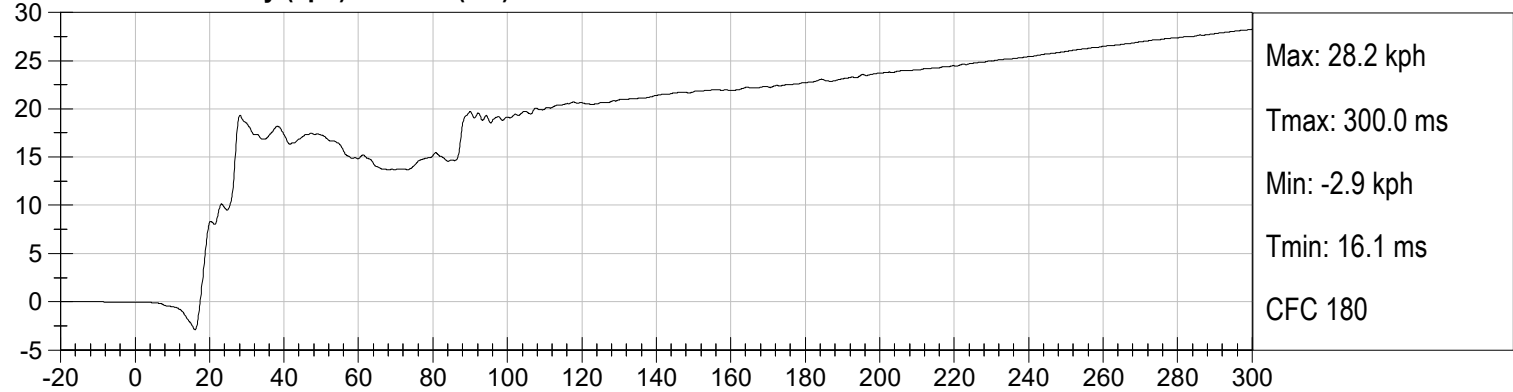

## APPENDIX B

### LOW RISK TEST DATA

#### TABLE OF DATA PLOTS

		<u>Page No.</u>
Figure No. 1.	5 <sup>th</sup> Fem. P1 Driver Head X Acceleration vs. Time	B-1
Figure No. 2.	5 <sup>th</sup> Fem. P1 Driver Head Y Acceleration vs. Time	B-1
Figure No. 3.	5 <sup>th</sup> Fem. P1 Driver Head Z Acceleration vs. Time	B-1
Figure No. 4.	5 <sup>th</sup> Fem. P1 Driver Head Resultant Acceleration vs. Time	B-1
Figure No. 5.	5 <sup>th</sup> Fem. P1 Driver Head X Velocity vs. Time	B-2
Figure No. 6.	5 <sup>th</sup> Fem. P1 Driver Head Y Velocity vs. Time	B-2
Figure No. 7.	5 <sup>th</sup> Fem. P1 Driver Head Z Velocity vs. Time	B-2
Figure No. 8.	5 <sup>th</sup> Fem. P1 Driver Neck Force X vs. Time	B-3
Figure No. 9.	5 <sup>th</sup> Fem. P1 Driver Neck Force Y vs. Time	B-3
Figure No. 10.	5 <sup>th</sup> Fem. P1 Driver Neck Force Z vs. Time	B-3
Figure No. 11.	5 <sup>th</sup> Fem. P1 Driver Neck Force Resultant vs. Time	B-3
Figure No. 12.	5 <sup>th</sup> Fem. P1 Driver Neck Moment X vs. Time	B-4
Figure No. 13.	5 <sup>th</sup> Fem. P1 Driver Neck Moment Y vs. Time	B-4
Figure No. 14.	5 <sup>th</sup> Fem. P1 Driver Neck Moment Z vs. Time	B-4
Figure No. 15.	5 <sup>th</sup> Fem. P1 Driver Occipital Condyle Moment vs. Time	B-4
Figure No. 16.	5 <sup>th</sup> Fem. P1 Driver Chest X Acceleration vs. Time	B-5
Figure No. 17.	5 <sup>th</sup> Fem. P1 Driver Chest Y Acceleration vs. Time	B-5
Figure No. 18.	5 <sup>th</sup> Fem. P1 Driver Chest Z Acceleration vs. Time	B-5
Figure No. 19.	5 <sup>th</sup> Fem. P1 Driver Chest Resultant Acceleration vs. Time	B-5
Figure No. 20.	5 <sup>th</sup> Fem. P1 Driver Chest X Velocity vs. Time	B-6
Figure No. 21.	5 <sup>th</sup> Fem. P1 Driver Chest Y Velocity vs. Time	B-6
Figure No. 22.	5 <sup>th</sup> Fem. P1 Driver Chest Z Velocity vs. Time	B-6
Figure No. 23.	5 <sup>th</sup> Fem. P1 Driver Chest Displacement vs. Time	B-6
Figure No. 24.	5 <sup>th</sup> Fem. P1 Driver Left Femur Force vs. Time	B-7
Figure No. 25.	5 <sup>th</sup> Fem. P1 Driver Right Femur Force vs. Time	B-7
Figure No. 26.	Fire Voltage #1 vs. Time	B-8
Figure No. 27.	Fire Current #1 vs. Time	B-8
Figure No. 28.	Fire Voltage #2 vs. Time	B-8
Figure No. 29.	Fire Current #2 vs. Time	B-8
Figure No. 30.	5 <sup>th</sup> Fem. P1 Driver Nij ( $N_{TF}$ ) vs. Time	B-9

	<u>Page No.</u>
Figure No. 31. 5 <sup>th</sup> Fem. P1 Driver Nij ( $N_{TE}$ ) vs. Time	B-9
Figure No. 32. 5 <sup>th</sup> Fem. P1 Driver Nij ( $N_{CF}$ ) vs. Time	B-9
Figure No. 33. 5 <sup>th</sup> Fem. P1 Driver Nij ( $N_{CE}$ ) vs. Time	B-9
Figure No. 34. 5 <sup>th</sup> Fem. P2 Driver Head X Acceleration vs. Time	B-10
Figure No. 35. 5 <sup>th</sup> Fem. P2 Driver Head Y Acceleration vs. Time	B-10
Figure No. 36. 5 <sup>th</sup> Fem. P2 Driver Head Z Acceleration vs. Time	B-10
Figure No. 37. 5 <sup>th</sup> Fem. P2 Driver Head Resultant Acceleration vs. Time	B-10
Figure No. 38. 5 <sup>th</sup> Fem. P2 Driver Head X Velocity vs. Time	B-11
Figure No. 39. 5 <sup>th</sup> Fem. P2 Driver Head Y Velocity vs. Time	B-11
Figure No. 40. 5 <sup>th</sup> Fem. P2 Driver Head Z Velocity vs. Time	B-11
Figure No. 41. 5 <sup>th</sup> Fem. P2 Driver Neck Force X vs. Time	B-12
Figure No. 42. 5 <sup>th</sup> Fem. P2 Driver Neck Force Y vs. Time	B-12
Figure No. 43. 5 <sup>th</sup> Fem. P2 Driver Neck Force Z vs. Time	B-12
Figure No. 44. 5 <sup>th</sup> Fem. P2 Driver Neck Force Resultant vs. Time	B-12
Figure No. 45. 5 <sup>th</sup> Fem. P2 Driver Neck Moment X vs. Time	B-13
Figure No. 46. 5 <sup>th</sup> Fem. P2 Driver Neck Moment Y vs. Time	B-13
Figure No. 47. 5 <sup>th</sup> Fem. P2 Driver Neck Moment Z vs. Time	B-13
Figure No. 48. 5 <sup>th</sup> Fem. P2 Driver Occipital Condyle Moment vs. Time	B-13
Figure No. 49. 5 <sup>th</sup> Fem. P2 Driver Chest X Acceleration vs. Time	B-14
Figure No. 50. 5 <sup>th</sup> Fem. P2 Driver Chest Y Acceleration vs. Time	B-14
Figure No. 51. 5 <sup>th</sup> Fem. P2 Driver Chest Z Acceleration vs. Time	B-14
Figure No. 52. 5 <sup>th</sup> Fem. P2 Driver Chest Resultant Acceleration vs. Time	B-14
Figure No. 53. 5 <sup>th</sup> Fem. P2 Driver Chest X Velocity vs. Time	B-15
Figure No. 54. 5 <sup>th</sup> Fem. P2 Driver Chest Y Velocity vs. Time	B-15
Figure No. 55. 5 <sup>th</sup> Fem. P2 Driver Chest Z Velocity vs. Time	B-15
Figure No. 56. 5 <sup>th</sup> Fem. P2 Driver Chest Displacement vs. Time	B-15
Figure No. 57. 5 <sup>th</sup> Fem. P2 Driver Left Femur Force vs. Time	B-16
Figure No. 58. 5 <sup>th</sup> Fem. P2 Driver Right Femur Force vs. Time	B-16
Figure No. 59. Fire Voltage #1 vs. Time	B-17
Figure No. 60. Fire Current #1 vs. Time	B-17
Figure No. 61. Fire Voltage #2 vs. Time	B-17
Figure No. 62. Fire Current #2 vs. Time	B-17
Figure No. 63. 5 <sup>th</sup> Fem. P2 Driver Nij ( $N_{TF}$ ) vs. Time	B-18
Figure No. 64. 5 <sup>th</sup> Fem. P2 Driver Nij ( $N_{TE}$ ) vs. Time	B-18
Figure No. 65. 5 <sup>th</sup> Fem. P2 Driver Nij ( $N_{CF}$ ) vs. Time	B-18

	<u>Page No.</u>	
Figure No. 66.	5 <sup>th</sup> Fem. P2 Driver Nij ( $N_{CE}$ ) vs. Time	B-18
Figure No. 67.	3YO P1 Passenger Head X Acceleration vs. Time	B-19
Figure No. 68.	3YO P1 Passenger Head Y Acceleration vs. Time	B-19
Figure No. 69.	3YO P1 Passenger Head Z Acceleration vs. Time	B-19
Figure No. 70.	3YO P1 Passenger Head Resultant Acceleration vs. Time	B-19
Figure No. 71.	3YO P1 Passenger Head X Velocity vs. Time	B-20
Figure No. 72.	3YO P1 Passenger Head Y Velocity vs. Time	B-20
Figure No. 73.	3YO P1 Passenger Head Z Velocity vs. Time	B-20
Figure No. 74.	3YO P1 Passenger Neck Force X vs. Time	B-21
Figure No. 75.	3YO P1 Passenger Neck Force Y vs. Time	B-21
Figure No. 76.	3YO P1 Passenger Neck Force Z vs. Time	B-21
Figure No. 77.	3YO P1 Passenger Neck Force Resultant vs. Time	B-21
Figure No. 78.	3YO P1 Passenger Neck Moment X vs. Time	B-22
Figure No. 79.	3YO P1 Passenger Neck Moment Y vs. Time	B-22
Figure No. 80.	3YO P1 Passenger Neck Moment Z vs. Time	B-22
Figure No. 81.	3YO P1 Passenger Occipital Condyle Moment vs. Time	B-22
Figure No. 82.	3YO P1 Passenger Chest X Acceleration vs. Time	B-23
Figure No. 83.	3YO P1 Passenger Chest Y Acceleration vs. Time	B-23
Figure No. 84.	3YO P1 Passenger Chest Z Acceleration vs. Time	B-23
Figure No. 85.	3YO P1 Passenger Chest Resultant Acceleration vs. Time	B-23
Figure No. 86.	3YO P1 Passenger Chest X Velocity vs. Time	B-24
Figure No. 87.	3YO P1 Passenger Chest Y Velocity vs. Time	B-24
Figure No. 88.	3YO P1 Passenger Chest Z Velocity vs. Time	B-24
Figure No. 89.	3YO P1 Passenger Chest Displacement vs. Time	B-24
Figure No. 90.	Fire Voltage #1 vs. Time	B-25
Figure No. 91.	Fire Current #1 vs. Time	B-25
Figure No. 92.	Fire Voltage #2 vs. Time	B-25
Figure No. 93.	Fire Current #2 vs. Time	B-25
Figure No. 94.	Active Vent Voltage vs. Time	B-26
Figure No. 95.	Active Vent Current vs. Time	B-26
Figure No. 96.	3YO P1 Passenger Nij ( $N_{TF}$ ) vs. Time	B-27
Figure No. 97.	3YO P1 Passenger Nij ( $N_{TE}$ ) vs. Time	B-27
Figure No. 98.	3YO P1 Passenger Nij ( $N_{CF}$ ) vs. Time	B-27
Figure No. 99.	3YO P1 Passenger Nij ( $N_{CE}$ ) vs. Time	B-27
Figure No. 100.	3YO P2 Passenger Head X Acceleration vs. Time	B-28

	<u>Page No.</u>
Figure No. 101. 3YO P2 Passenger Head Y Acceleration vs. Time	B-28
Figure No. 102. 3YO P2 Passenger Head Z Acceleration vs. Time	B-28
Figure No. 103. 3YO P2 Passenger Head Resultant Acceleration vs. Time	B-28
Figure No. 104. 3YO P2 Passenger Head X Velocity vs. Time	B-29
Figure No. 105. 3YO P2 Passenger Head Y Velocity vs. Time	B-29
Figure No. 106. 3YO P2 Passenger Head Z Velocity vs. Time	B-29
Figure No. 107. 3YO P2 Passenger Neck Force X vs. Time	B-30
Figure No. 108. 3YO P2 Passenger Neck Force Y vs. Time	B-30
Figure No. 109. 3YO P2 Passenger Neck Force Z vs. Time	B-30
Figure No. 110. 3YO P2 Passenger Neck Force Resultant vs. Time	B-30
Figure No. 111. 3YO P2 Passenger Neck Moment X vs. Time	B-31
Figure No. 112. 3YO P2 Passenger Neck Moment Y vs. Time	B-31
Figure No. 113. 3YO P2 Passenger Neck Moment Z vs. Time	B-31
Figure No. 114. 3YO P2 Passenger Occipital Condyle Moment vs. Time	B-31
Figure No. 115. 3YO P2 Passenger Chest X Acceleration vs. Time	B-32
Figure No. 116. 3YO P2 Passenger Chest Y Acceleration vs. Time	B-32
Figure No. 117. 3YO P2 Passenger Chest Z Acceleration vs. Time	B-32
Figure No. 118. 3YO P2 Passenger Chest Resultant Acceleration vs. Time	B-32
Figure No. 119. 3YO P2 Passenger Chest X Velocity vs. Time	B-33
Figure No. 120. 3YO P2 Passenger Chest Y Velocity vs. Time	B-33
Figure No. 121. 3YO P2 Passenger Chest Z Velocity vs. Time	B-33
Figure No. 122. 3YO P2 Passenger Chest Displacement vs. Time	B-33
Figure No. 123. Fire Voltage #1 vs. Time	B-34
Figure No. 124. Fire Current #1 vs. Time	B-34
Figure No. 125. Fire Voltage #2 vs. Time	B-34
Figure No. 126. Fire Current #2 vs. Time	B-34
Figure No. 127. Active Vent Voltage vs. Time	B-35
Figure No. 128. Active Vent Current vs. Time	B-35
Figure No. 129. 3YO P2 Passenger Nij ( $N_{TF}$ ) vs. Time	B-36
Figure No. 130. 3YO P2 Passenger Nij ( $N_{TE}$ ) vs. Time	B-36
Figure No. 131. 3YO P2 Passenger Nij ( $N_{CF}$ ) vs. Time	B-36
Figure No. 132. 3YO P2 Passenger Nij ( $N_{CE}$ ) vs. Time	B-36
Figure No. 133. 6YO P1 Passenger Head X Acceleration vs. Time	B-37
Figure No. 134. 6YO P1 Passenger Head Y Acceleration vs. Time	B-37
Figure No. 135. 6YO P1 Passenger Head Z Acceleration vs. Time	B-37

	<u>Page No.</u>
Figure No. 136. 6YO P1 Passenger Head Resultant Acceleration vs. Time	B-37
Figure No. 137. 6YO P1 Passenger Head X Velocity vs. Time	B-38
Figure No. 138. 6YO P1 Passenger Head Y Velocity vs. Time	B-38
Figure No. 139. 6YO P1 Passenger Head Z Velocity vs. Time	B-38
Figure No. 140. 6YO P1 Passenger Neck Force X vs. Time	B-39
Figure No. 141. 6YO P1 Passenger Neck Force Y vs. Time	B-39
Figure No. 142. 6YO P1 Passenger Neck Force Z vs. Time	B-39
Figure No. 143. 6YO P1 Passenger Neck Force Resultant vs. Time	B-39
Figure No. 144. 6YO P1 Passenger Neck Moment X vs. Time	B-40
Figure No. 145. 6YO P1 Passenger Neck Moment Y vs. Time	B-40
Figure No. 146. 6YO P1 Passenger Neck Moment Z vs. Time	B-40
Figure No. 147. 6YO P1 Passenger Occipital Condyle Moment vs. Time	B-40
Figure No. 148. 6YO P1 Passenger Chest X Acceleration vs. Time	B-41
Figure No. 149. 6YO P1 Passenger Chest Y Acceleration vs. Time	B-41
Figure No. 150. 6YO P1 Passenger Chest Z Acceleration vs. Time	B-41
Figure No. 151. 6YO P1 Passenger Chest Resultant Acceleration vs. Time	B-41
Figure No. 152. 6YO P1 Passenger Chest X Velocity vs. Time	B-42
Figure No. 153. 6YO P1 Passenger Chest Y Velocity vs. Time	B-42
Figure No. 154. 6YO P1 Passenger Chest Z Velocity vs. Time	B-42
Figure No. 155. 6YO P1 Passenger Chest Displacement vs. Time	B-42
Figure No. 156. Fire Voltage #1 vs. Time	B-43
Figure No. 157. Fire Current #1 vs. Time	B-43
Figure No. 158. Fire Voltage #2 vs. Time	B-43
Figure No. 159. Fire Current #2 vs. Time	B-43
Figure No. 160. Active Vent Voltage vs. Time	B-44
Figure No. 161. Active Vent Current vs. Time	B-44
Figure No. 162. 6YO P1 Passenger $N_{ij}$ ( $N_{TF}$ ) vs. Time	B-45
Figure No. 163. 6YO P1 Passenger $N_{ij}$ ( $N_{TE}$ ) vs. Time	B-45
Figure No. 164. 6YO P1 Passenger $N_{ij}$ ( $N_{CF}$ ) vs. Time	B-45
Figure No. 165. 6YO P1 Passenger $N_{ij}$ ( $N_{CE}$ ) vs. Time	B-45
Figure No. 166. 6YO P2 Passenger Head X Acceleration vs. Time	B-46
Figure No. 167. 6YO P2 Passenger Head Y Acceleration vs. Time	B-46
Figure No. 168. 6YO P2 Passenger Head Z Acceleration vs. Time	B-46
Figure No. 169. 6YO P2 Passenger Head Resultant Acceleration vs. Time	B-46
Figure No. 170. 6YO P2 Passenger Head X Velocity vs. Time	B-47

	<u>Page No.</u>
Figure No. 171. 6YO P2 Passenger Head Y Velocity vs. Time	B-47
Figure No. 172. 6YO P2 Passenger Head Z Velocity vs. Time	B-47
Figure No. 173. 6YO P2 Passenger Neck Force X vs. Time	B-48
Figure No. 174. 6YO P2 Passenger Neck Force Y vs. Time	B-48
Figure No. 175. 6YO P2 Passenger Neck Force Z vs. Time	B-48
Figure No. 176. 6YO P2 Passenger Neck Force Resultant vs. Time	B-48
Figure No. 177. 6YO P2 Passenger Neck Moment X vs. Time	B-49
Figure No. 178. 6YO P2 Passenger Neck Moment Y vs. Time	B-49
Figure No. 179. 6YO P2 Passenger Neck Moment Z vs. Time	B-49
Figure No. 180. 6YO P2 Passenger Occipital Condyle Moment vs. Time	B-49
Figure No. 181. 6YO P2 Passenger Chest X Acceleration vs. Time	B-50
Figure No. 182. 6YO P2 Passenger Chest Y Acceleration vs. Time	B-50
Figure No. 183. 6YO P2 Passenger Chest Z Acceleration vs. Time	B-50
Figure No. 184. 6YO P2 Passenger Chest Resultant Acceleration vs. Time	B-50
Figure No. 185. 6YO P2 Passenger Chest X Velocity vs. Time	B-51
Figure No. 186. 6YO P2 Passenger Chest Y Velocity vs. Time	B-51
Figure No. 187. 6YO P2 Passenger Chest Z Velocity vs. Time	B-51
Figure No. 188. 6YO P2 Passenger Chest Displacement vs. Time	B-51
Figure No. 189. Fire Voltage #1 vs. Time	B-52
Figure No. 190. Fire Current #1 vs. Time	B-52
Figure No. 191. Fire Voltage #2 vs. Time	B-52
Figure No. 192. Fire Current #2 vs. Time	B-52
Figure No. 193. Active Vent Voltage vs. Time	B-53
Figure No. 194. Active Vent Current vs. Time	B-53
Figure No. 195. 6YO P2 Passenger Nij ( $N_{TF}$ ) vs. Time	B-54
Figure No. 196. 6YO P2 Passenger Nij ( $N_{TE}$ ) vs. Time	B-54
Figure No. 197. 6YO P2 Passenger Nij ( $N_{CF}$ ) vs. Time	B-54
Figure No. 198. 6YO P2 Passenger Nij ( $N_{CE}$ ) vs. Time	B-54

Injury Values Calculated between 0ms and 300ms

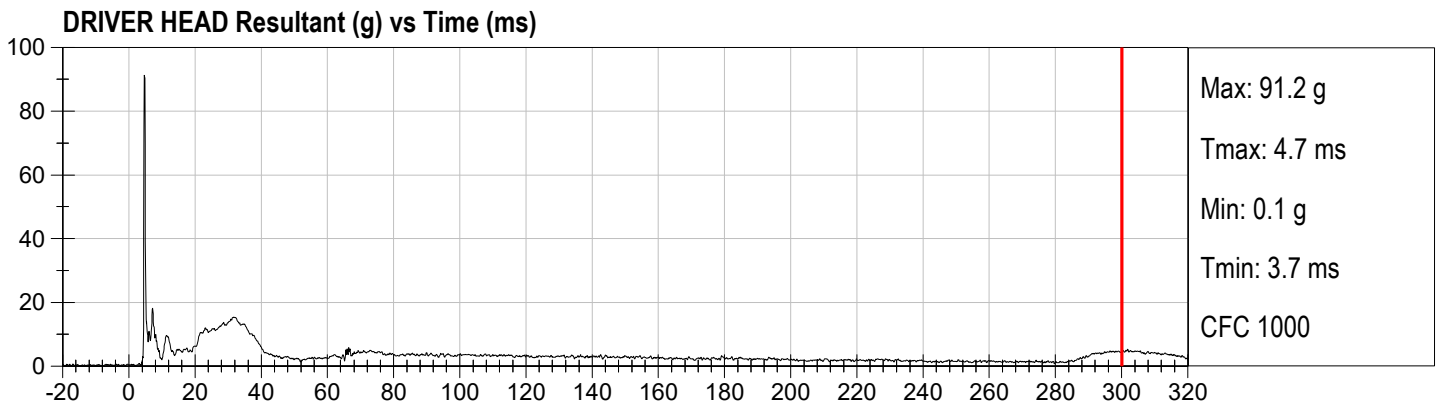
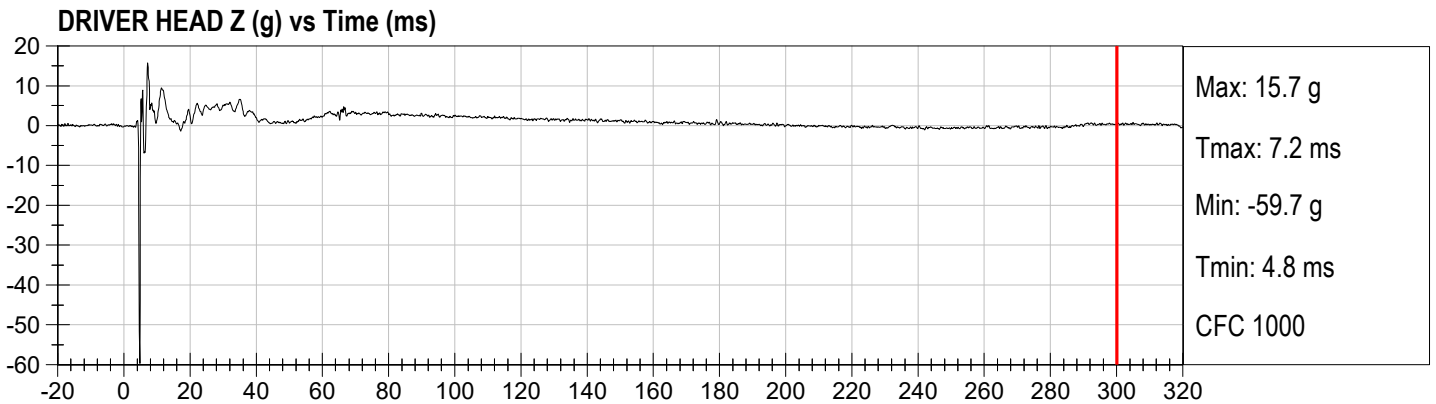
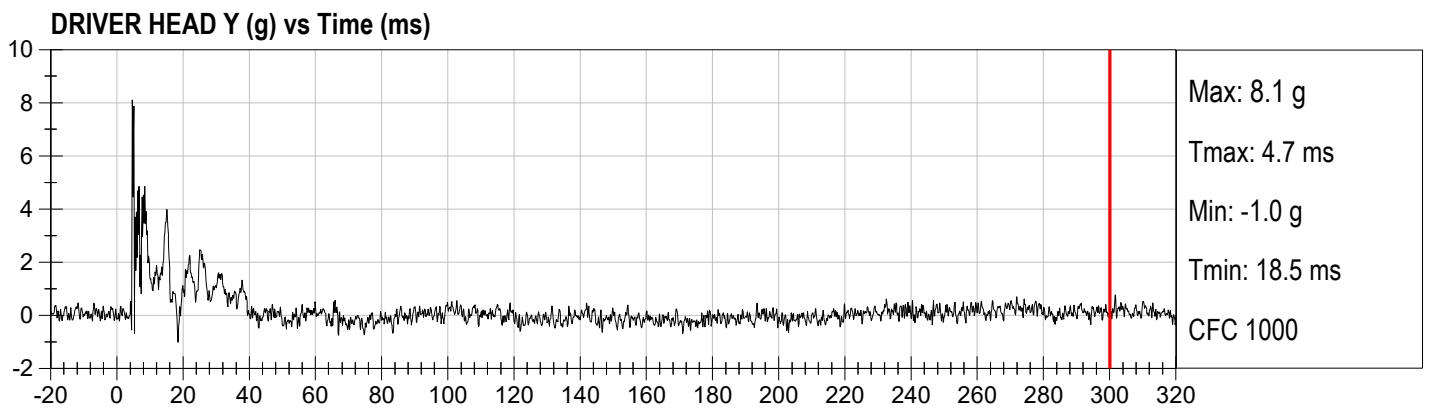
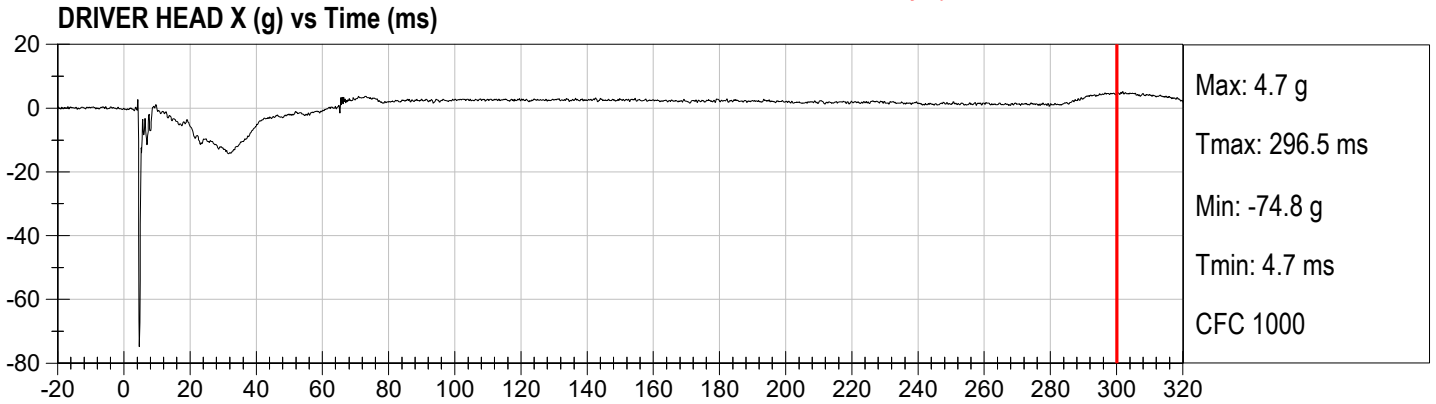

Injury Values Calculated between 0ms and 300ms

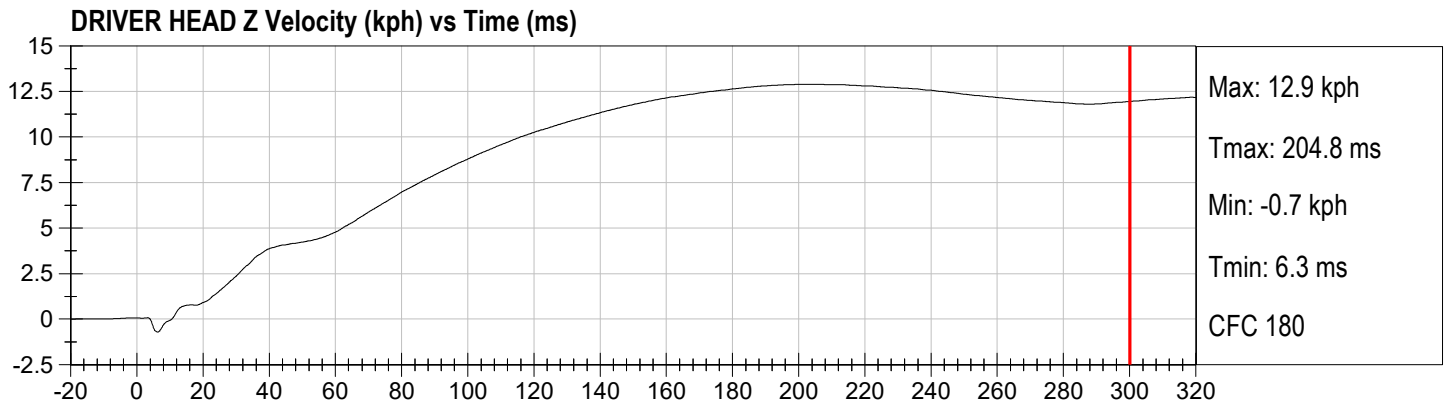
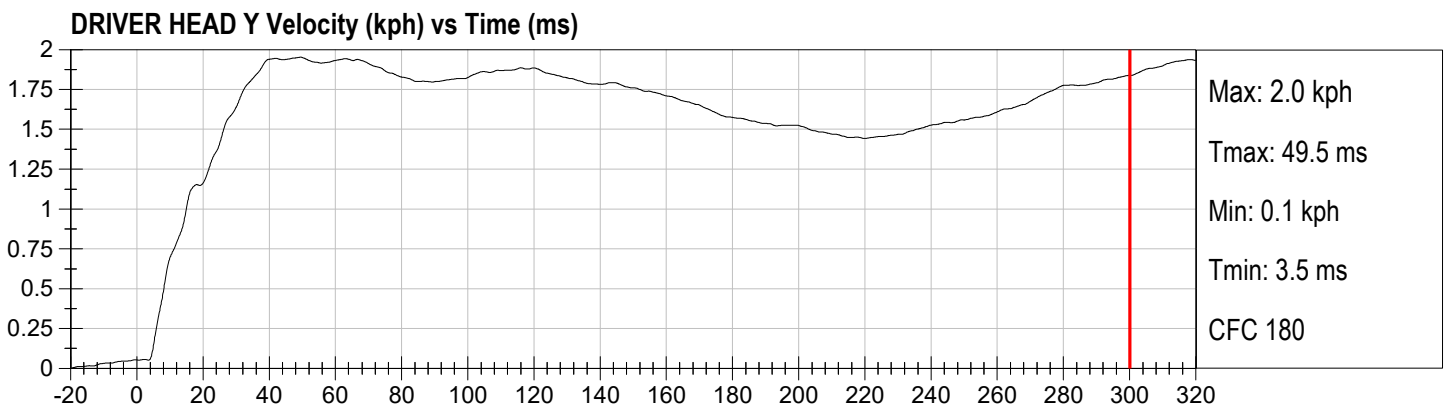
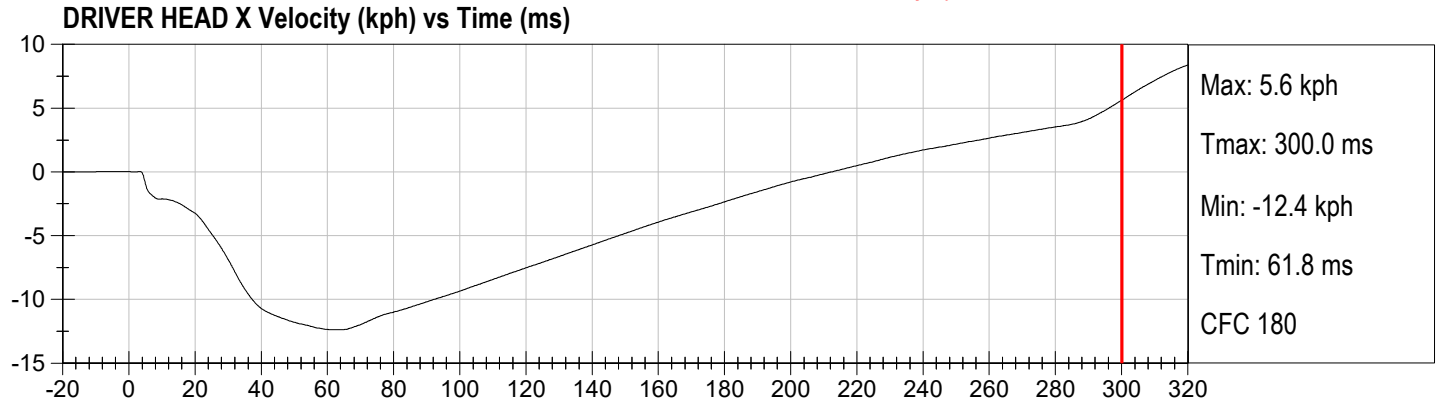

Injury Values Calculated between 0ms and 300ms

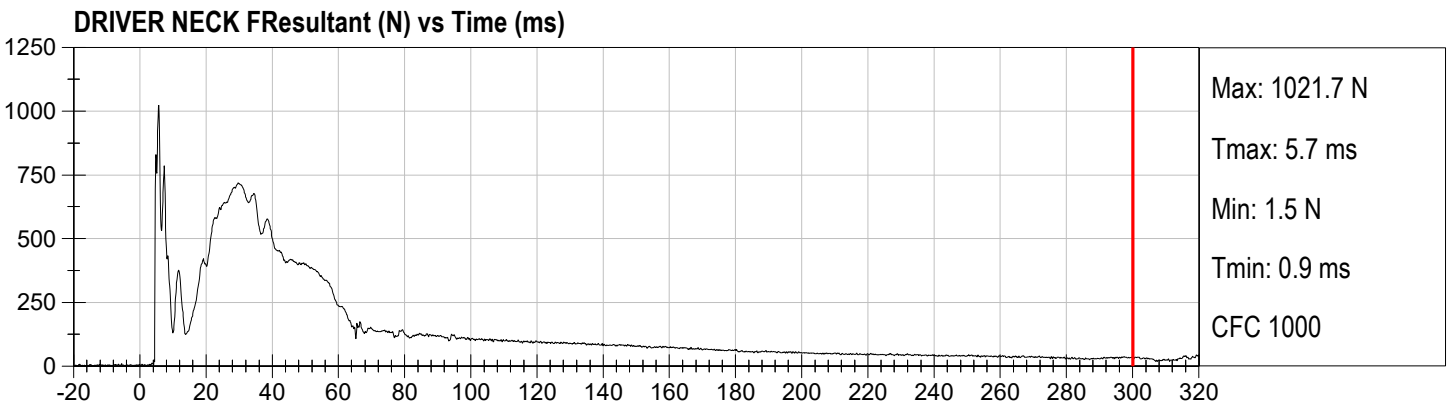
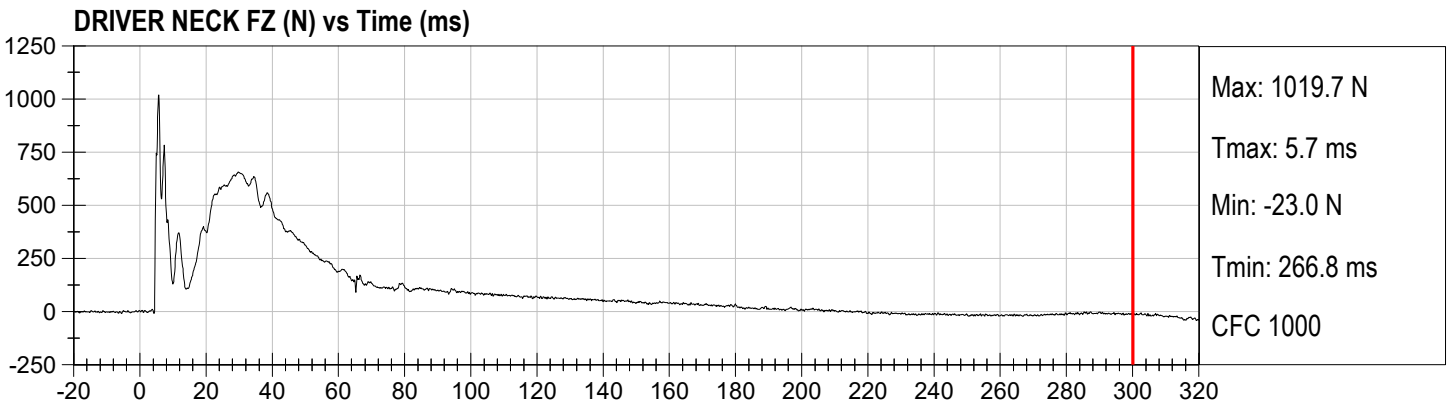
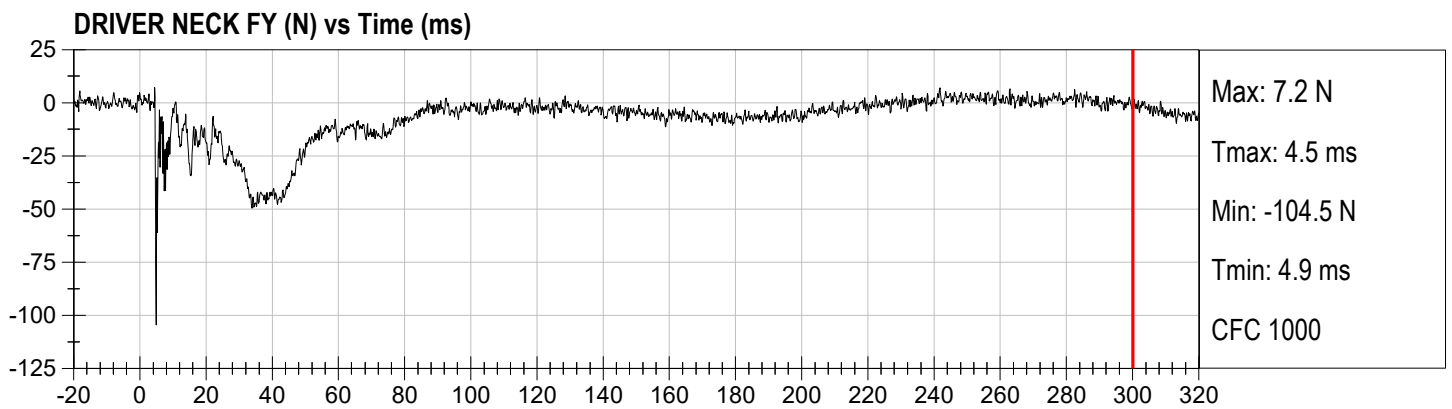
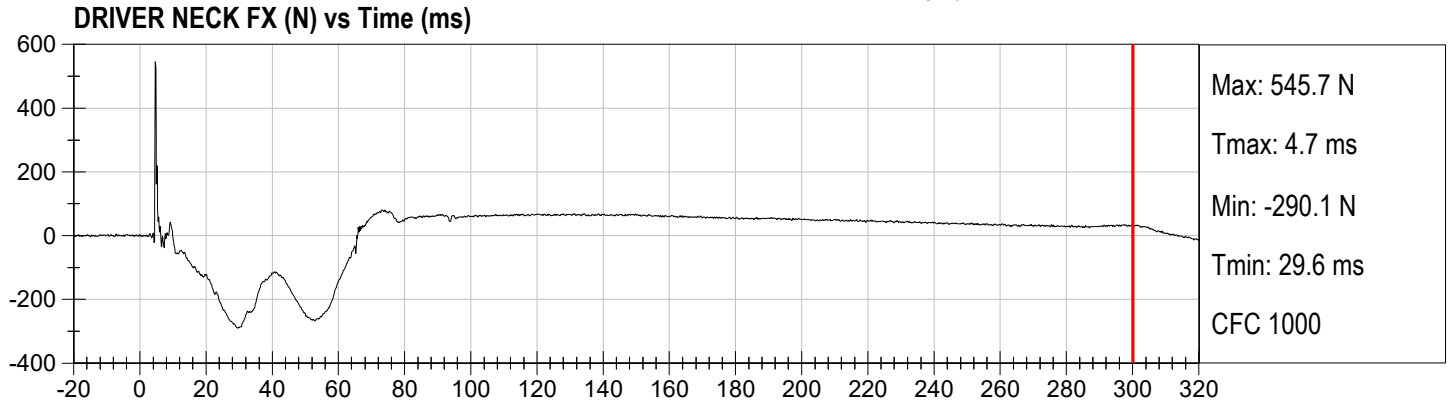

Injury Values Calculated between 0ms and 300ms

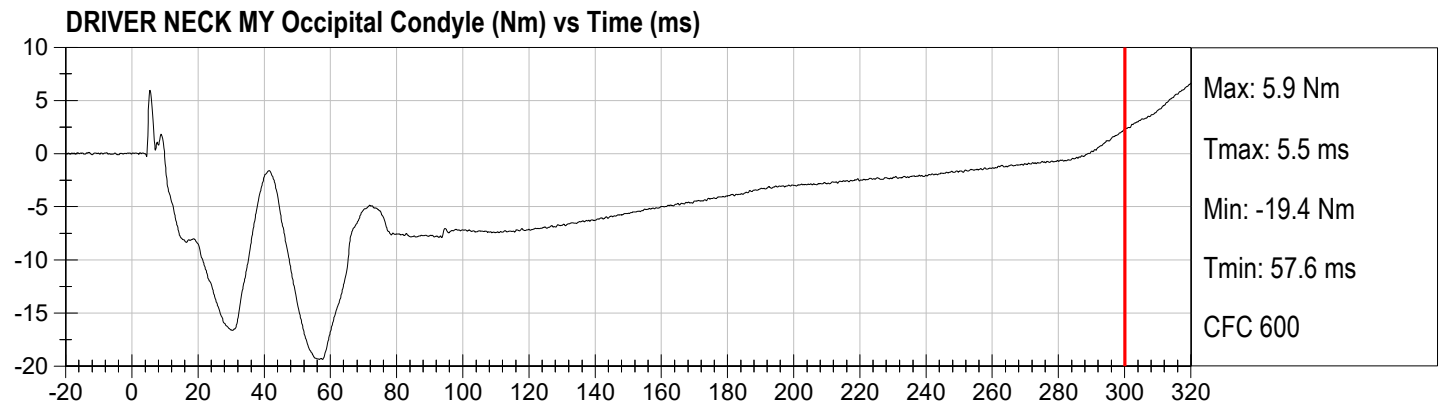
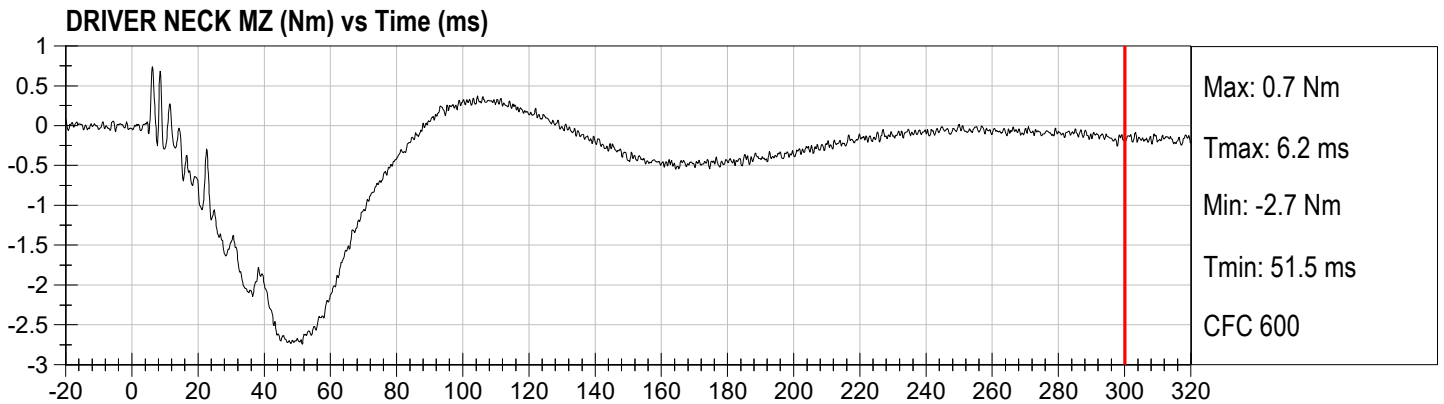
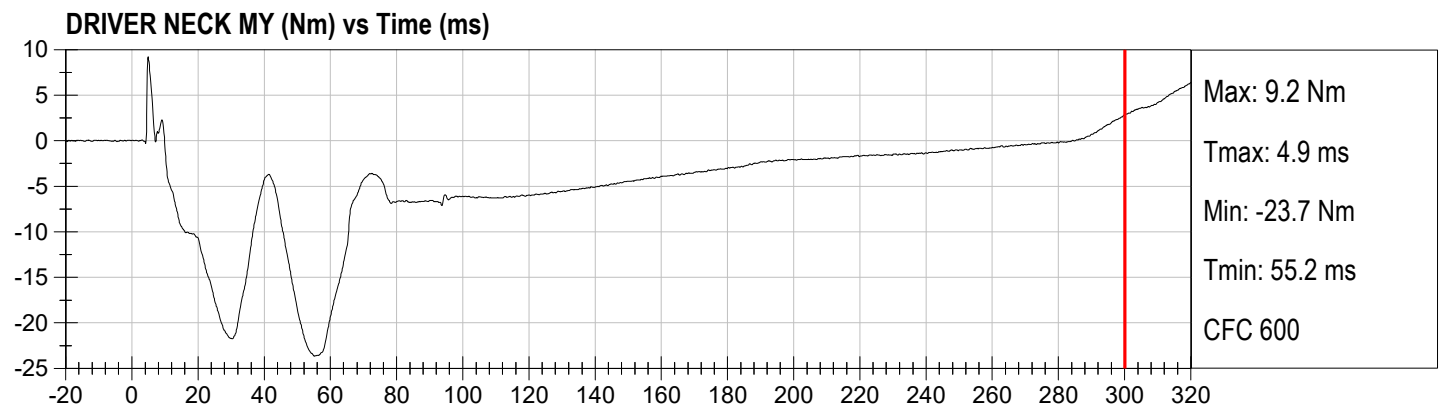
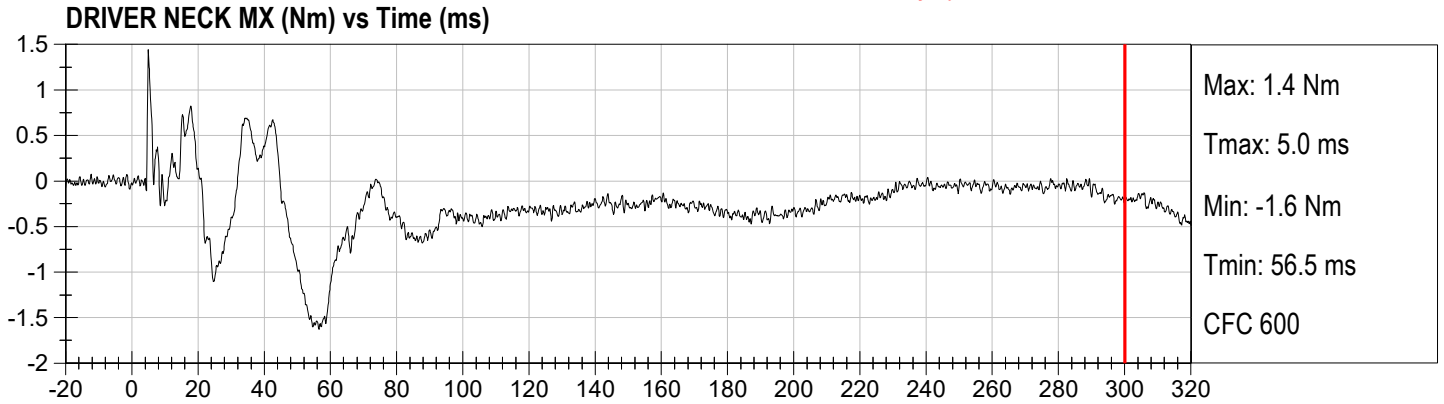

Injury Values Calculated between 0ms and 300ms

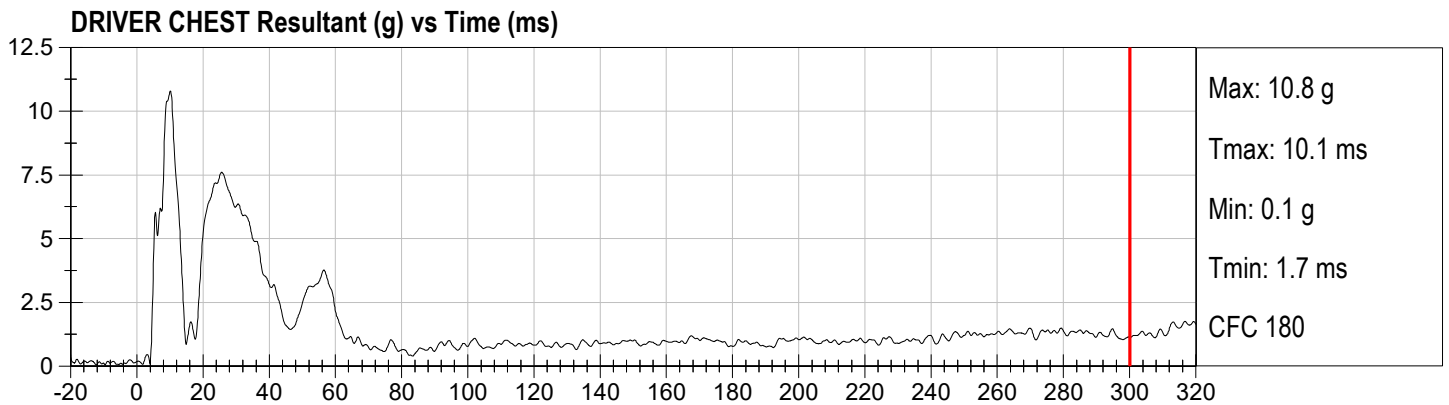
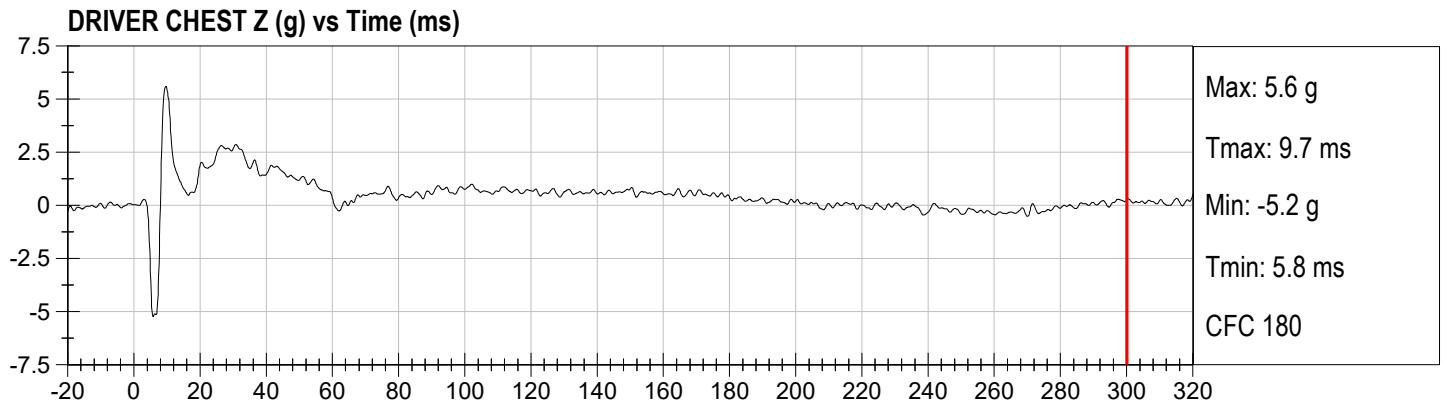
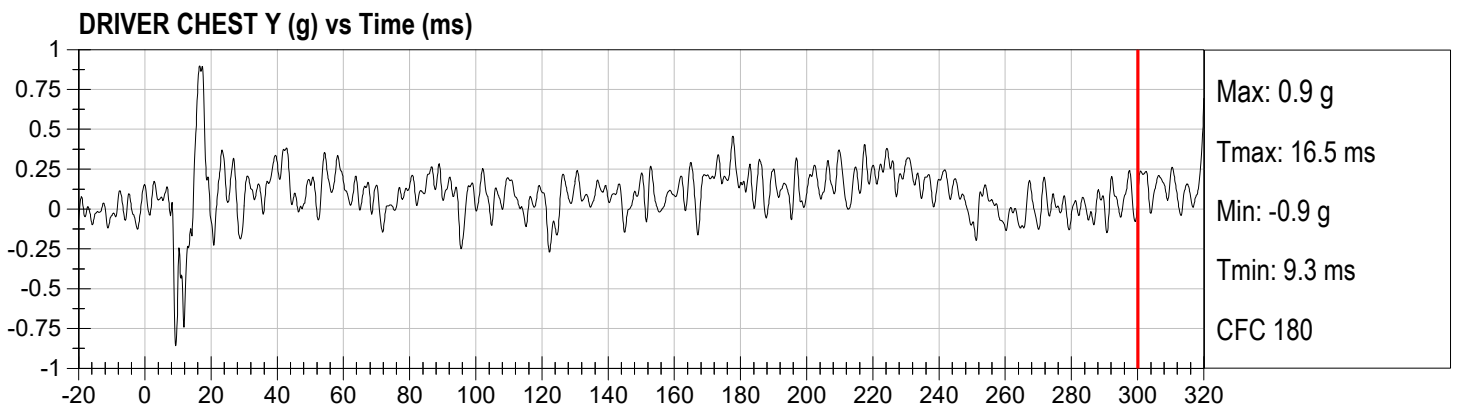
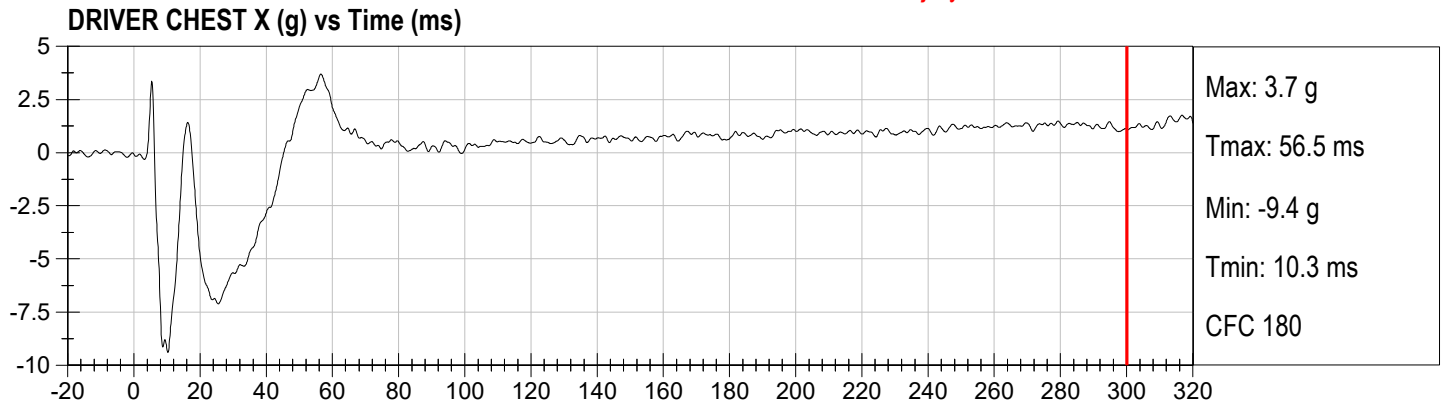

Injury Values Calculated between 0ms and 300ms

**DRIVER CHEST X Velocity (kph) vs Time (ms)**

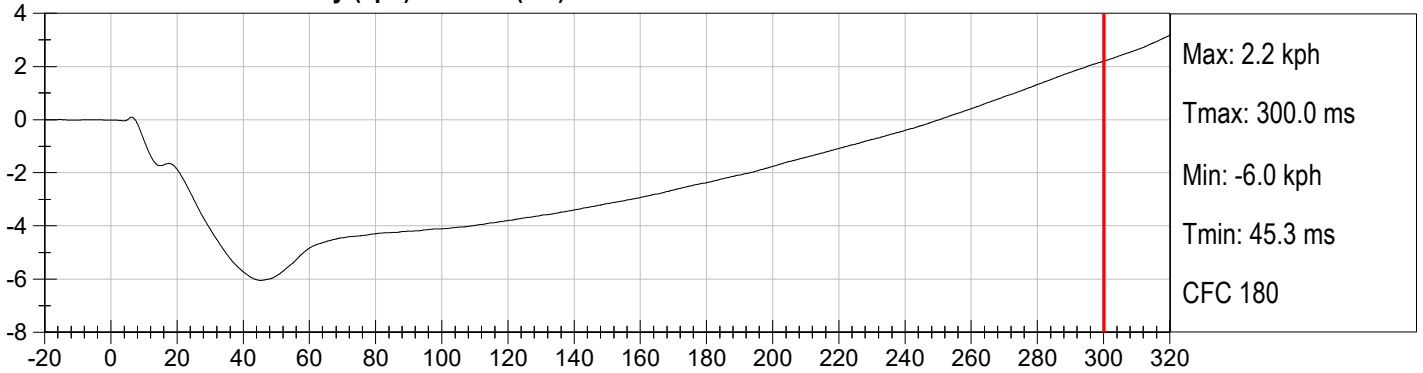

**DRIVER CHEST Y Velocity (kph) vs Time (ms)**

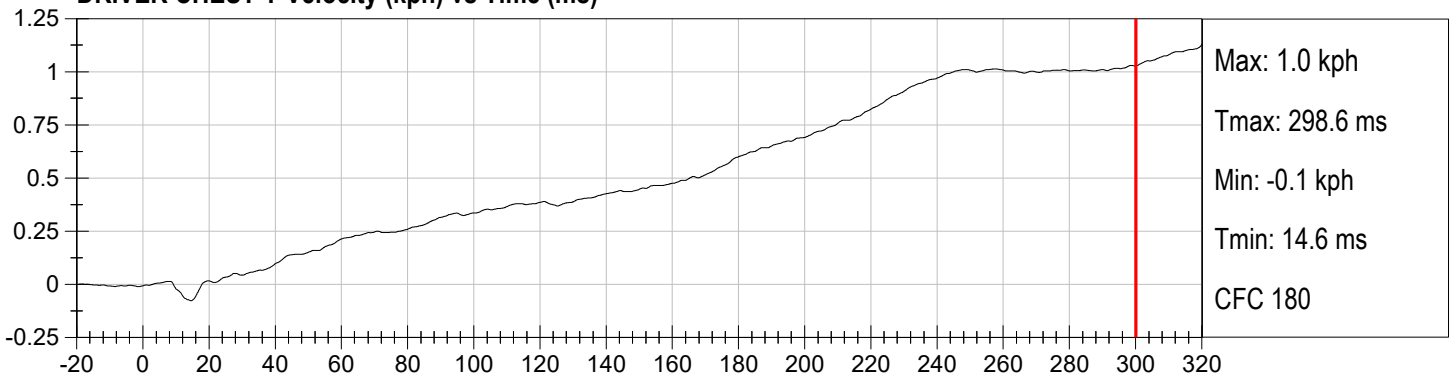

**DRIVER CHEST Z Velocity (kph) vs Time (ms)**

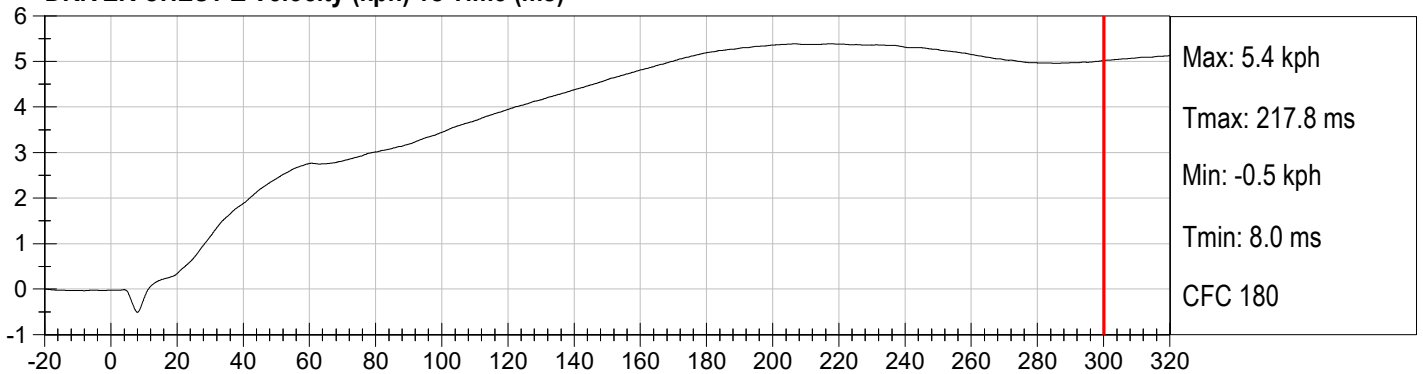

**DRIVER CHEST DISPLACEMENT (mm) vs Time (ms)**

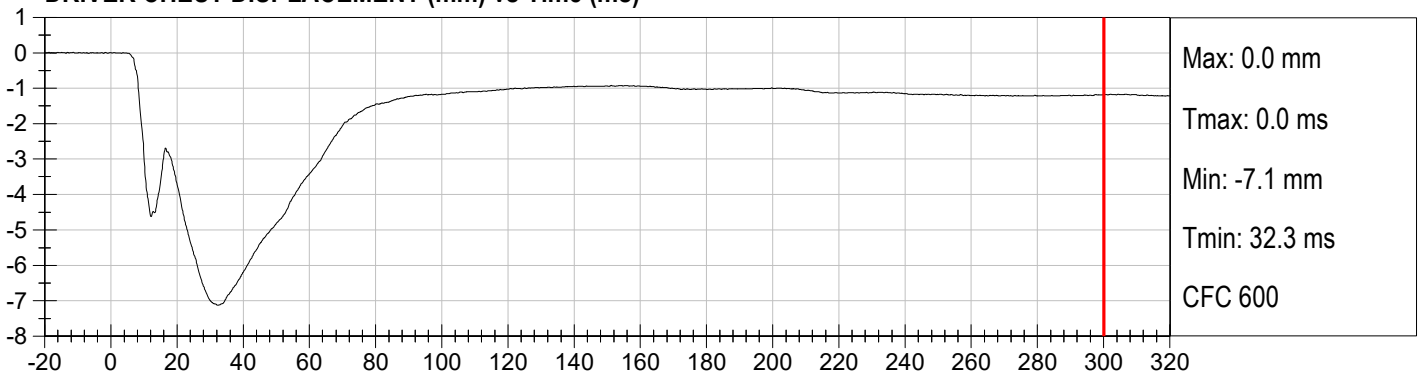

Injury Values Calculated between 0ms and 300ms

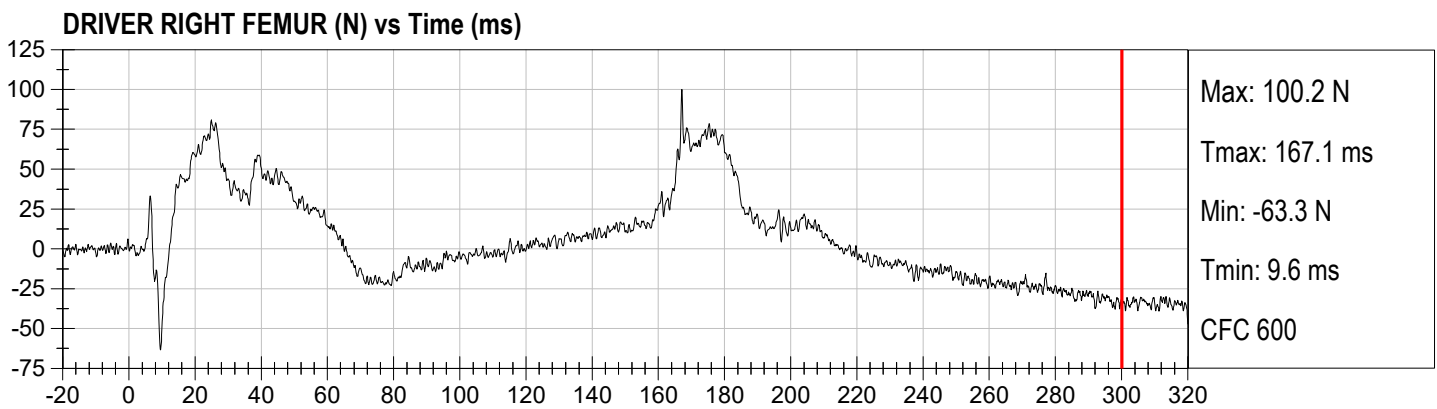
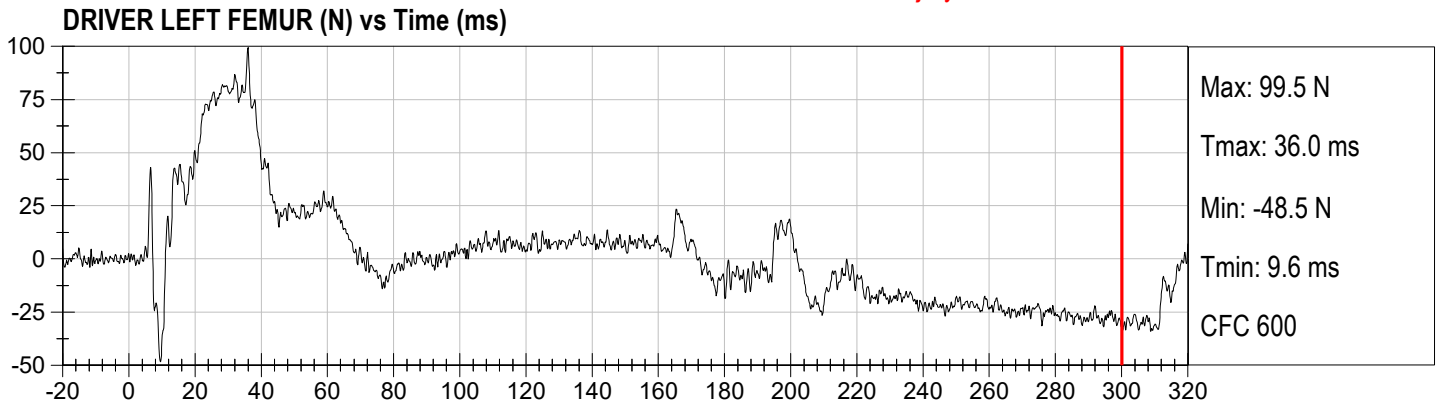

Injury Values Calculated between 0ms and 300ms

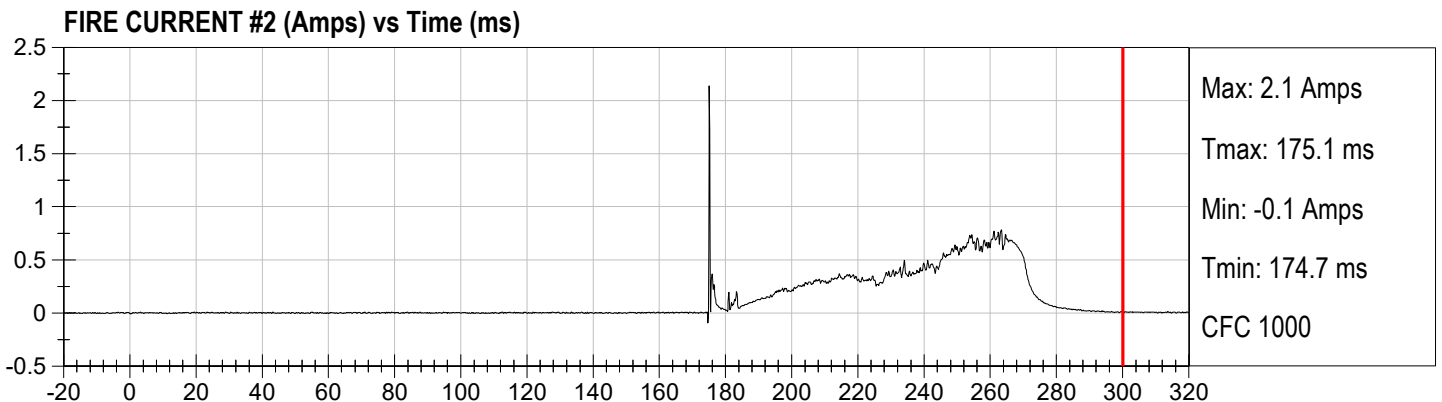
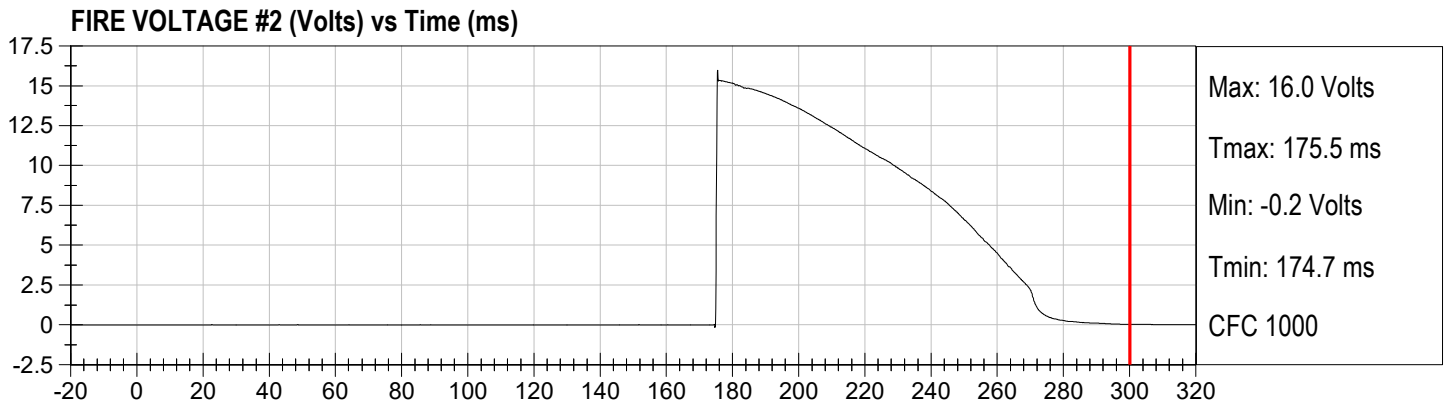
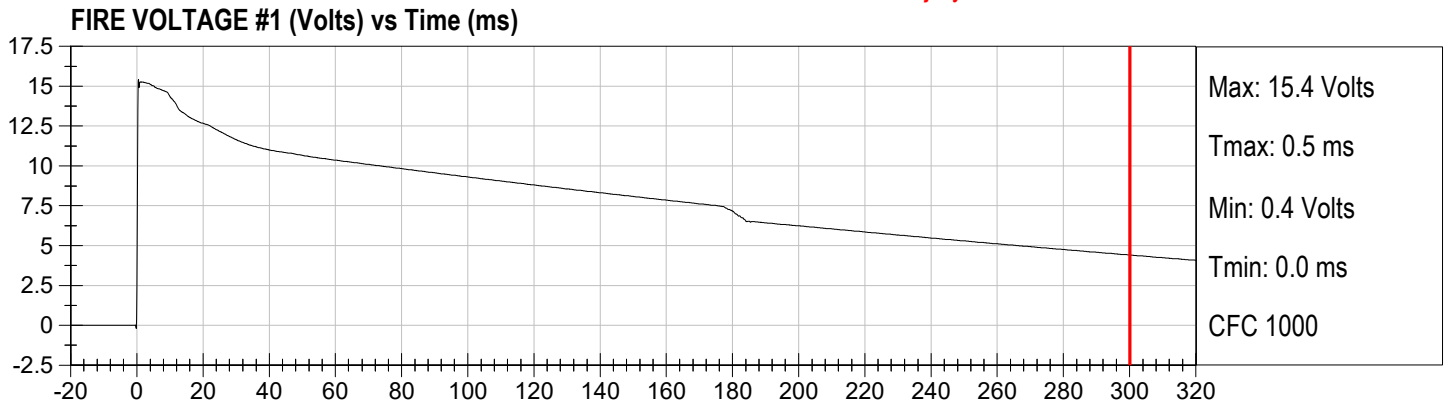

Injury Values Calculated between 0ms and 300ms

DRIVER Nij (NTF) vs Time (ms)

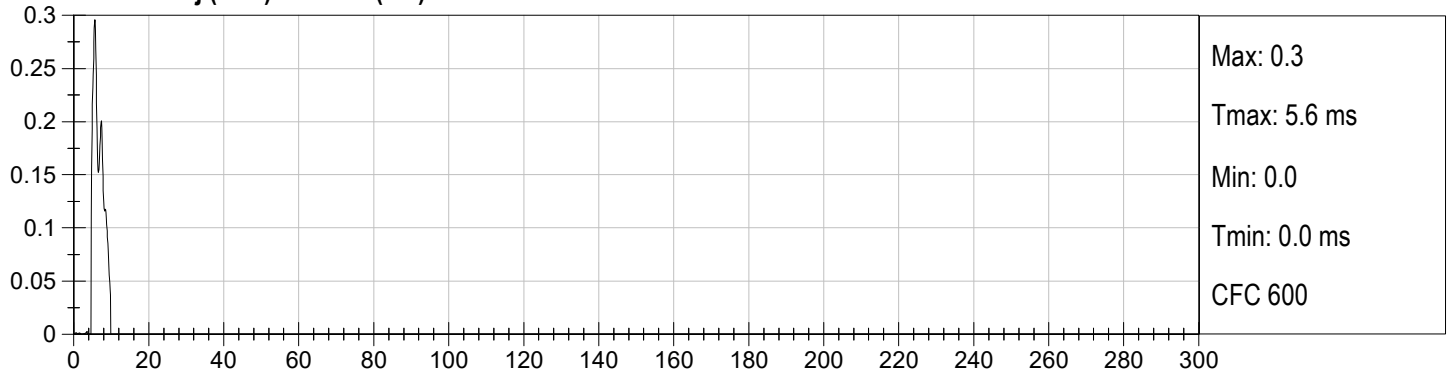

DRIVER Nij (NTE) vs Time (ms)

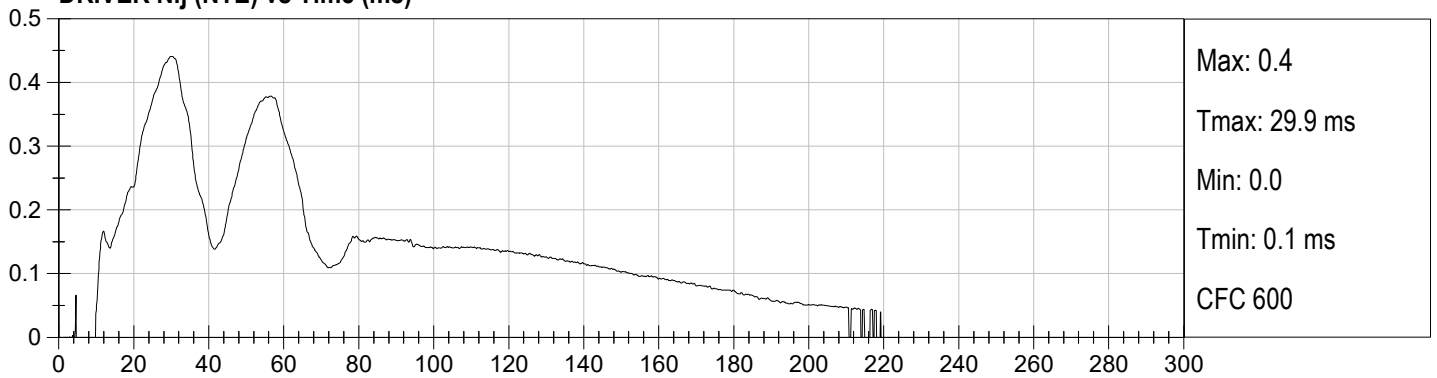

DRIVER Nij (NCF) vs Time (ms)

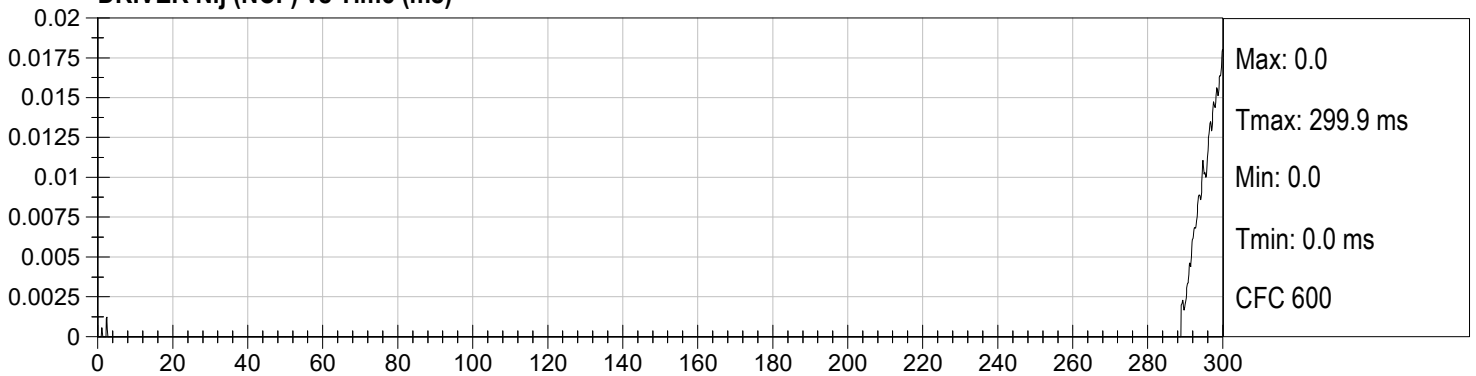

DRIVER Nij (NCE) vs Time (ms)

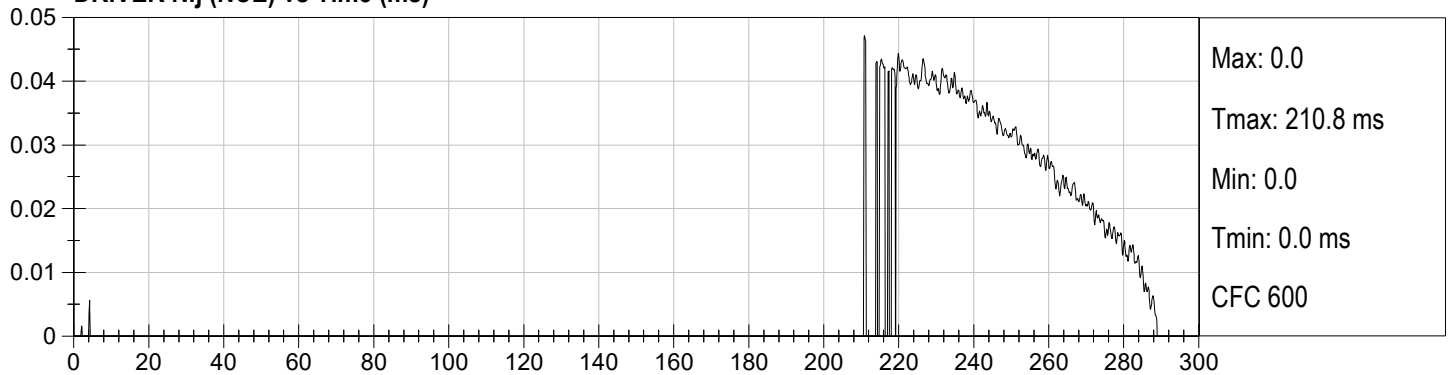

Injury Values Calculated between 0ms and 300ms

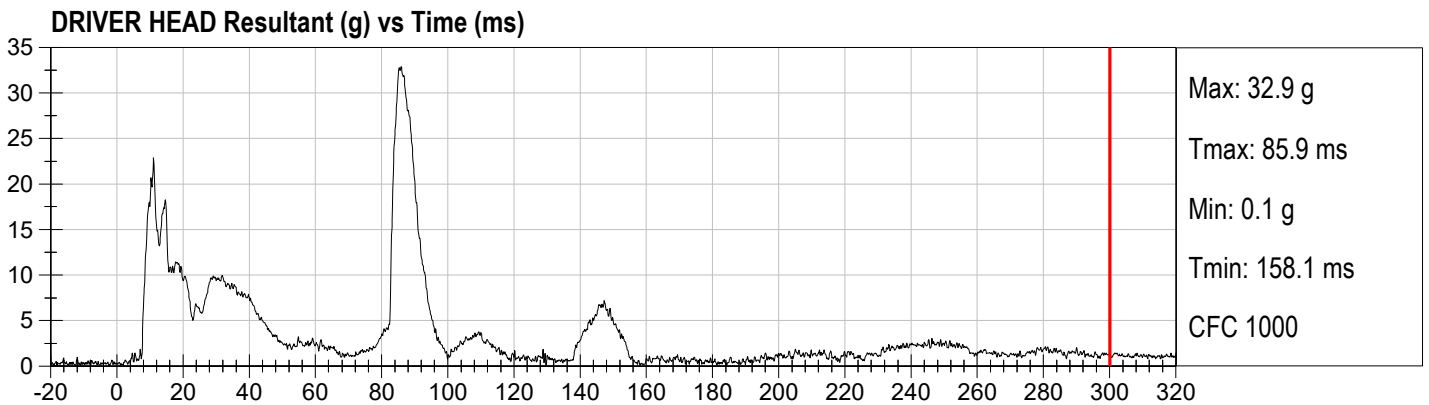
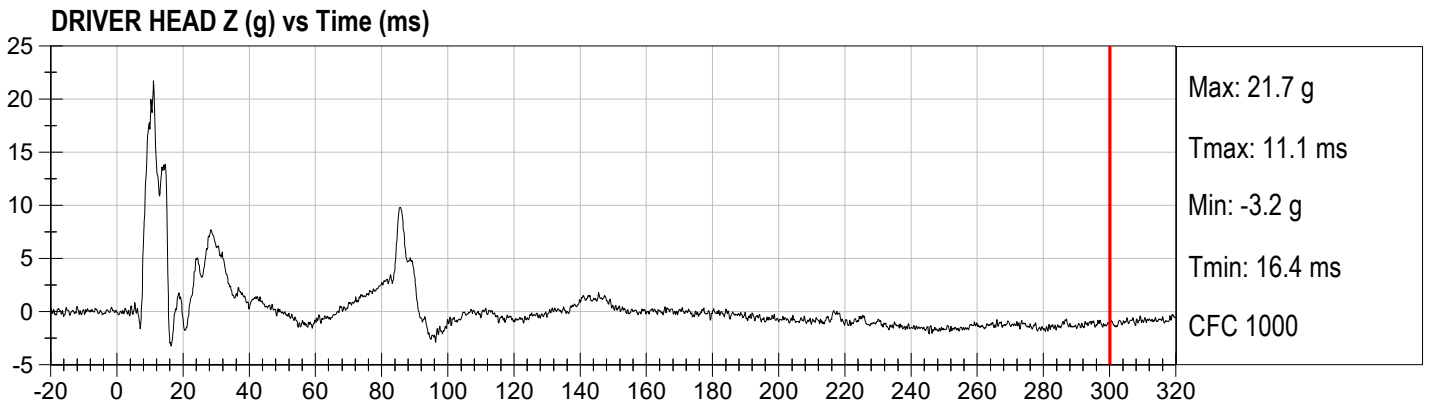
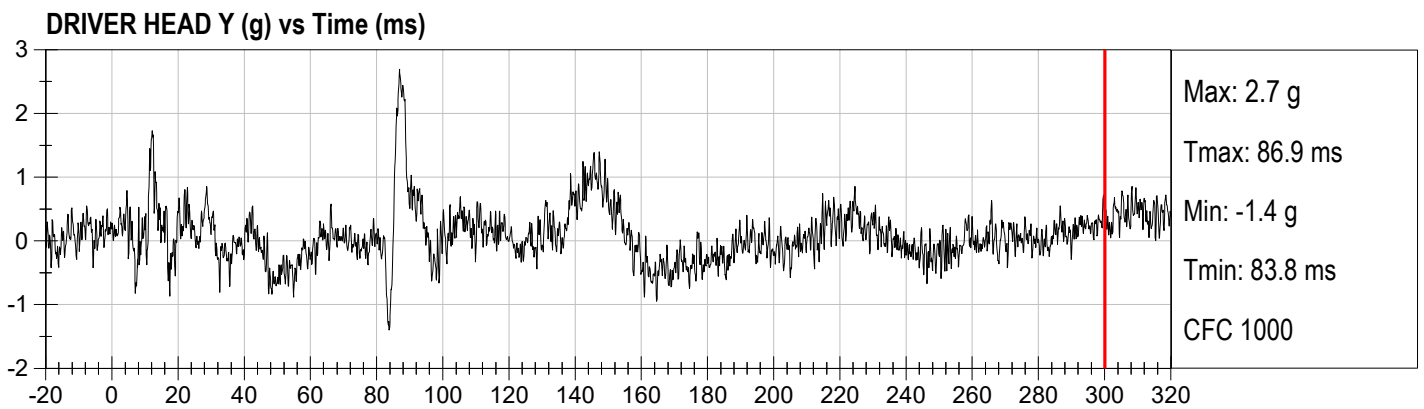
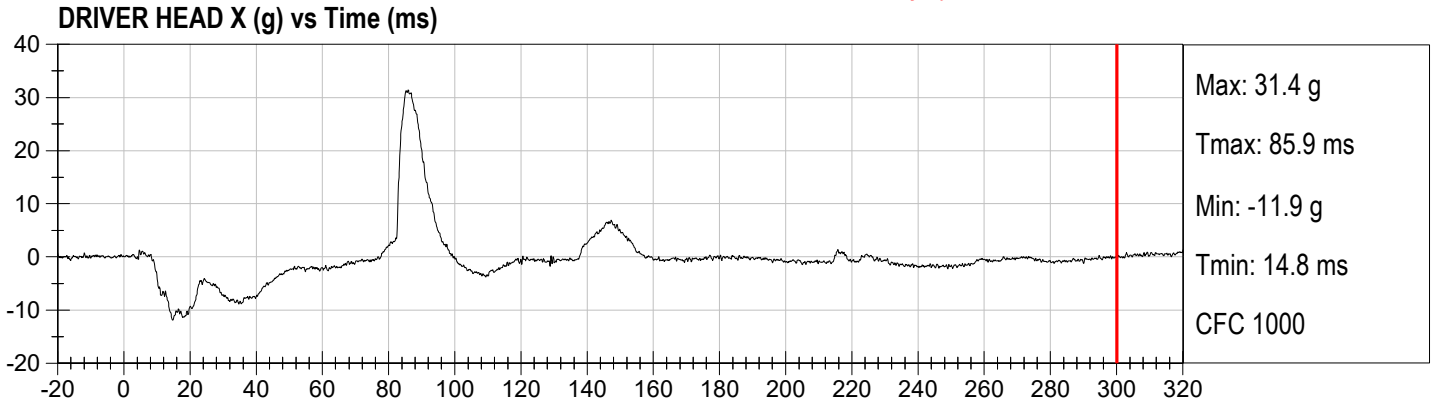

Injury Values Calculated between 0ms and 300ms

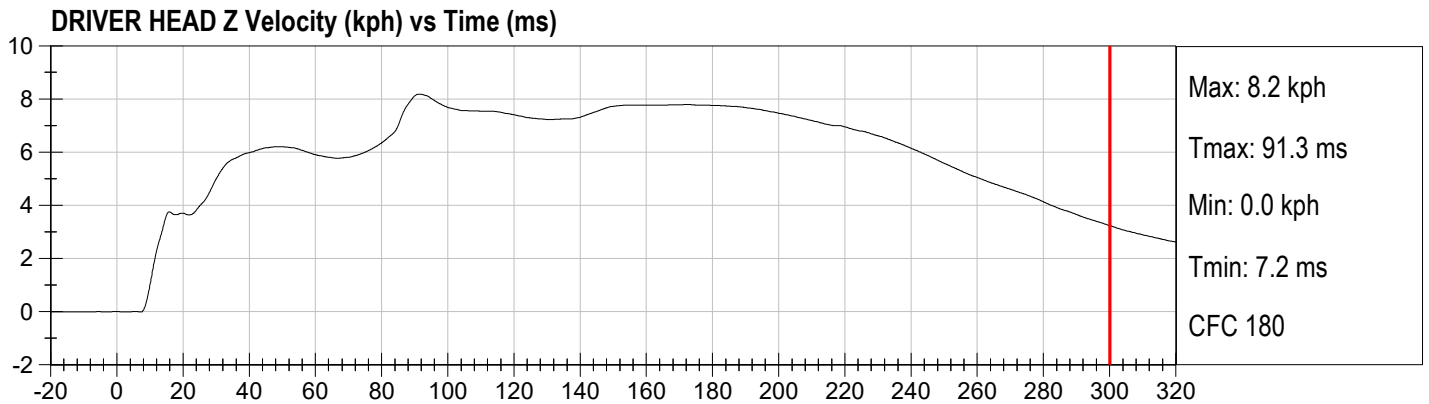
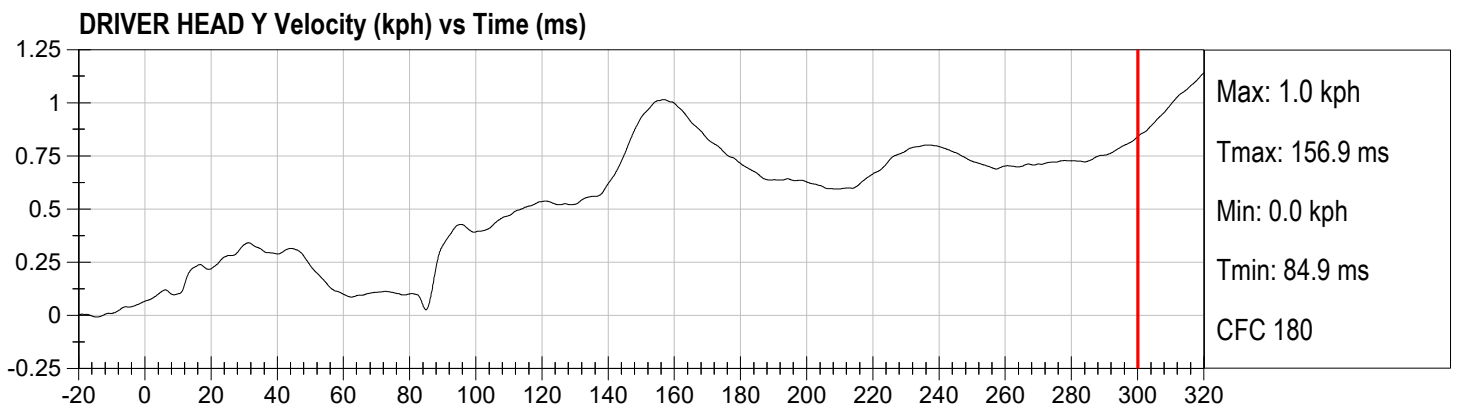
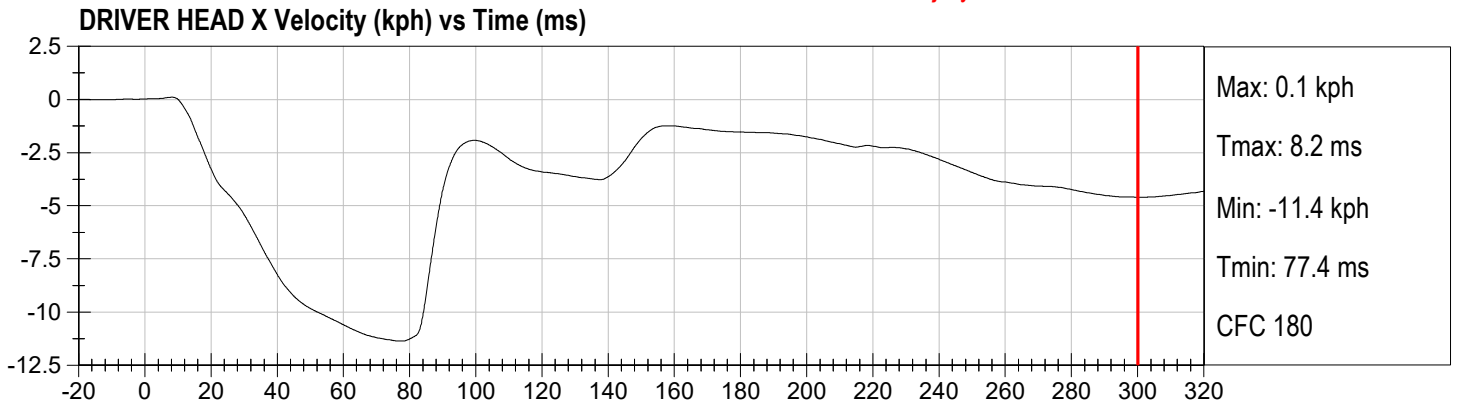

Injury Values Calculated between 0ms and 300ms

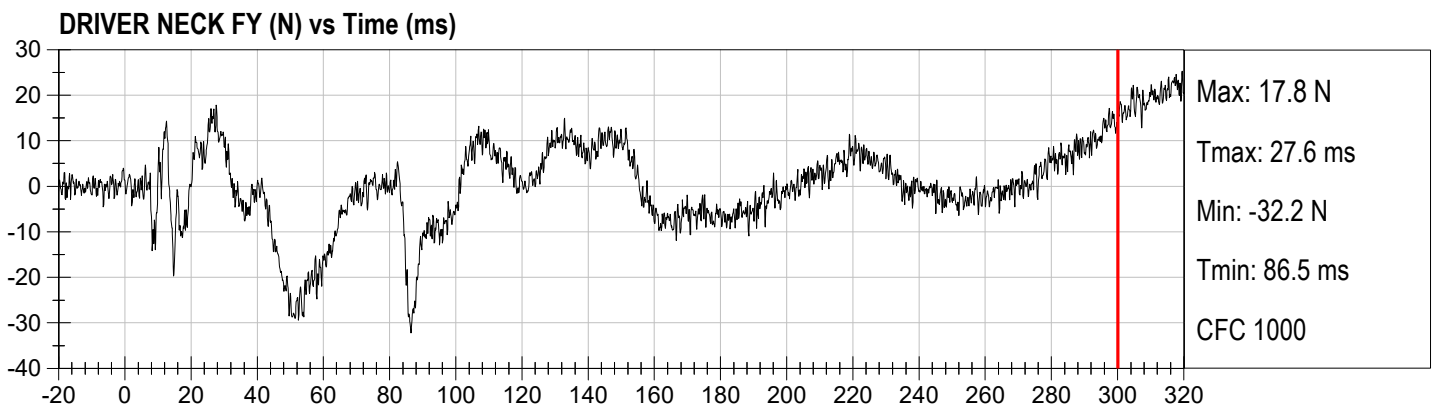

Injury Values Calculated between 0ms and 300ms

**DRIVER NECK MX (Nm) vs Time (ms)**

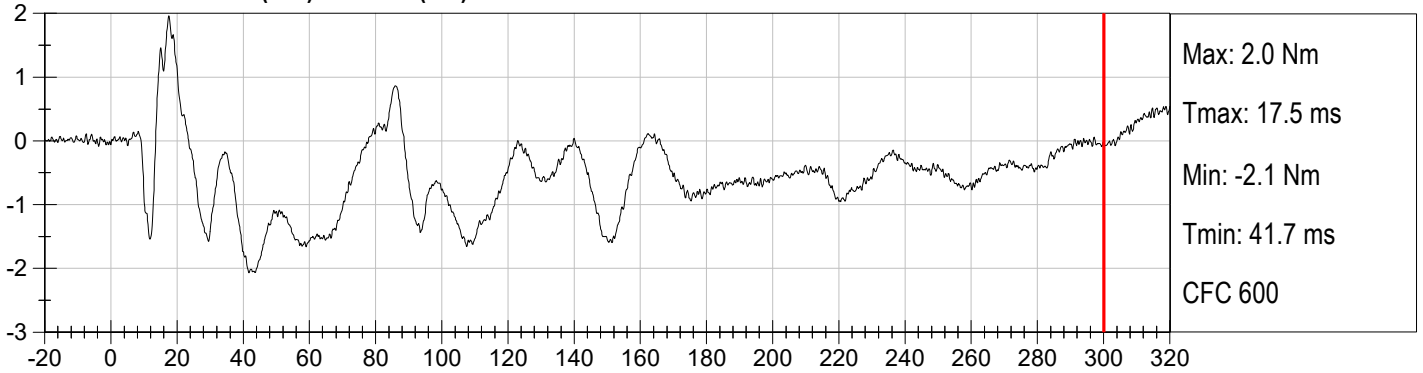

**DRIVER NECK MY (Nm) vs Time (ms)**

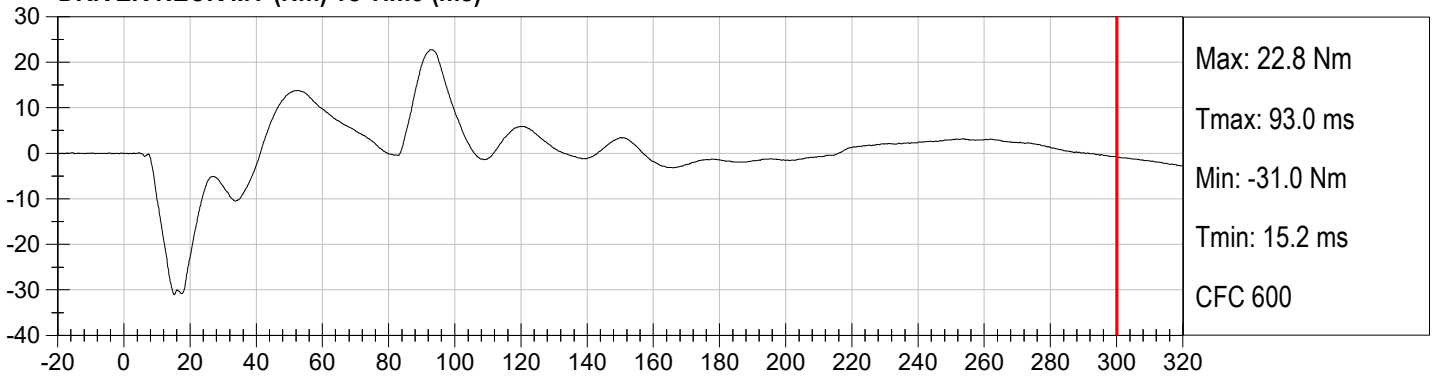

**DRIVER NECK MZ (Nm) vs Time (ms)**

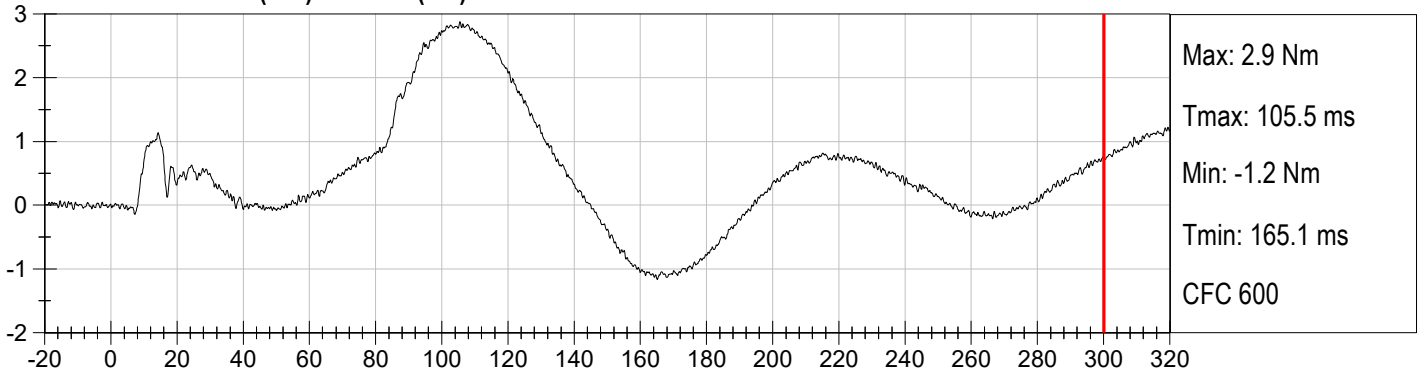

**DRIVER NECK MY Occipital Condyle (Nm) vs Time (ms)**

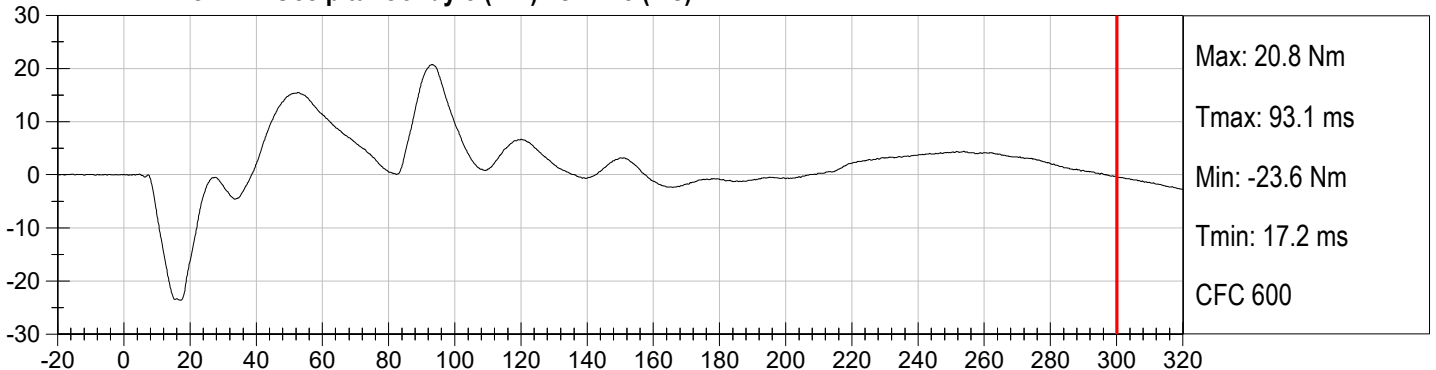

Injury Values Calculated between 0ms and 300ms

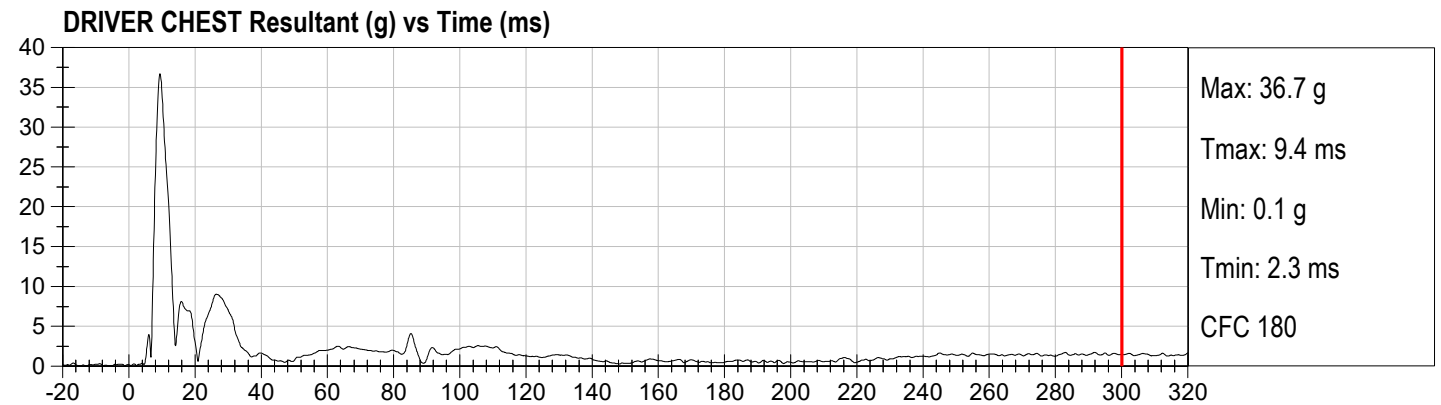
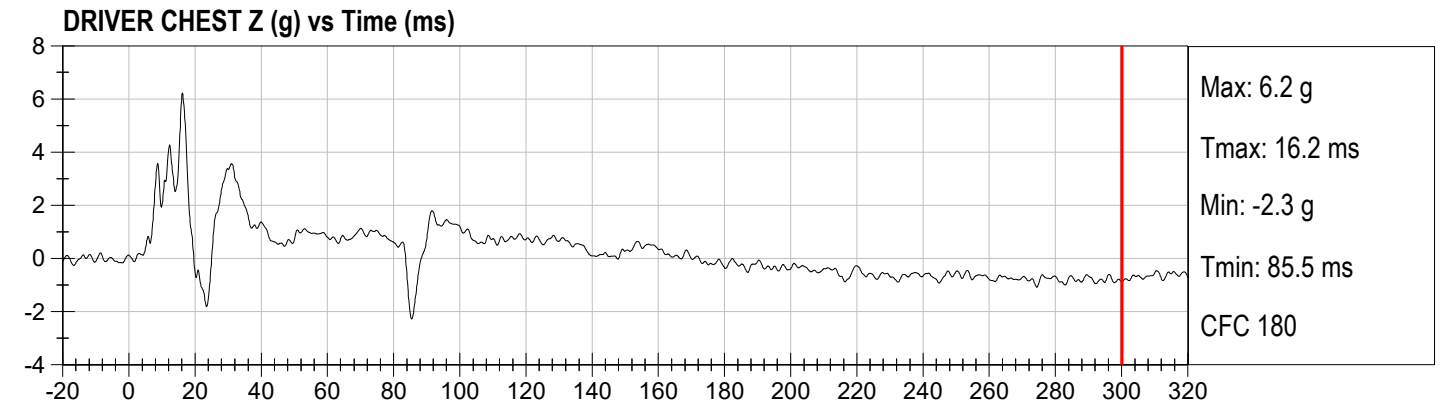
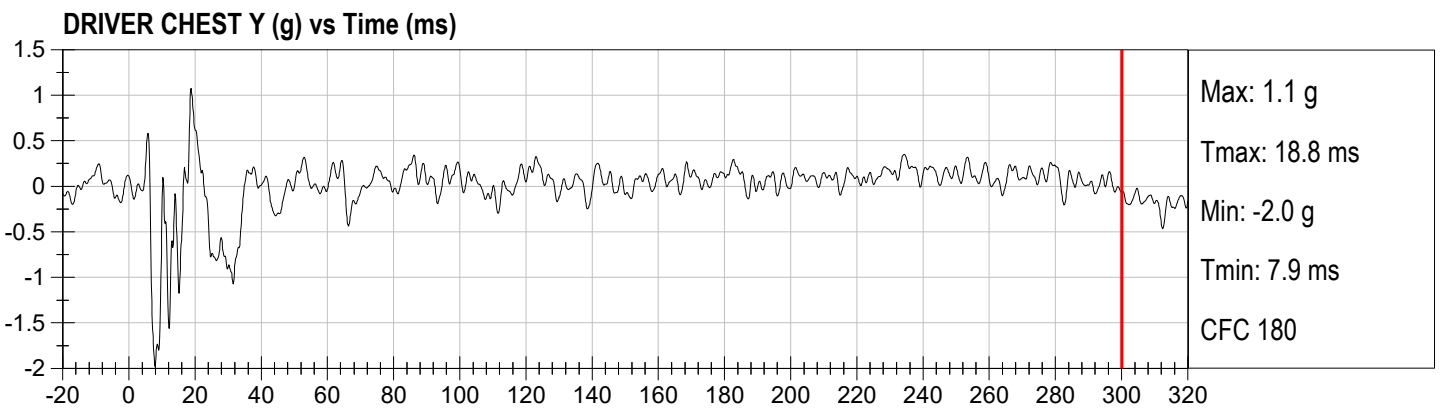
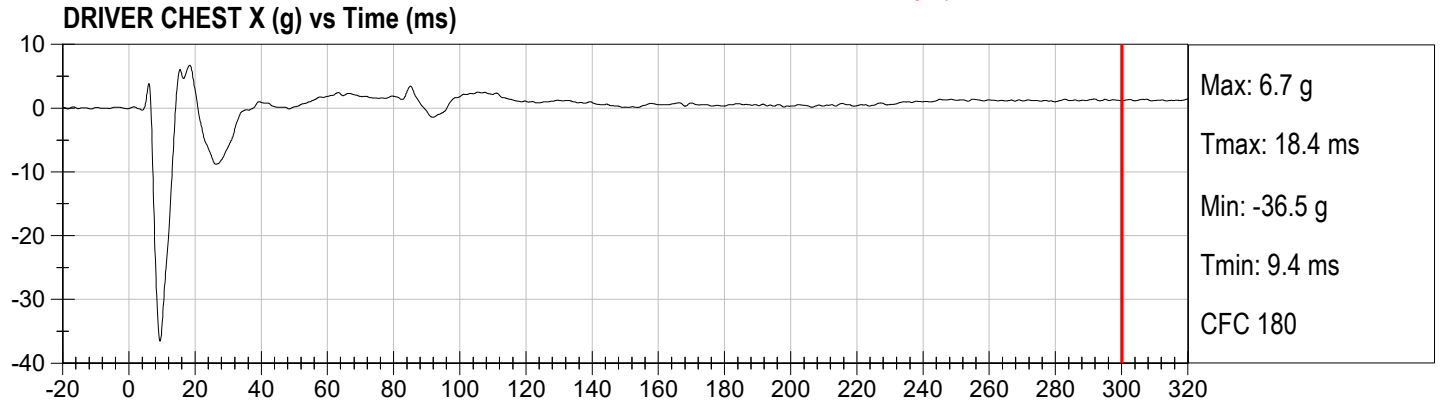

Injury Values Calculated between 0ms and 300ms

**DRIVER CHEST X Velocity (kph) vs Time (ms)**

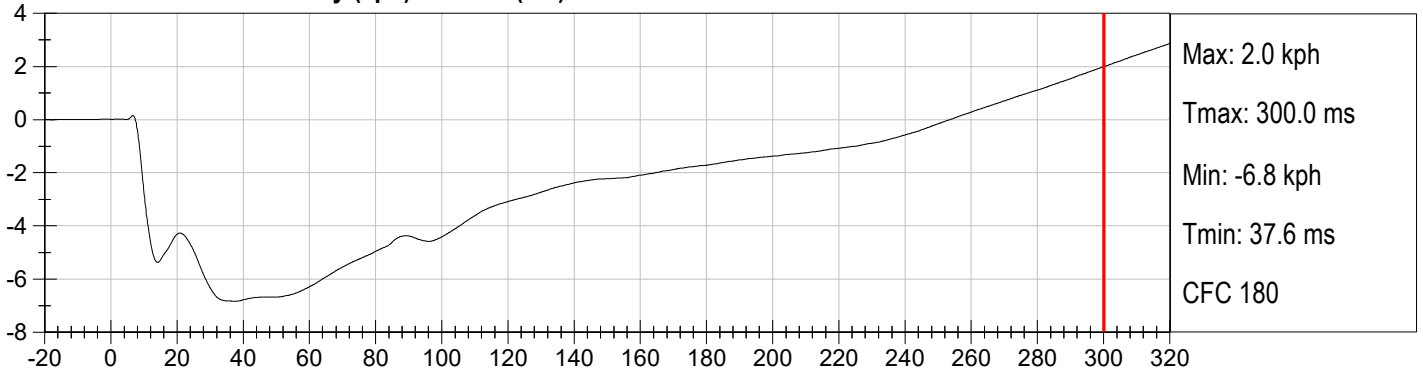

**DRIVER CHEST Y Velocity (kph) vs Time (ms)**

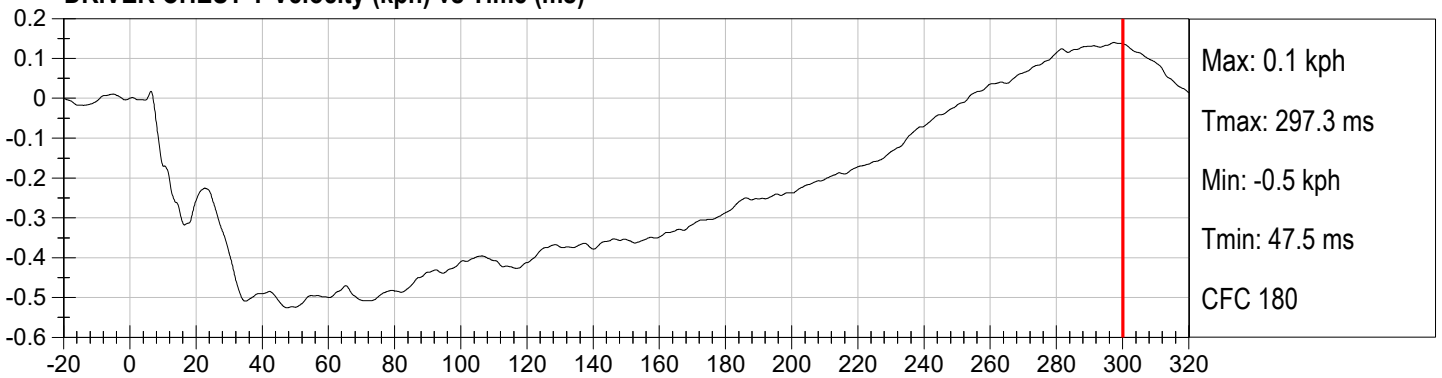

**DRIVER CHEST Z Velocity (kph) vs Time (ms)**

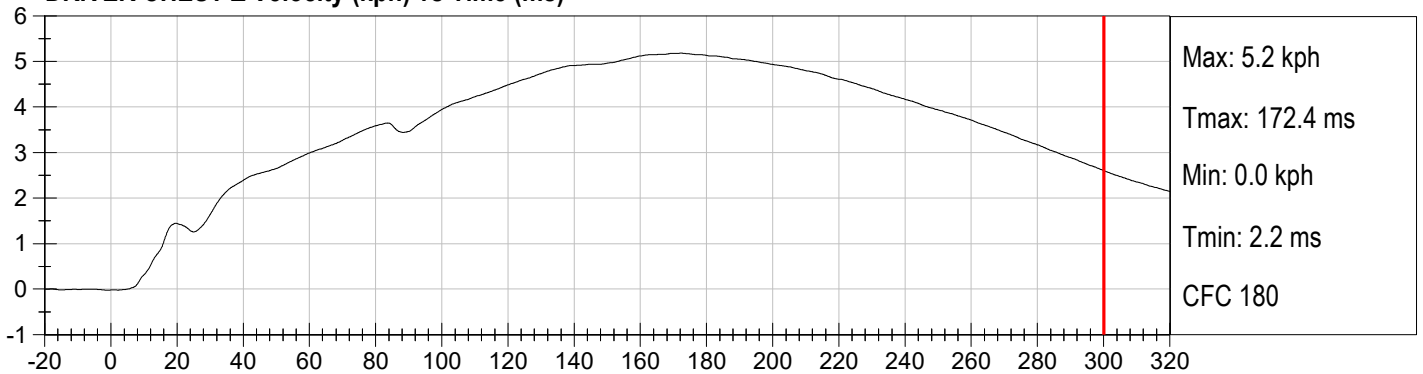

**DRIVER CHEST DISPLACEMENT (mm) vs Time (ms)**

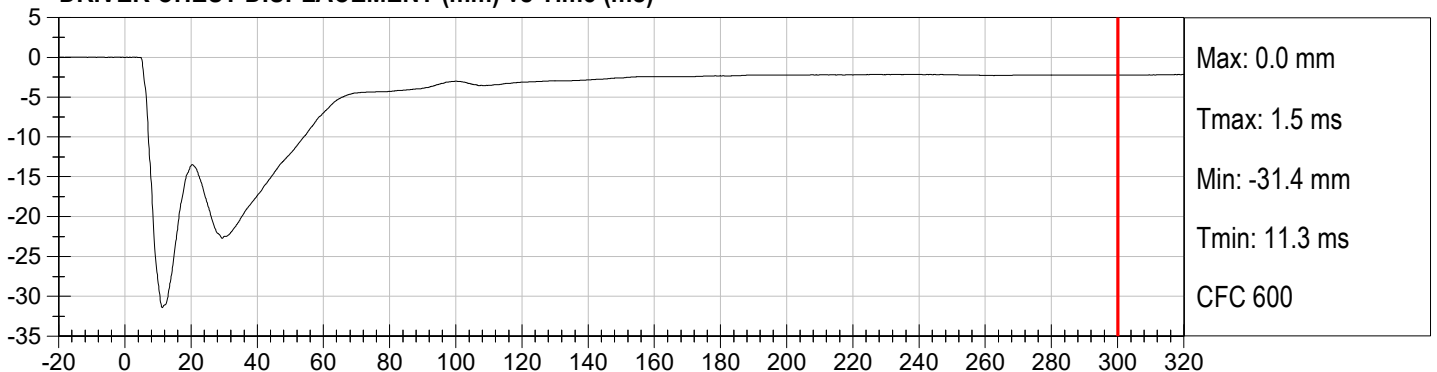

Injury Values Calculated between 0ms and 300ms

DRIVER LEFT FEMUR (N) vs Time (ms)

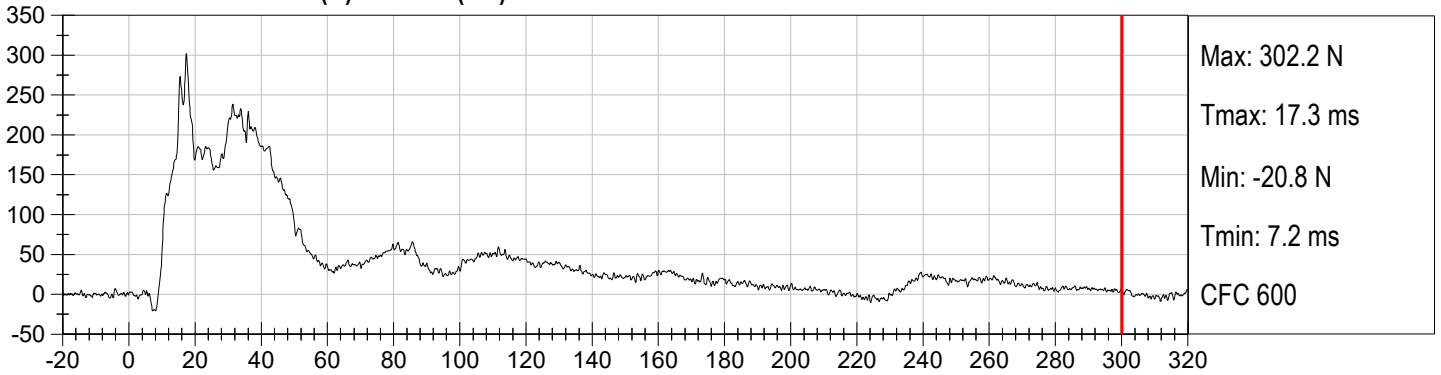

DRIVER RIGHT FEMUR (N) vs Time (ms)

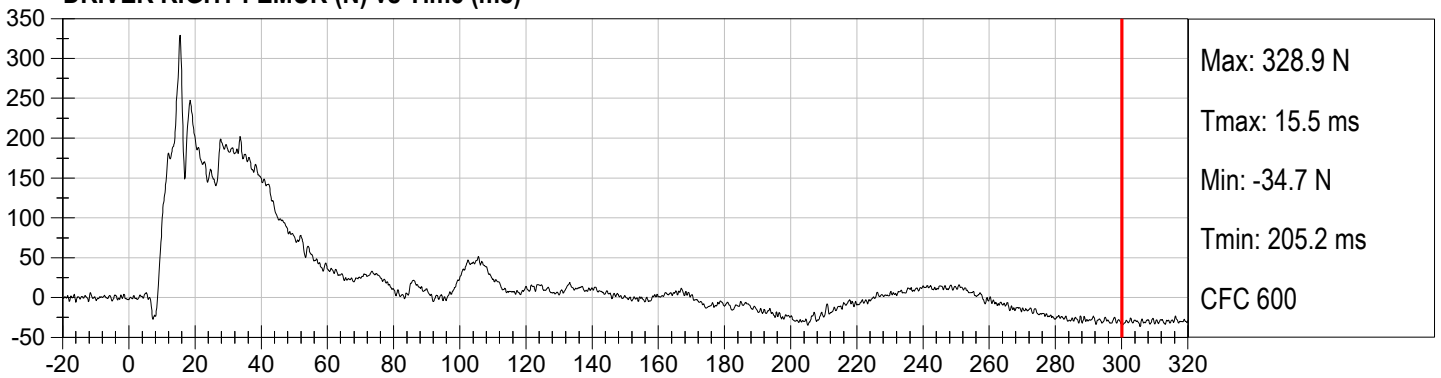

Injury Values Calculated between 0ms and 300ms

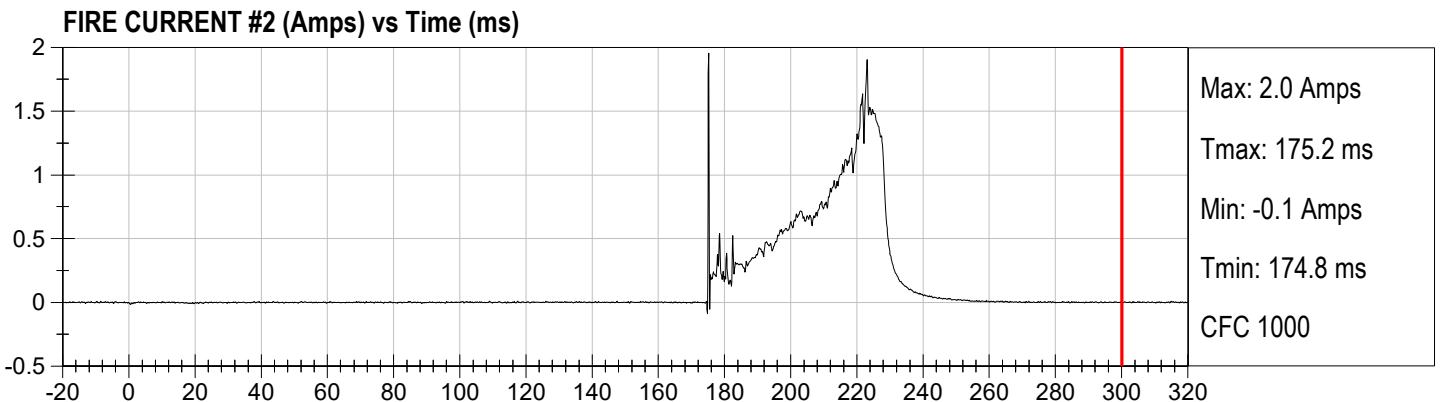
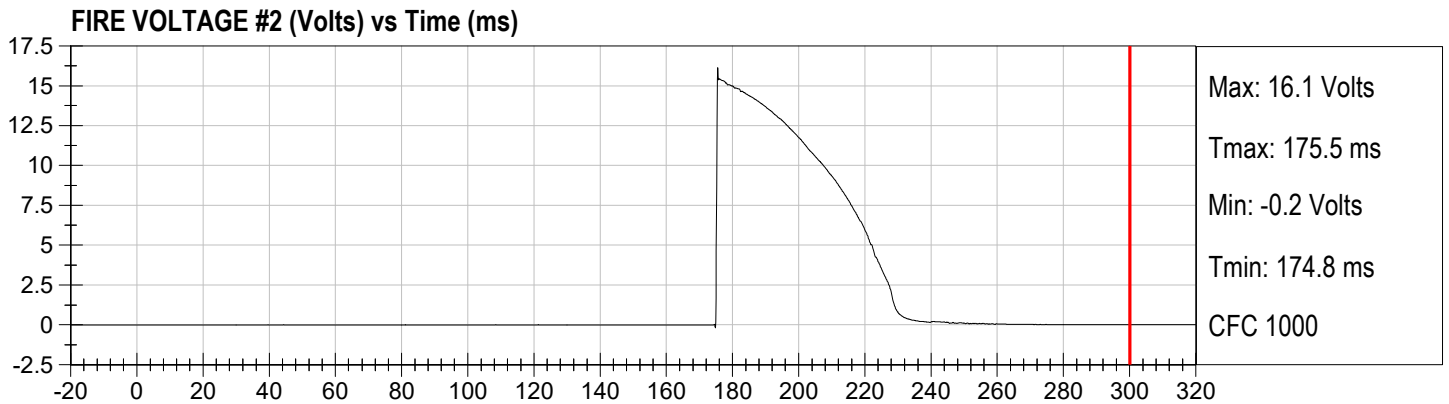
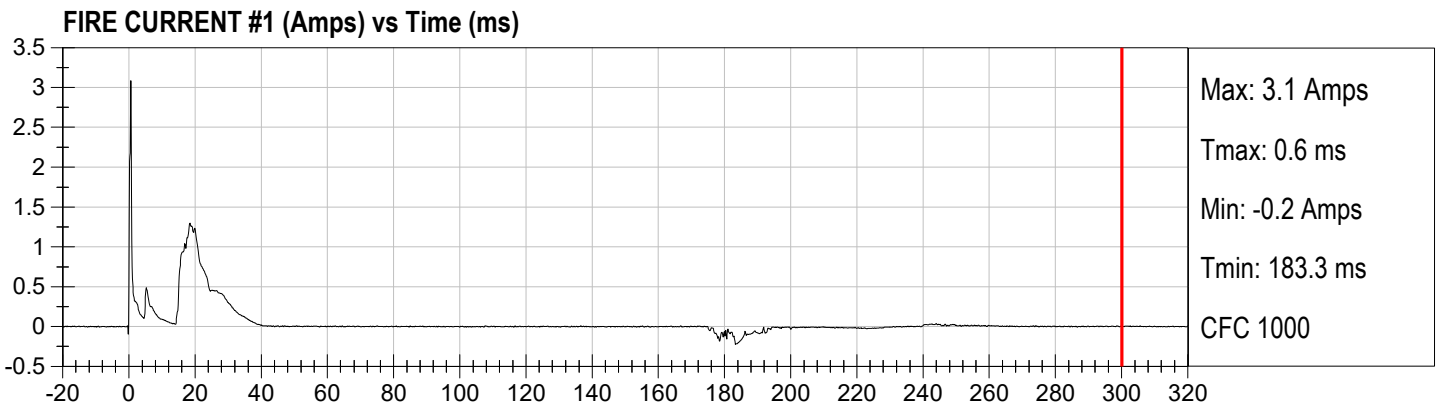
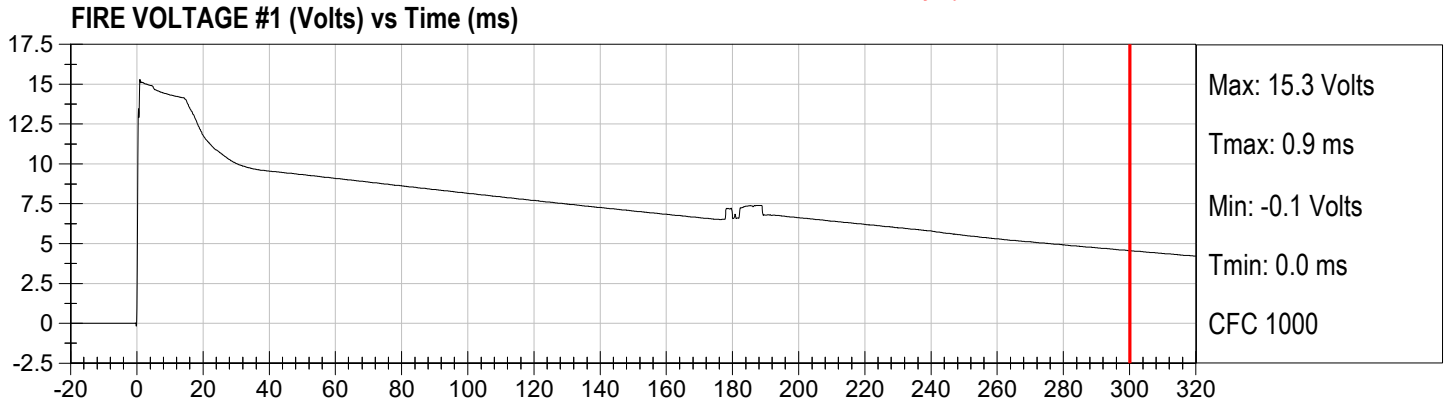

Injury Values Calculated between 0ms and 300ms

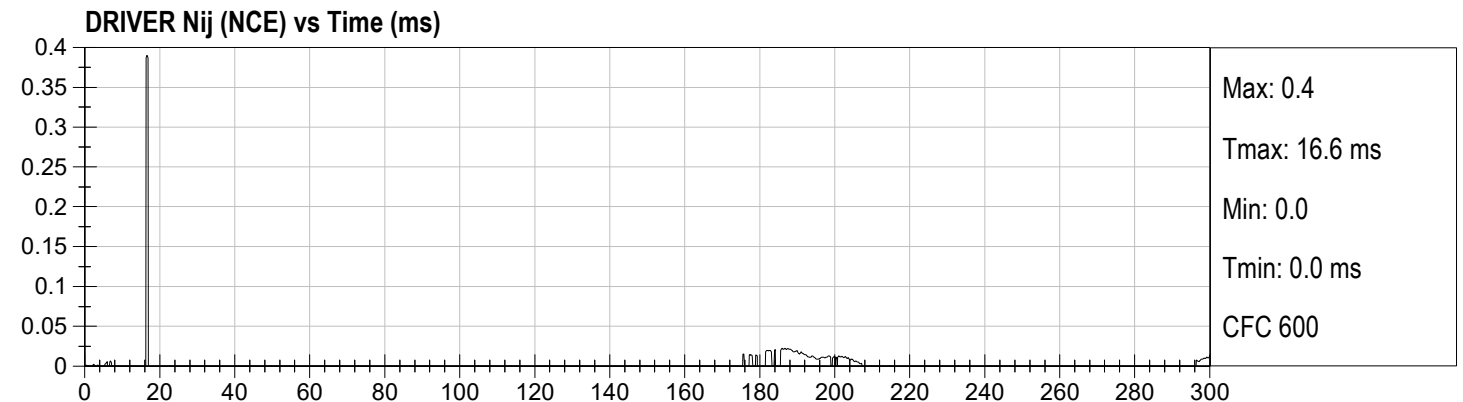
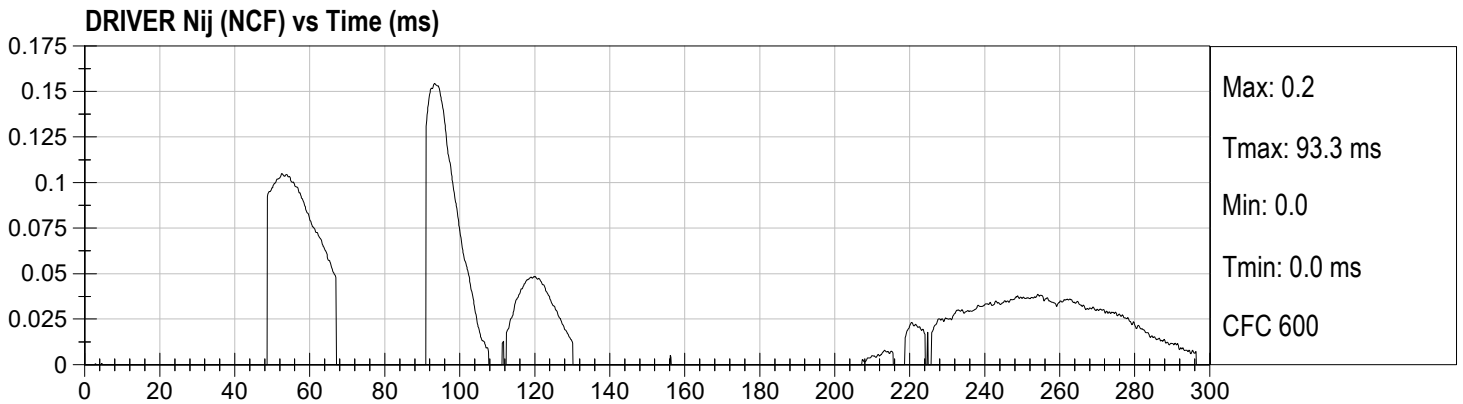
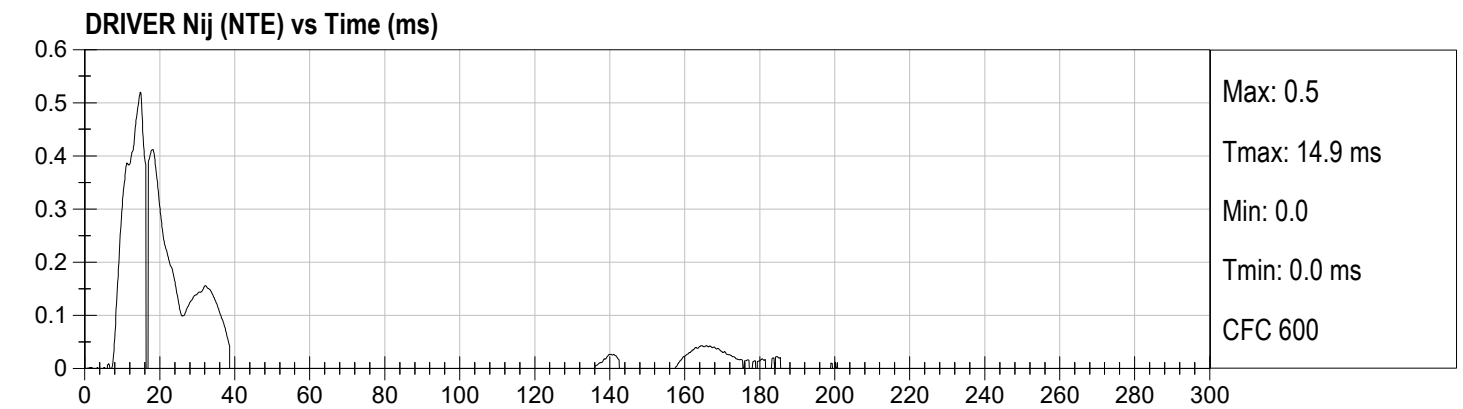
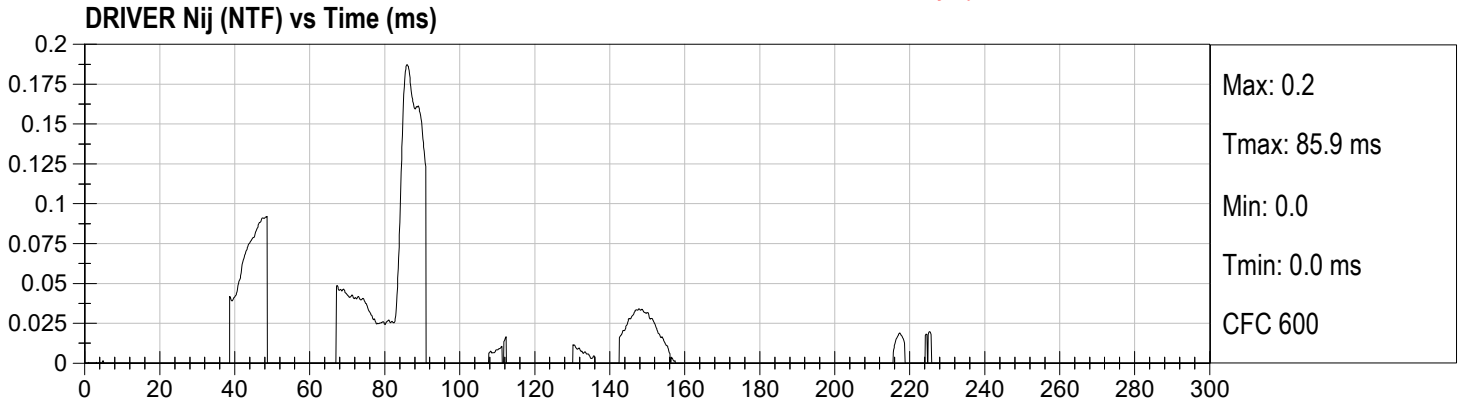

Injury Values Calculated between 0ms and 100ms

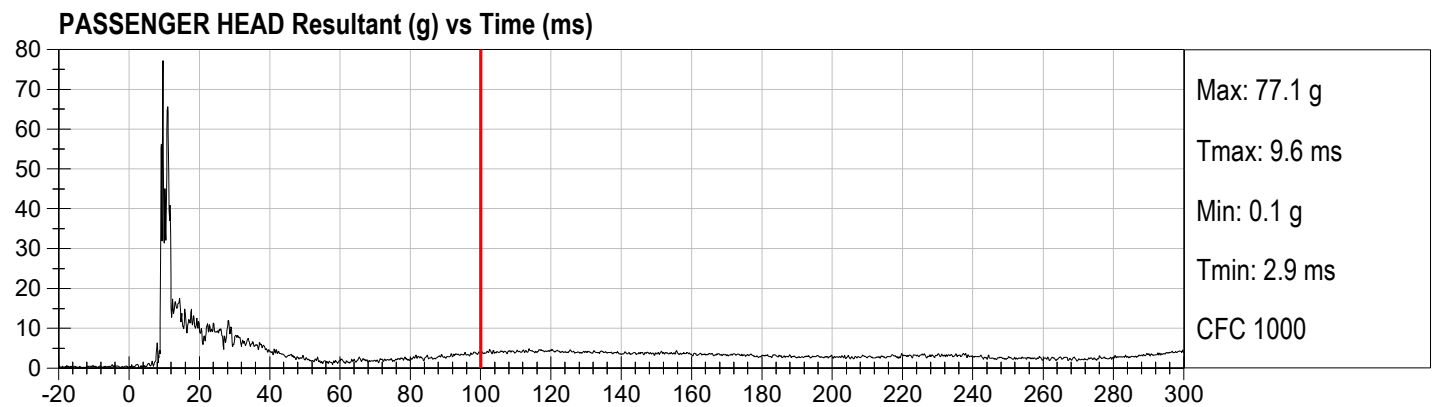
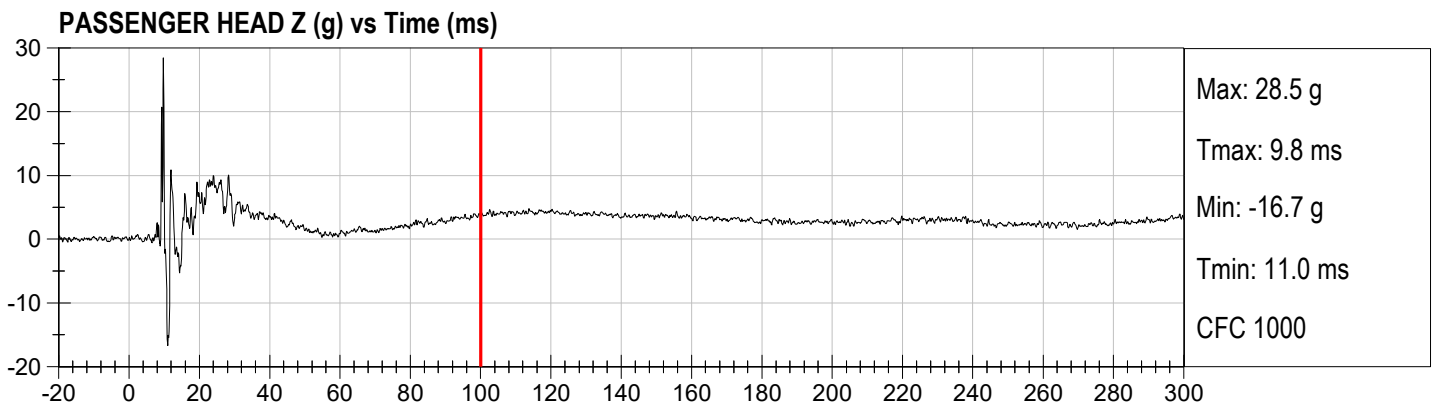
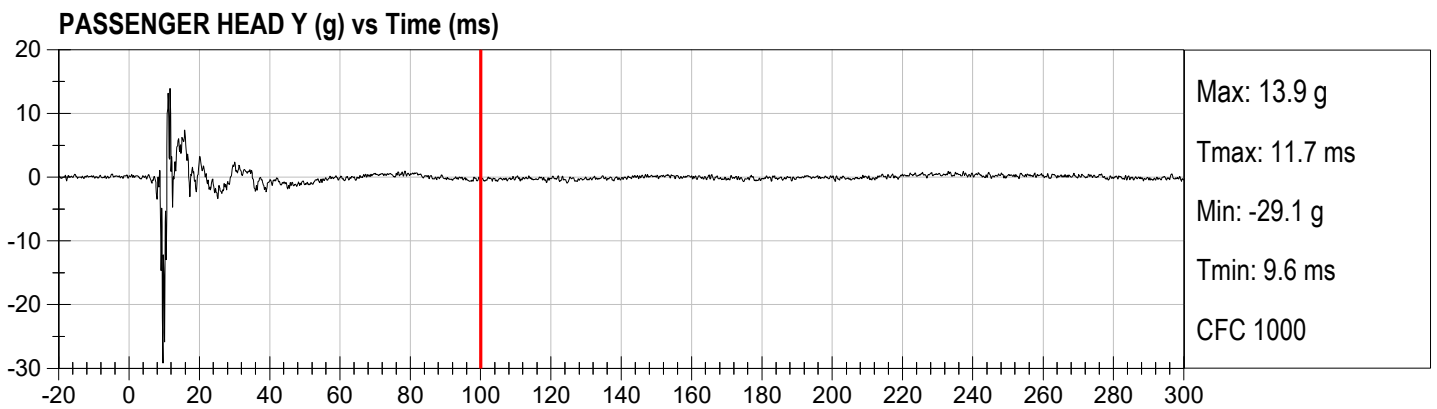
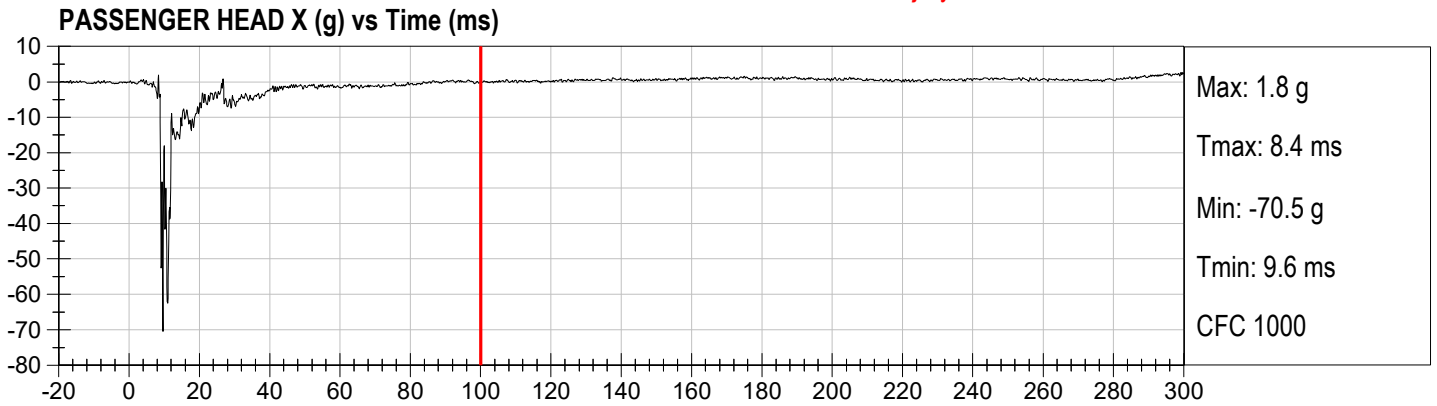

Injury Values Calculated between 0ms and 100ms

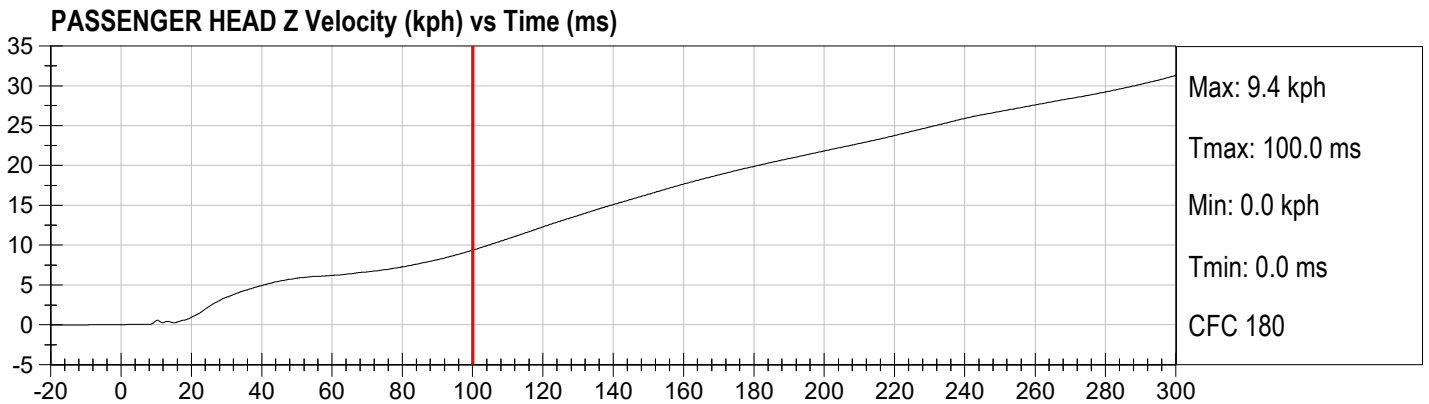
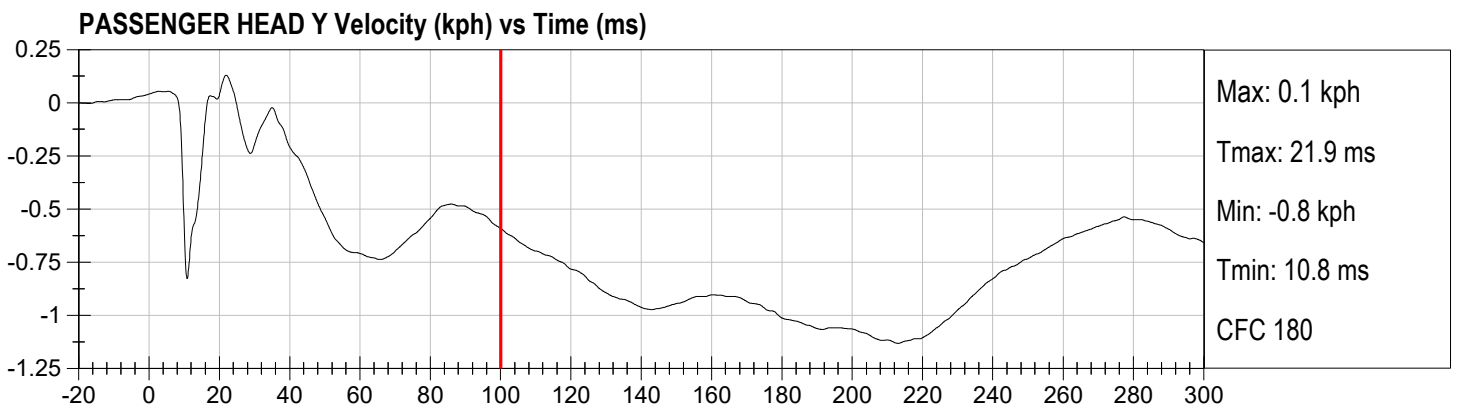
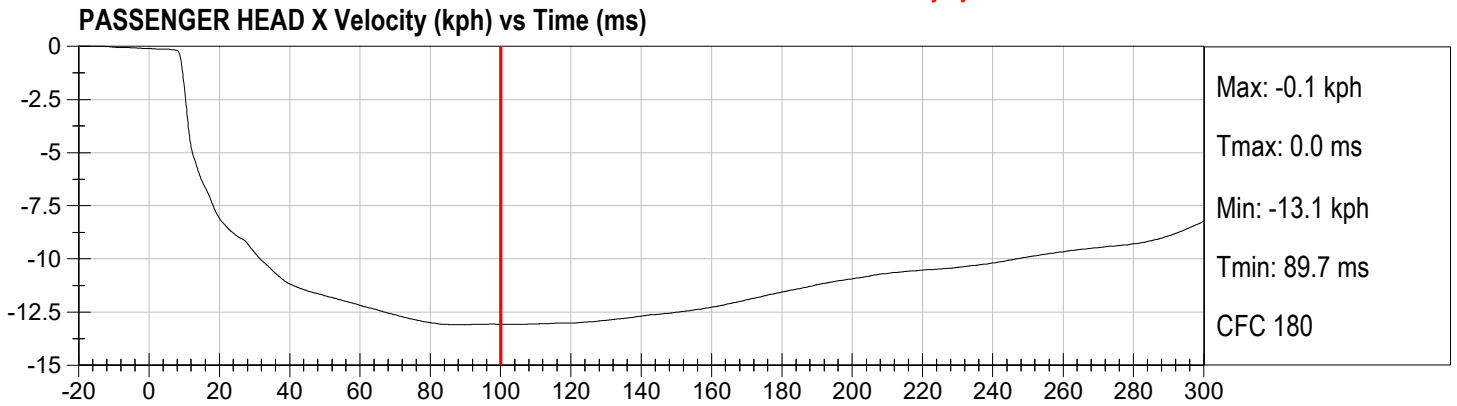

Injury Values Calculated between 0ms and 100ms

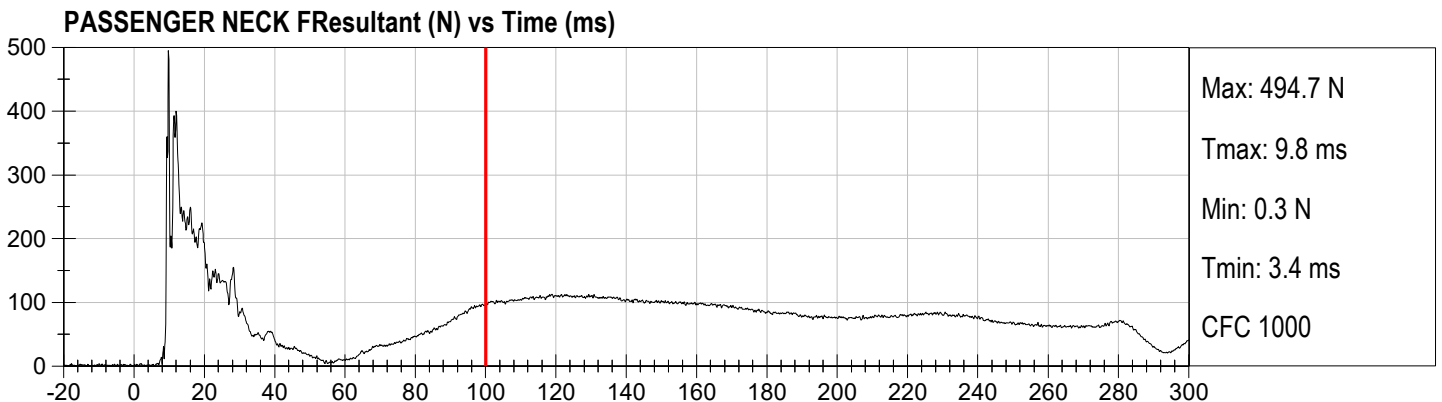
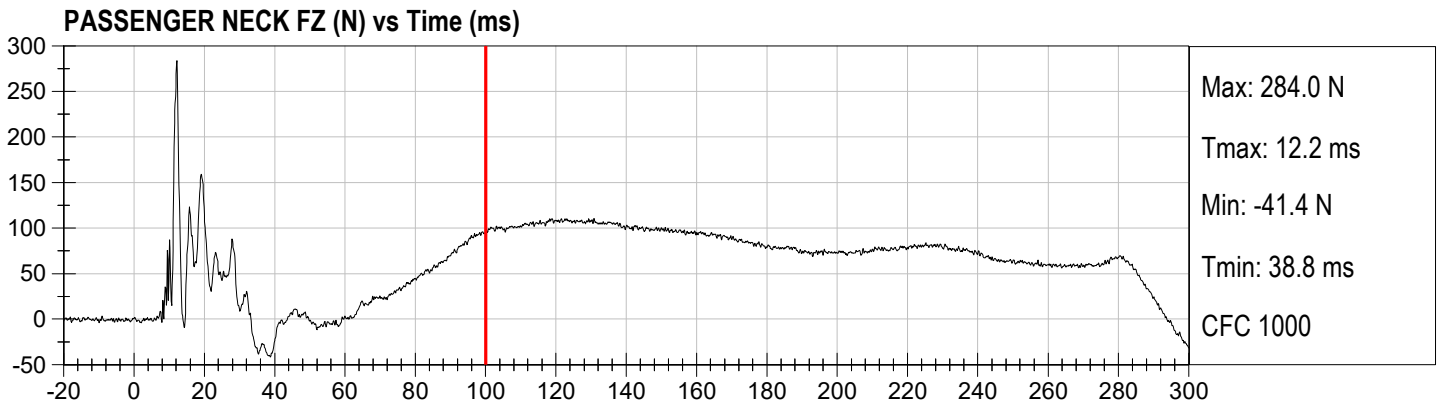
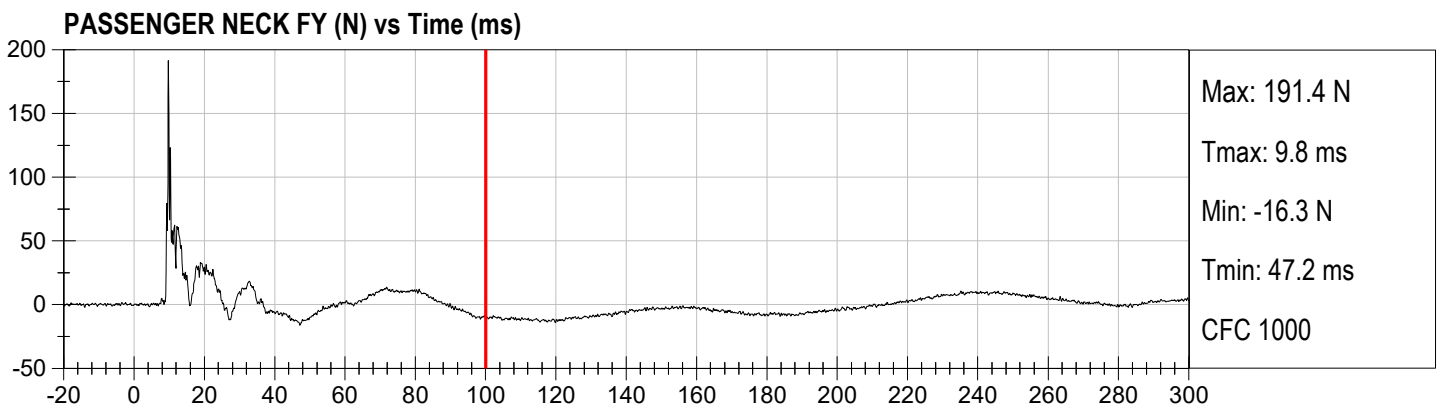
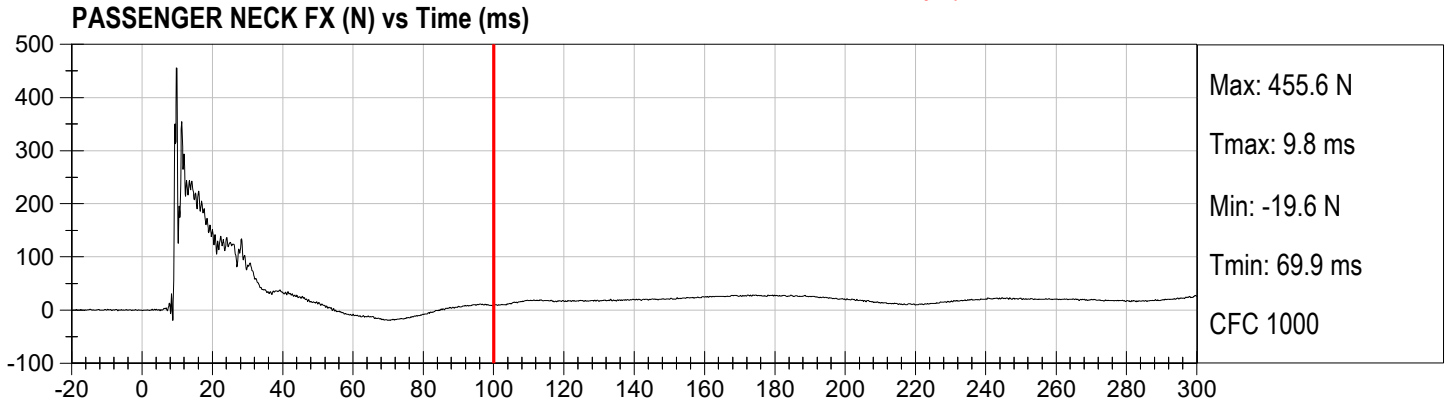

Injury Values Calculated between 0ms and 100ms

PASSENGER NECK MX (Nm) vs Time (ms)

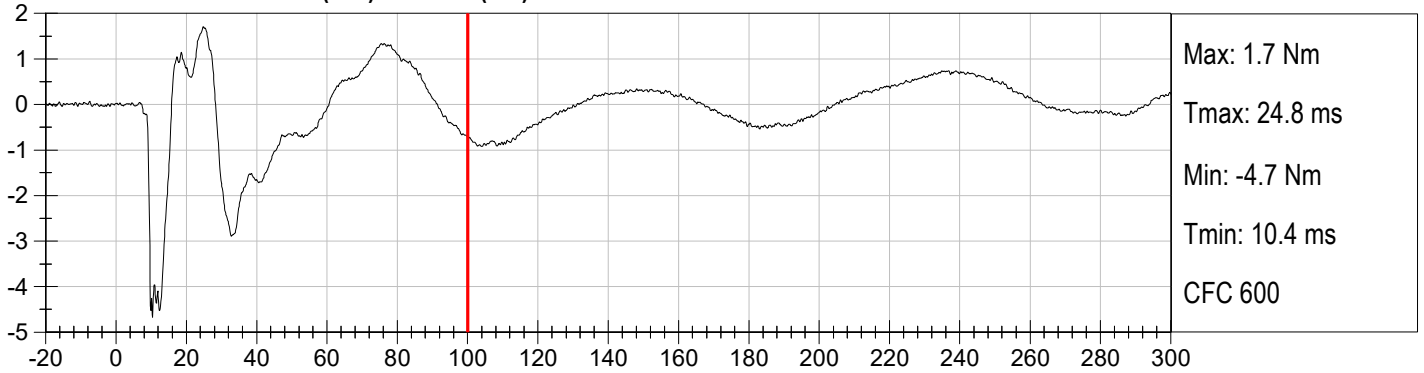

PASSENGER NECK MY (Nm) vs Time (ms)

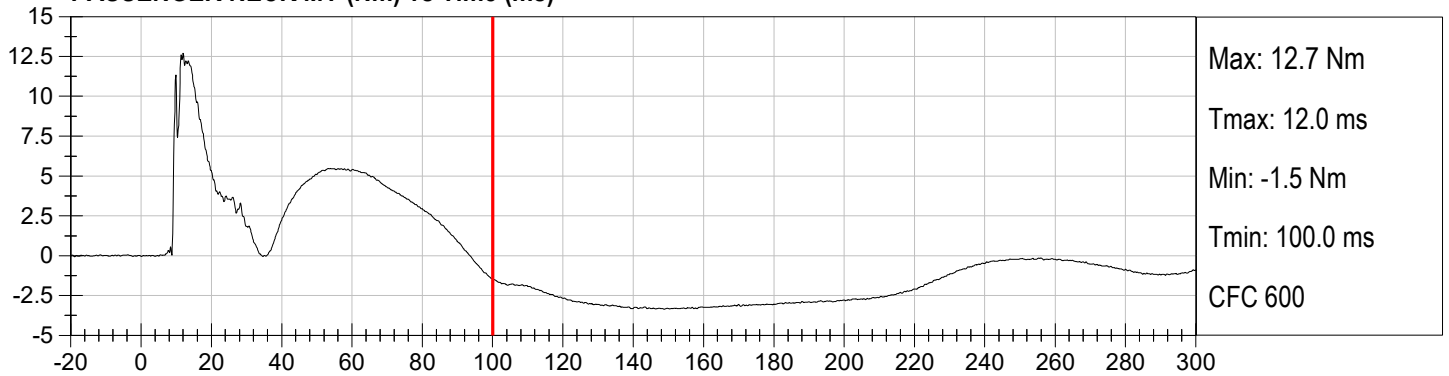

PASSENGER NECK MZ (Nm) vs Time (ms)

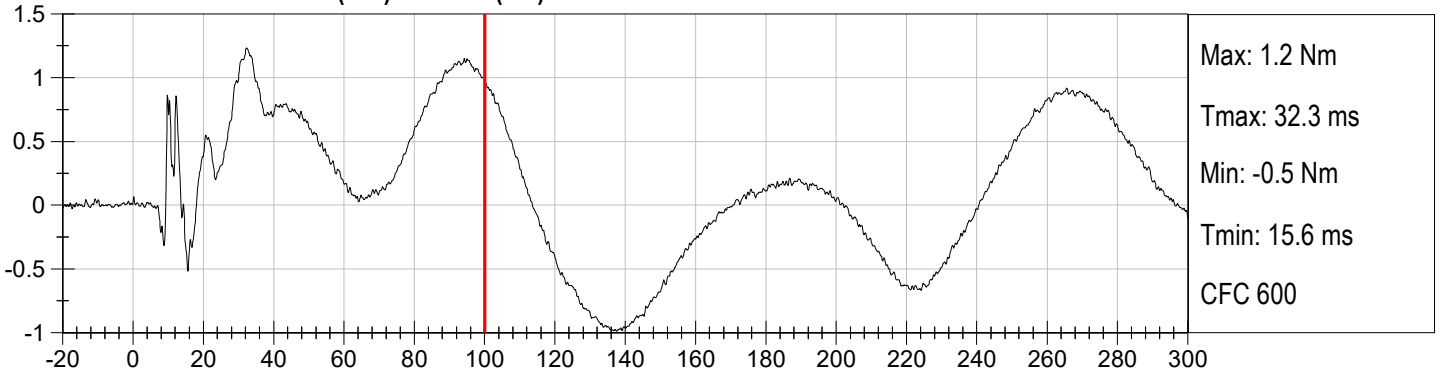

PASSENGER NECK MY Occipital Condyle (Nm) vs Time (ms)

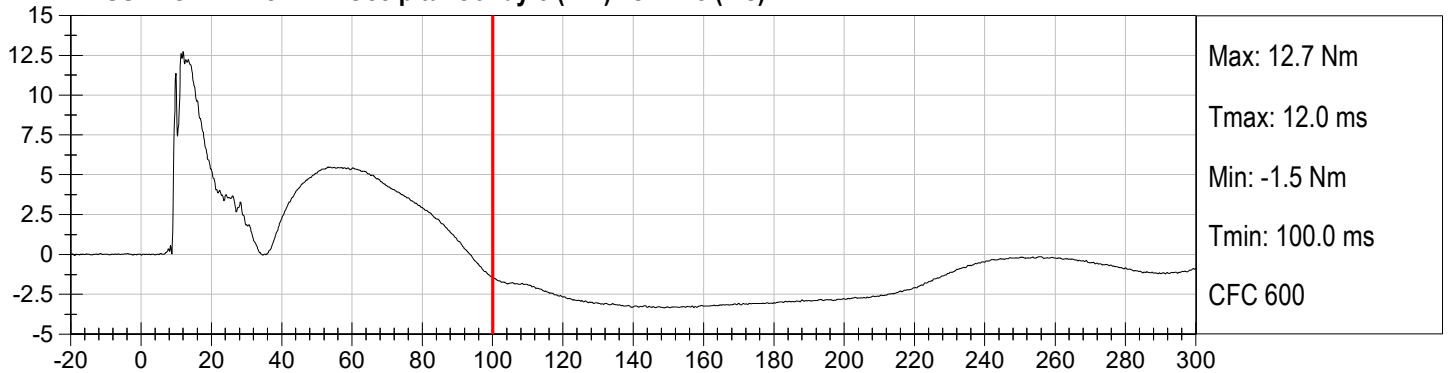

Injury Values Calculated between 0ms and 100ms

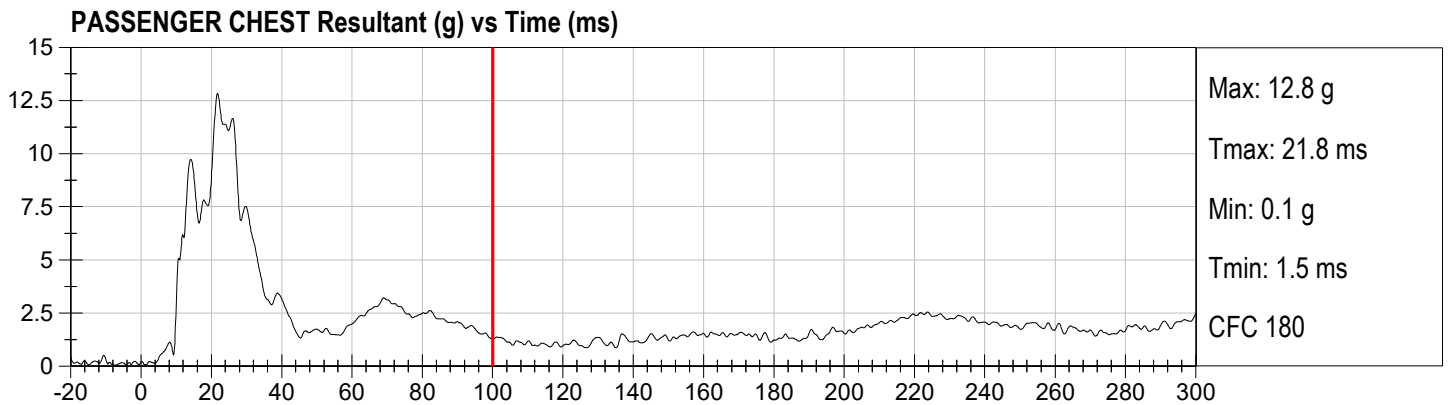
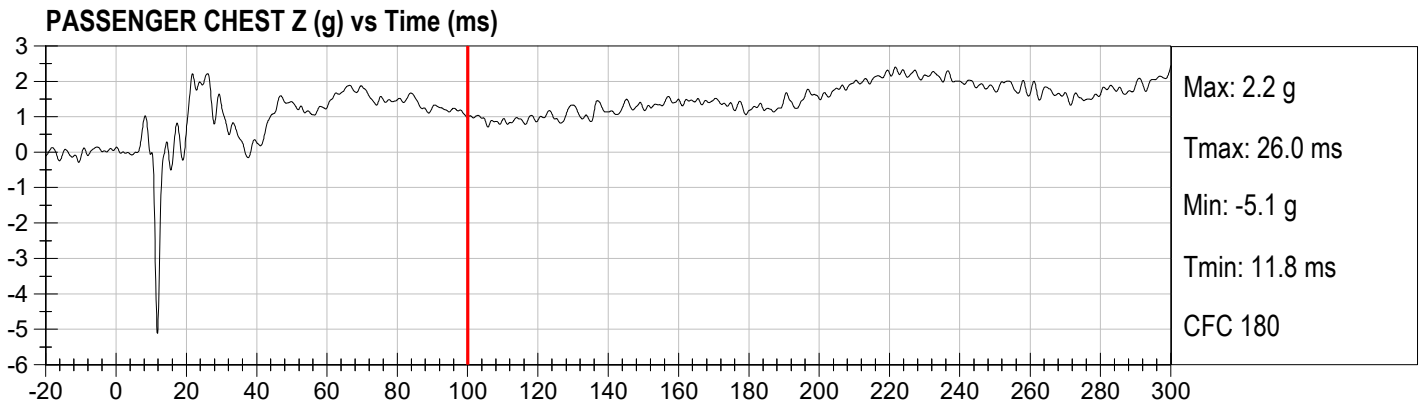
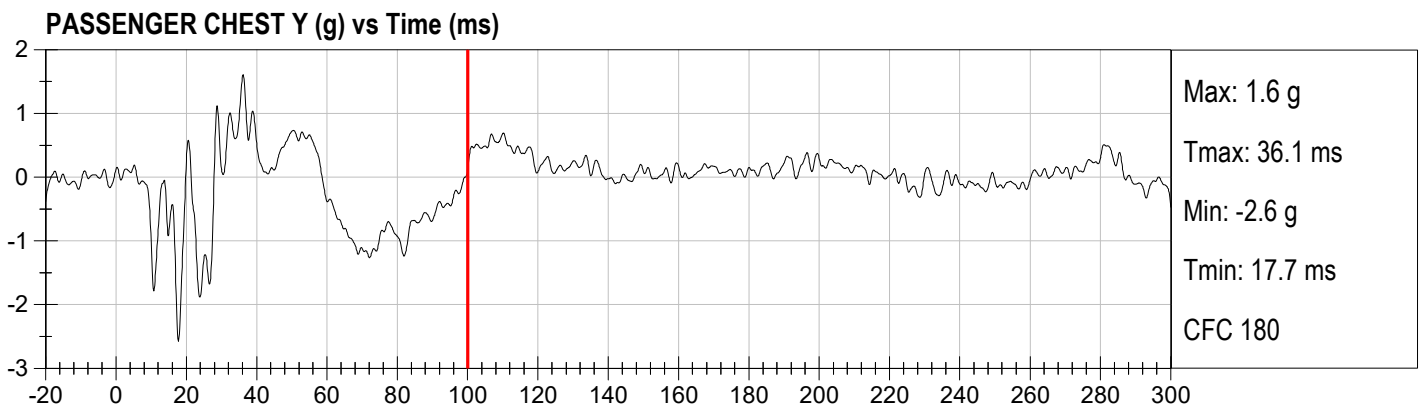
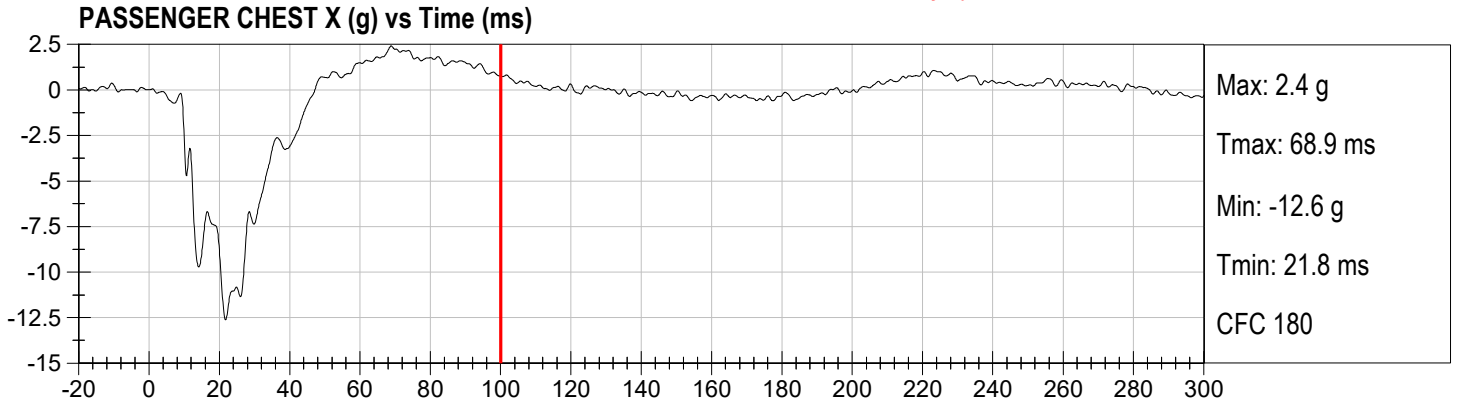

Injury Values Calculated between 0ms and 100ms

PASSENGER CHEST X Velocity (kph) vs Time (ms)

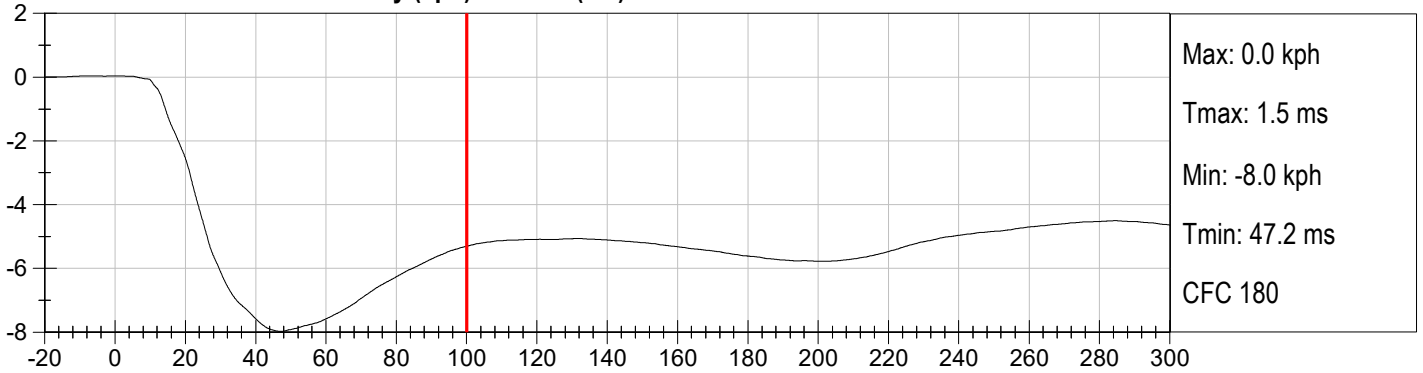

PASSENGER CHEST Y Velocity (kph) vs Time (ms)

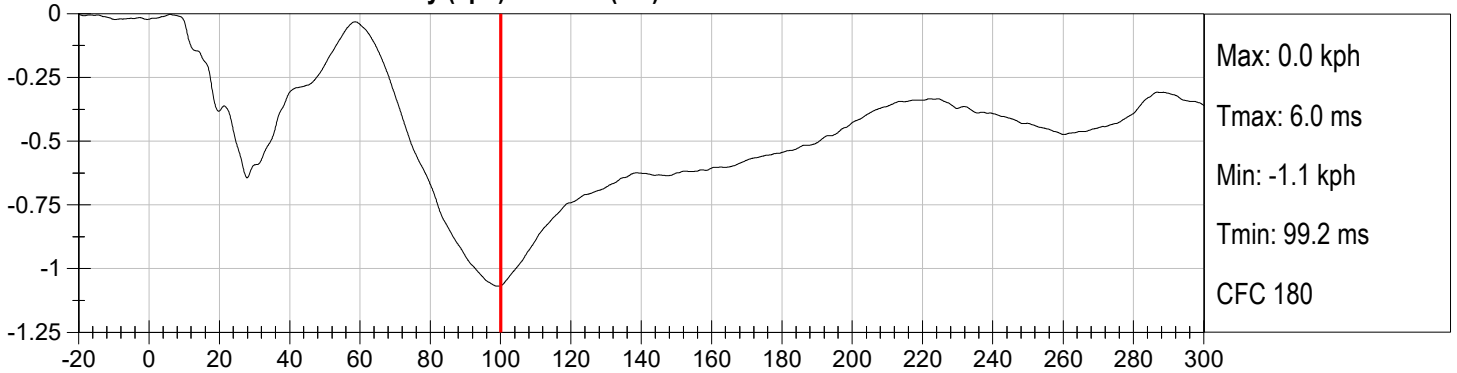

PASSENGER CHEST Z Velocity (kph) vs Time (ms)

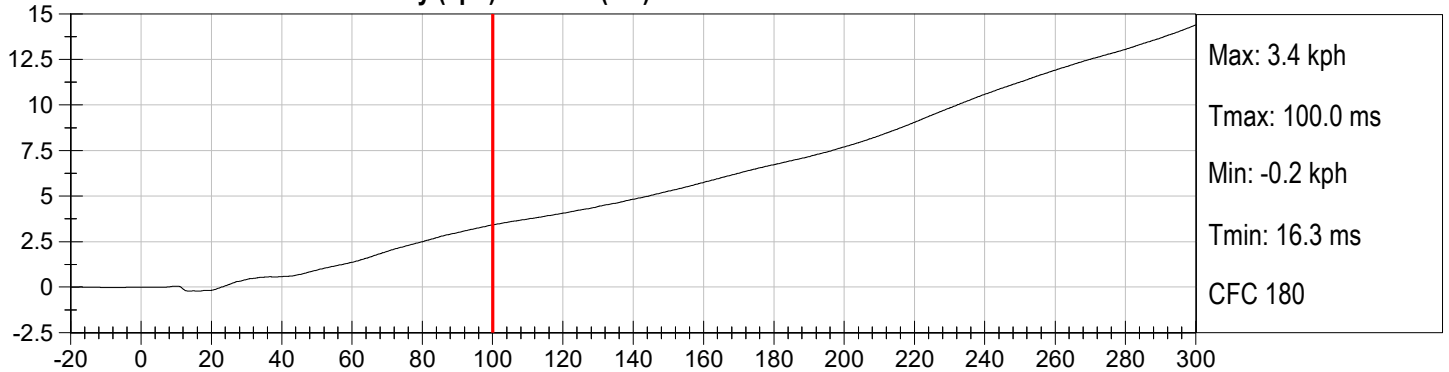

PASSENGER CHEST DISPLACEMENT (mm) vs Time (ms)

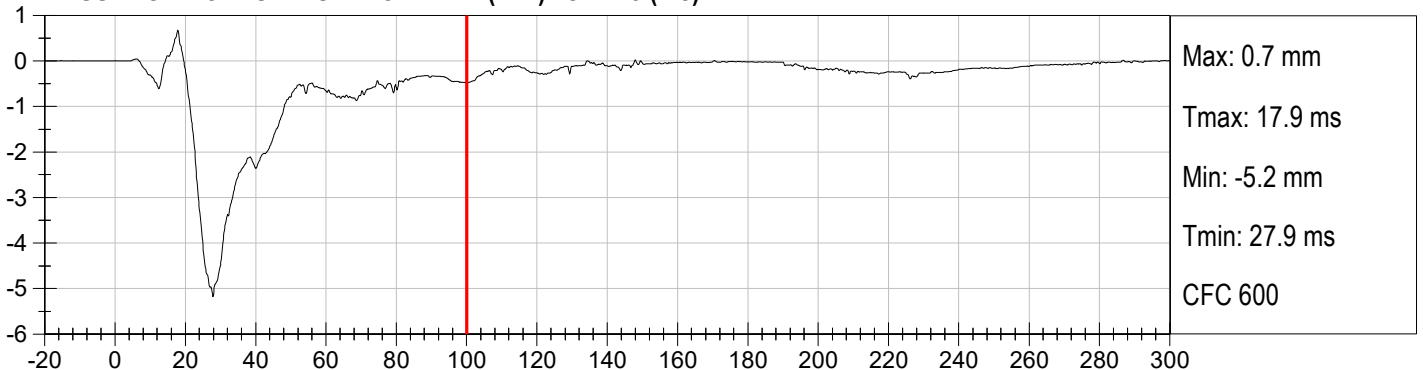

Injury Values Calculated between 0ms and 100ms

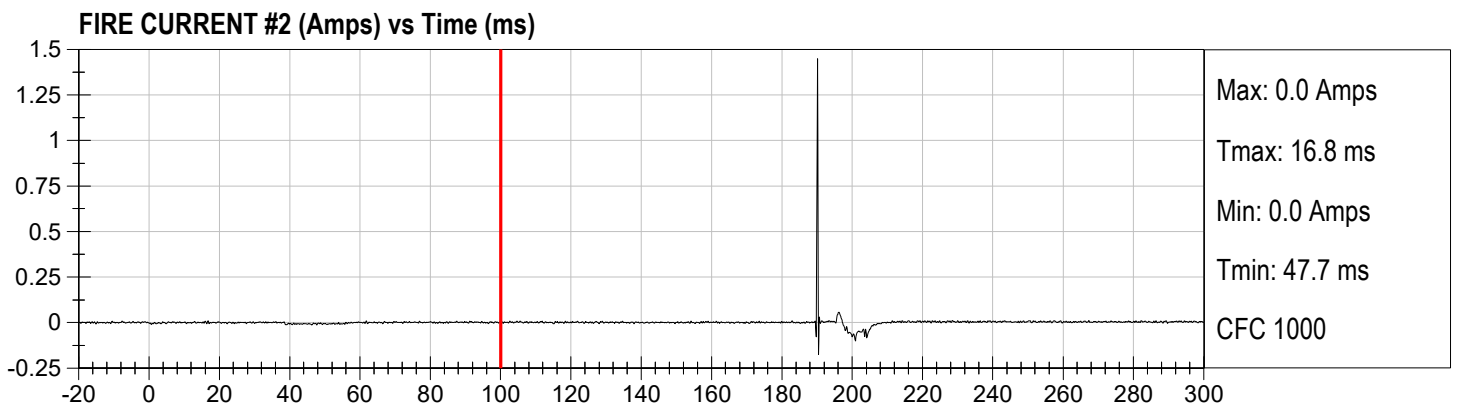
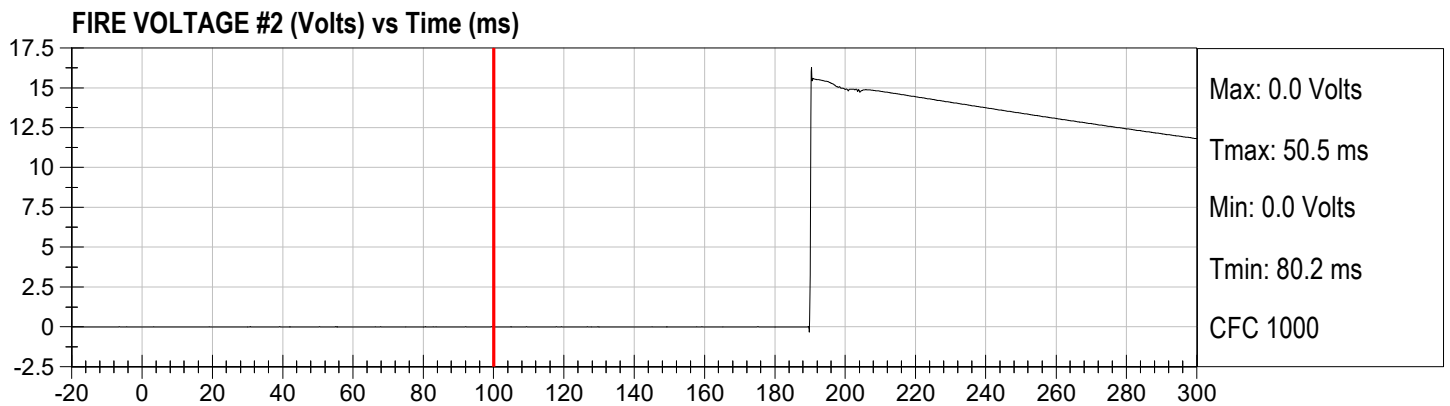
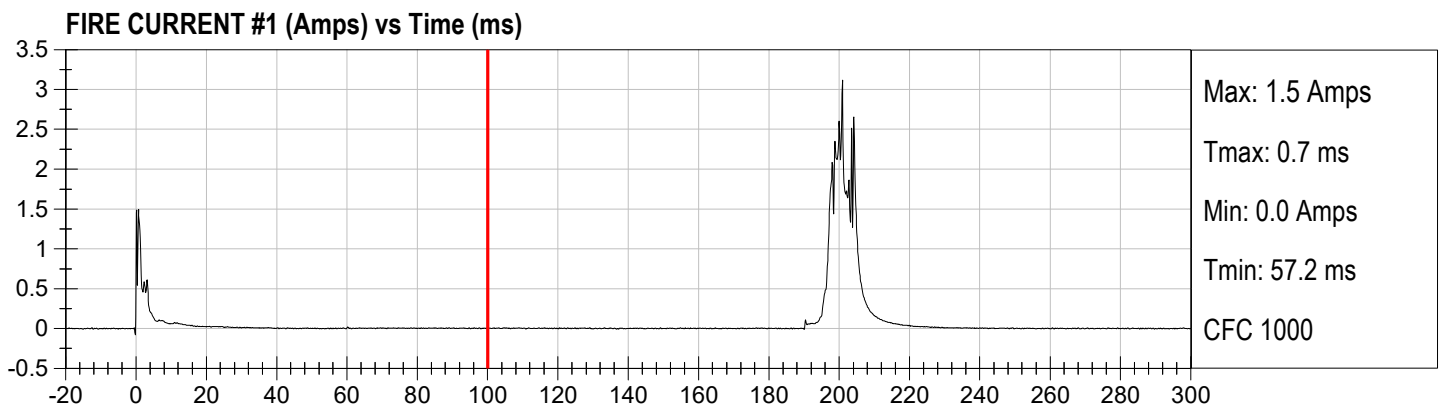

Injury Values Calculated between 0ms and 100ms

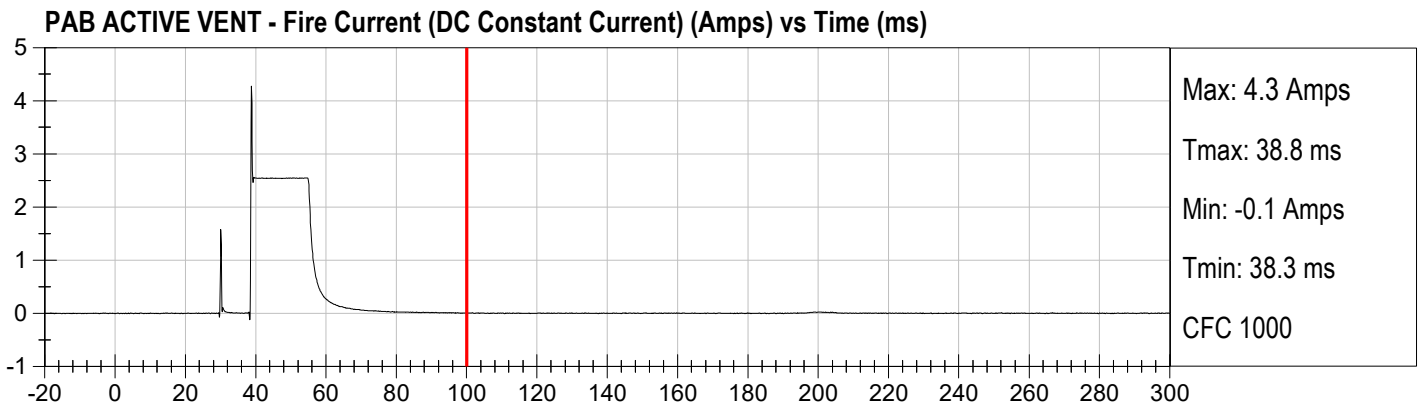
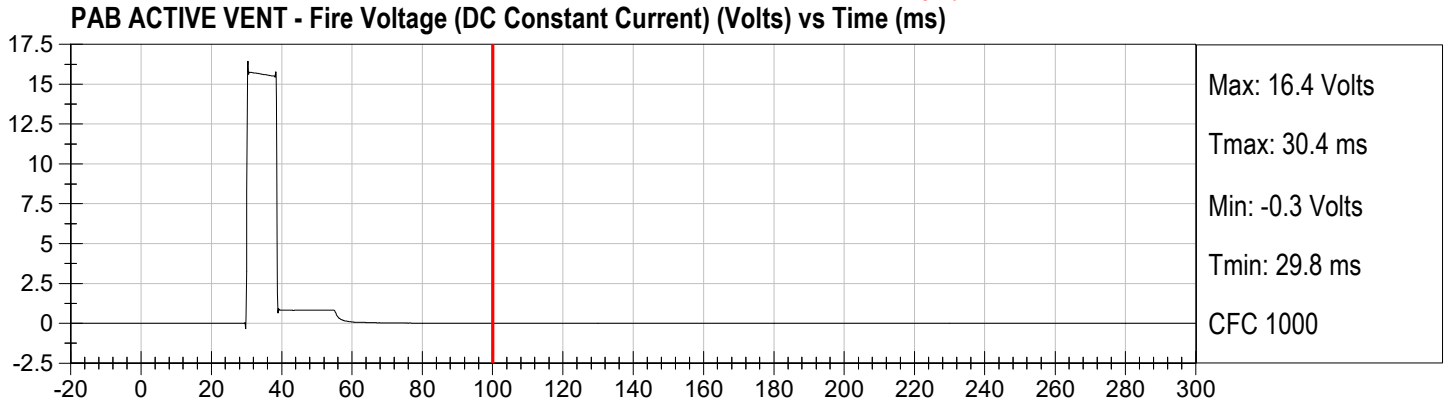

Injury Values Calculated between 0ms and 100ms

PASSENGER Nij (NTF) vs Time (ms)

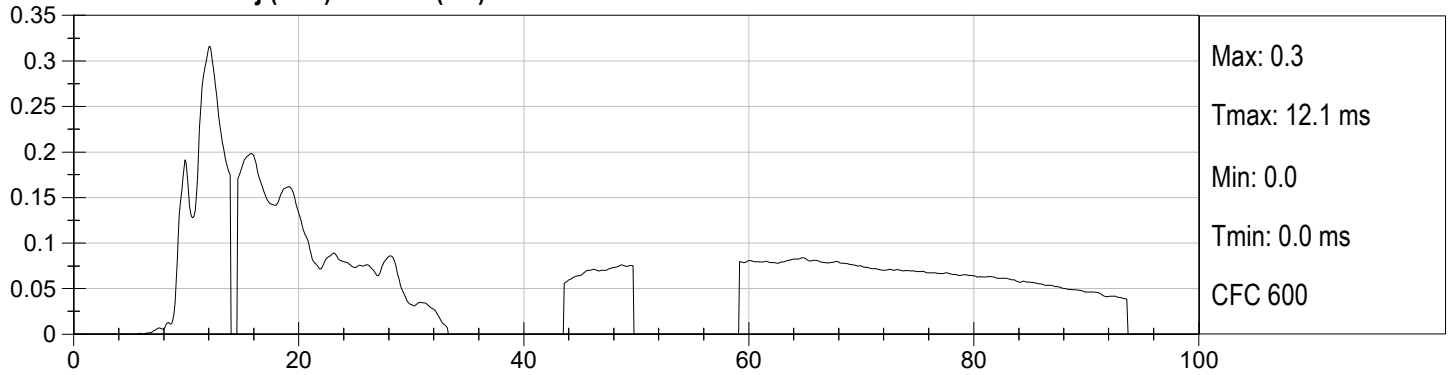

PASSENGER Nij (NTE) vs Time (ms)

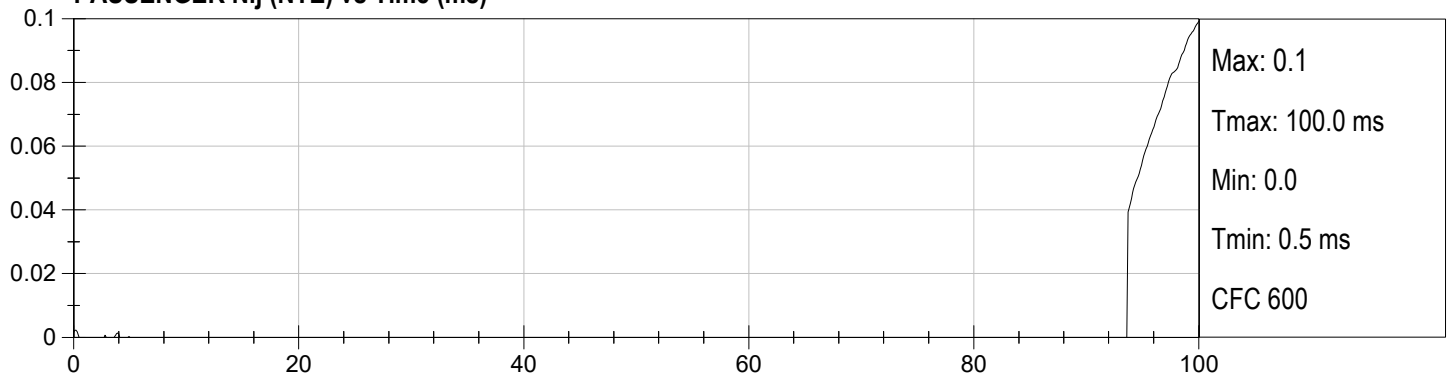

PASSENGER Nij (NCF) vs Time (ms)

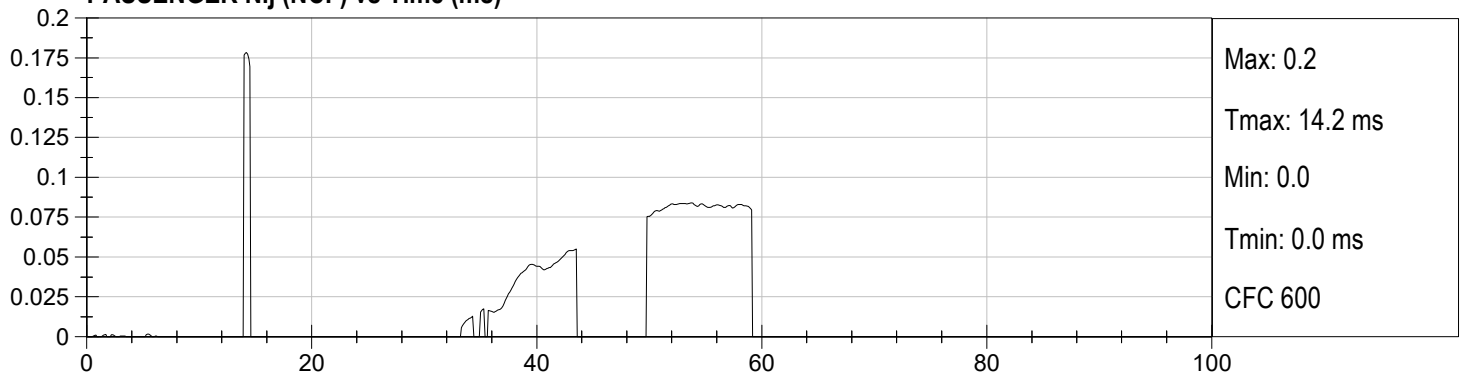

PASSENGER Nij (NCE) vs Time (ms)

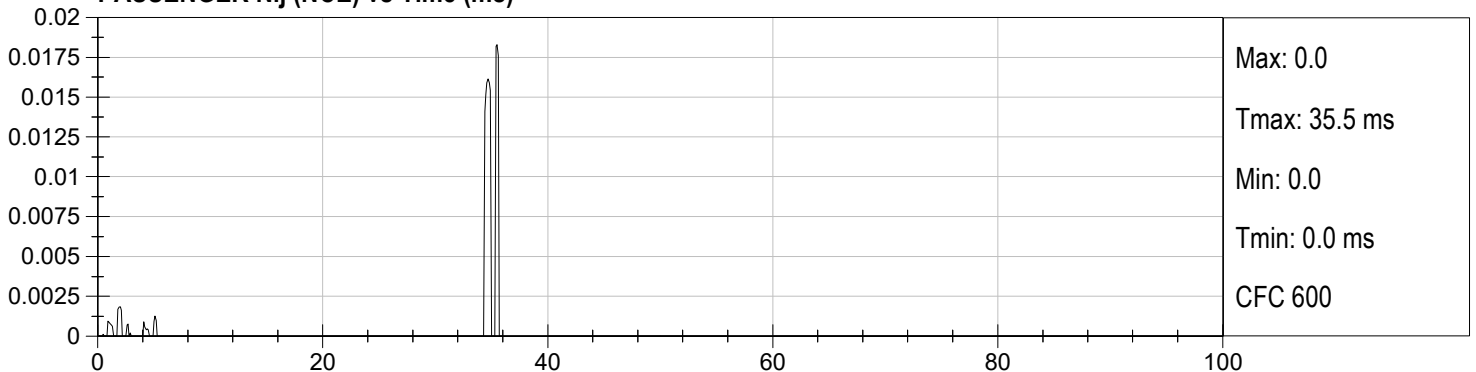

Injury Values Calculated between 0ms and 100ms

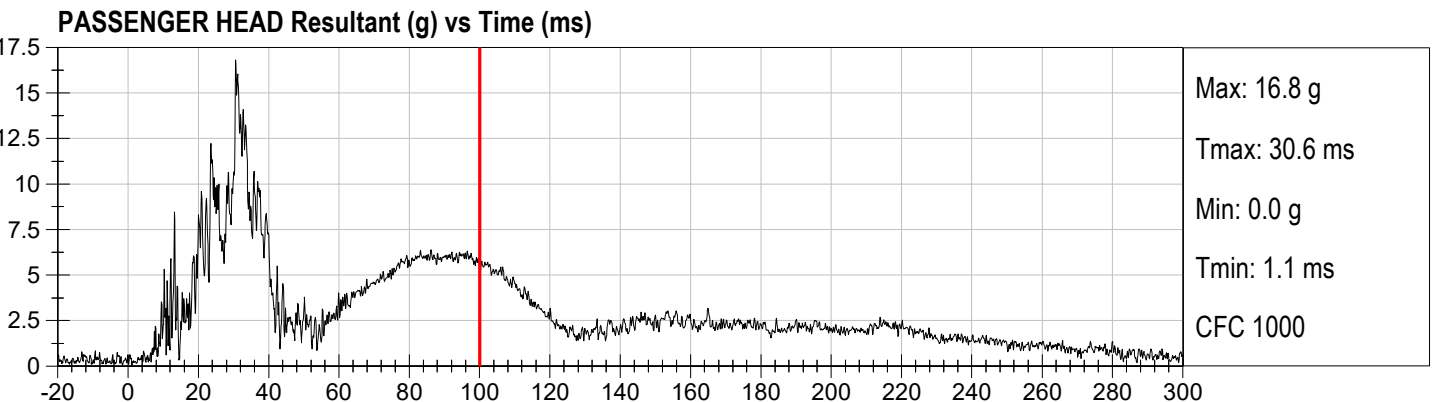
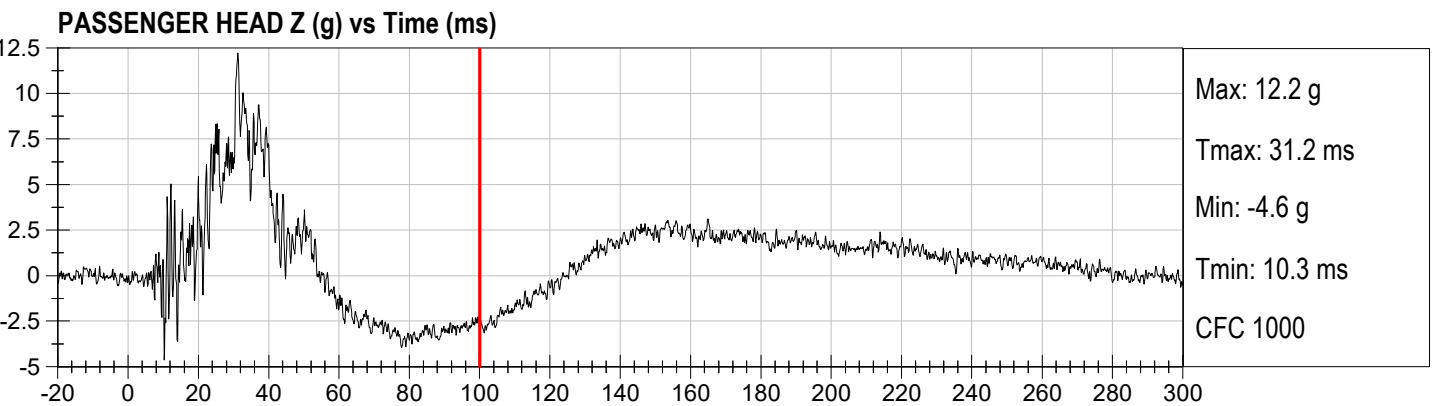
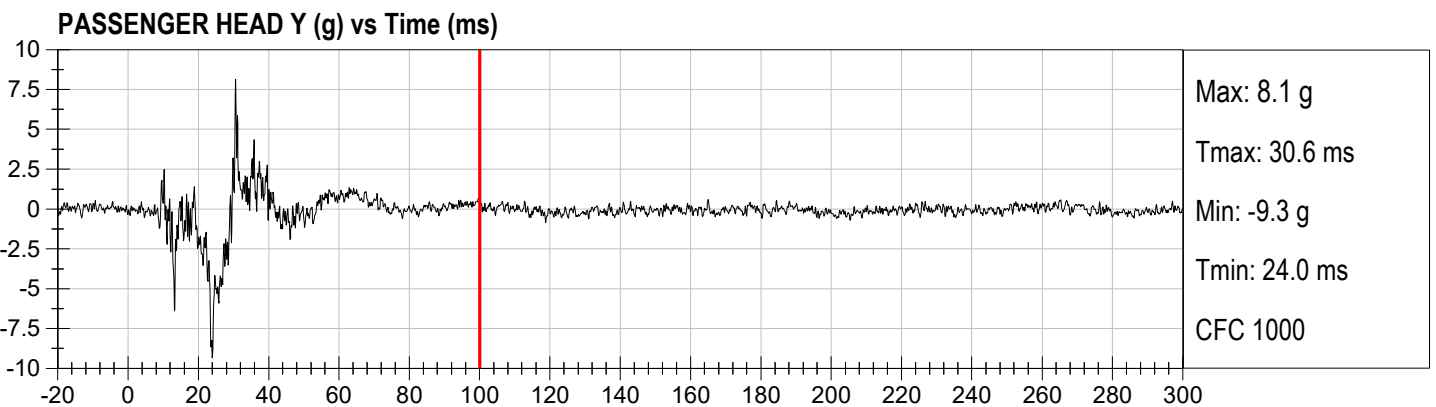
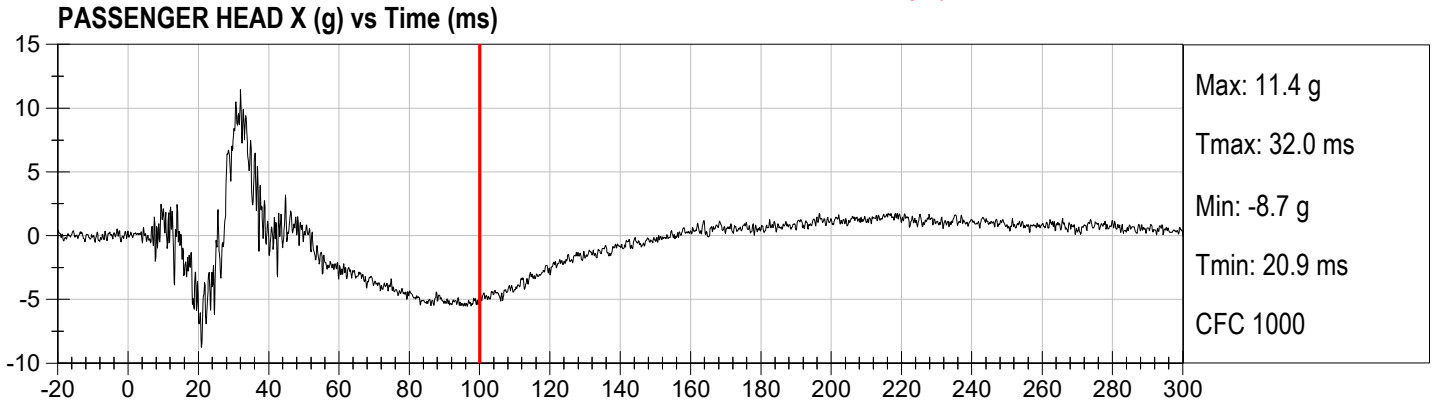

Injury Values Calculated between 0ms and 100ms

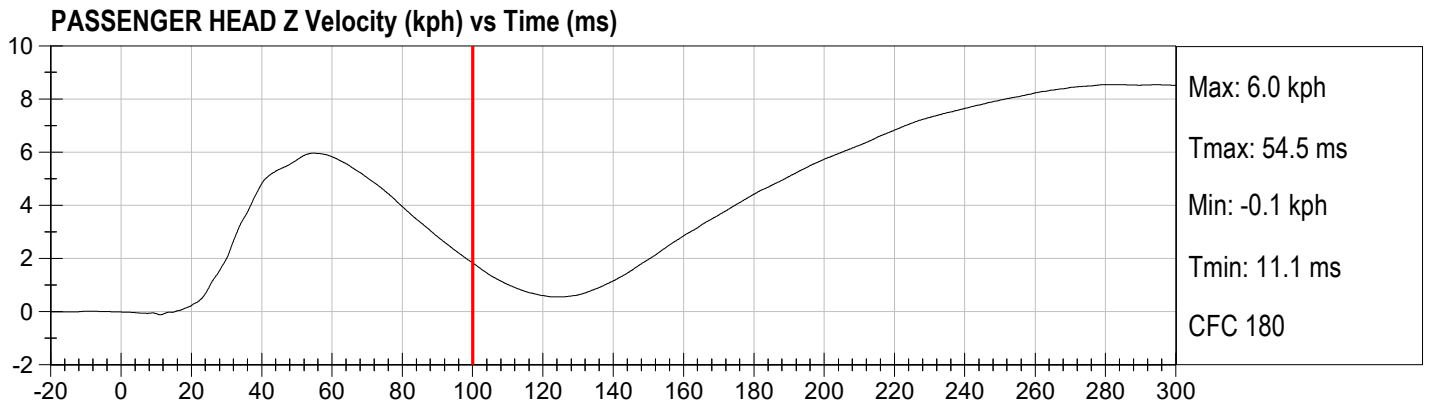
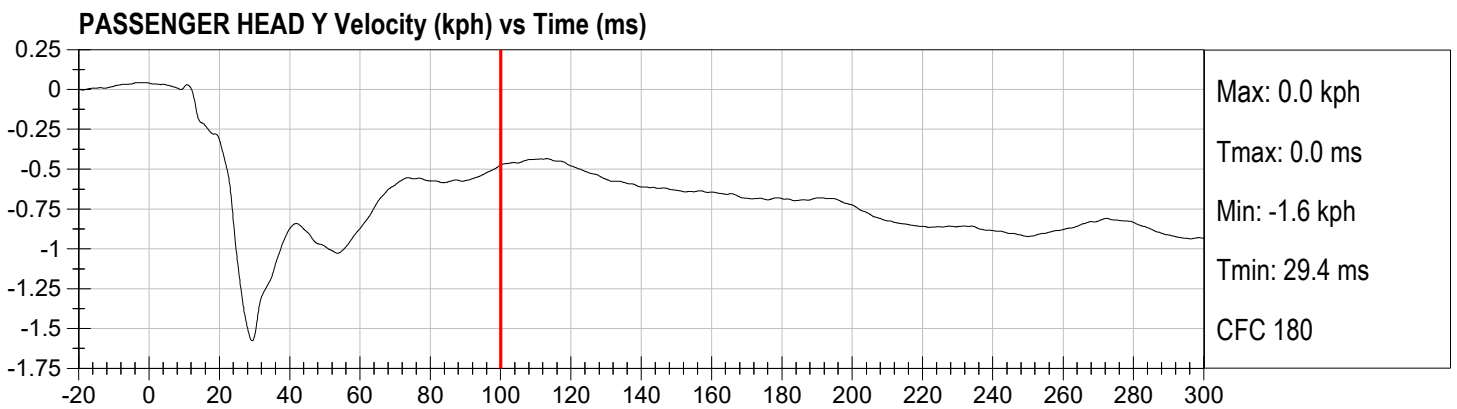
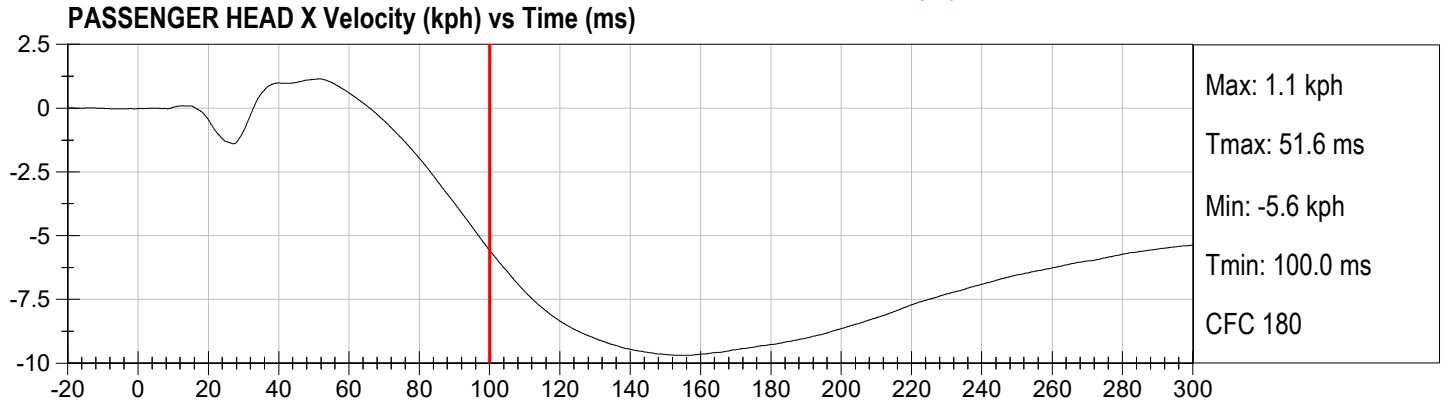

Injury Values Calculated between 0ms and 100ms

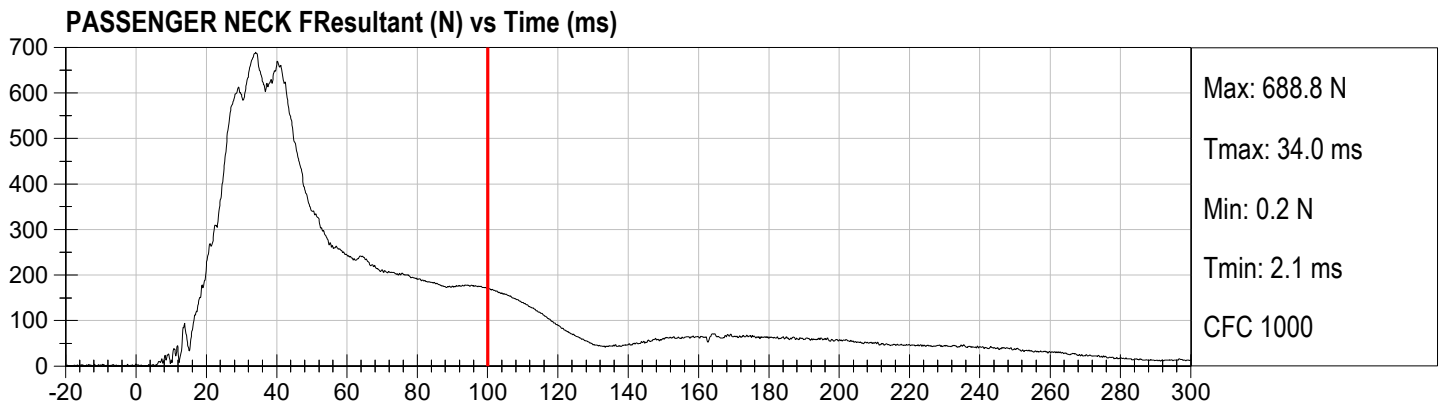
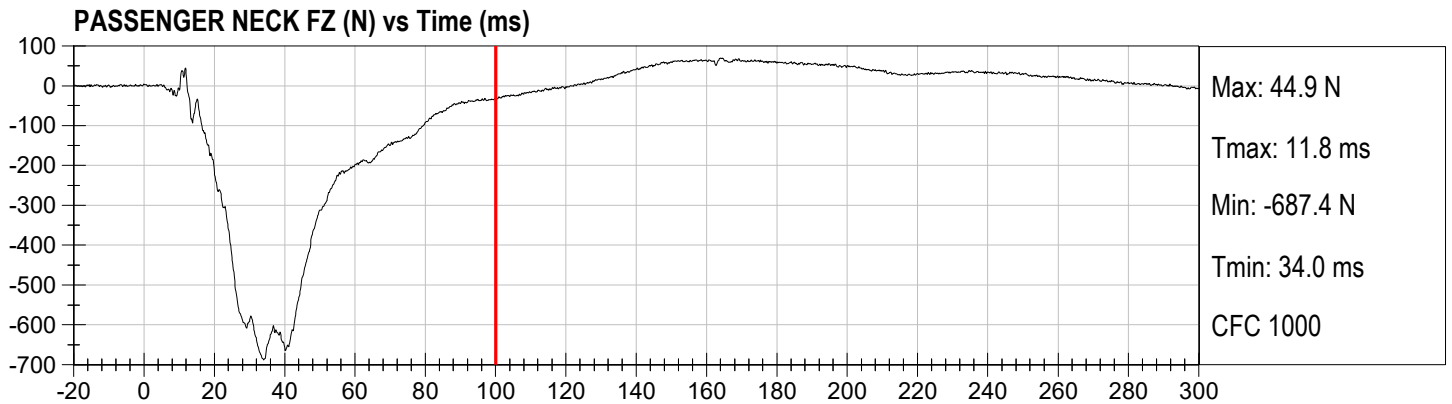
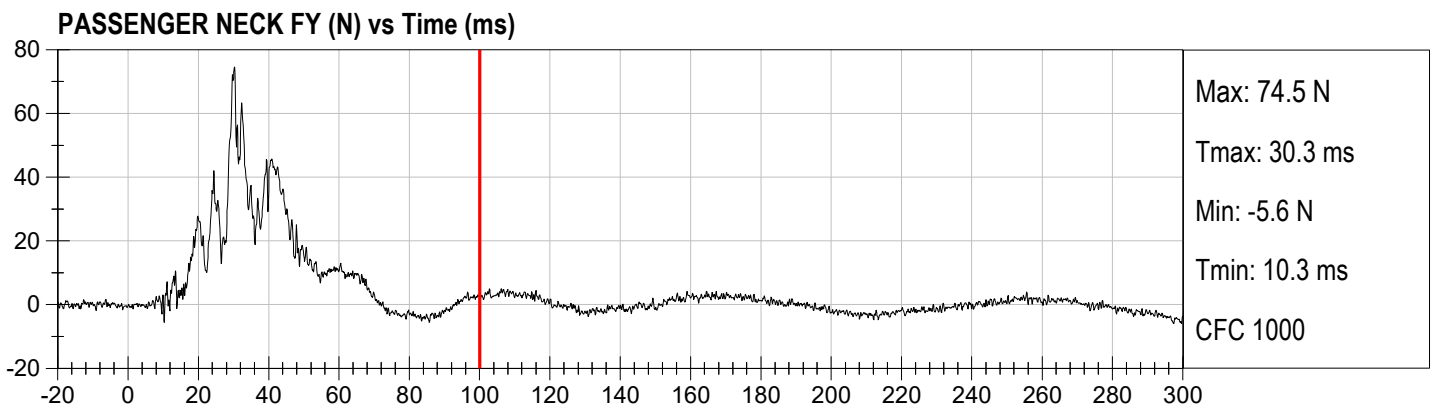
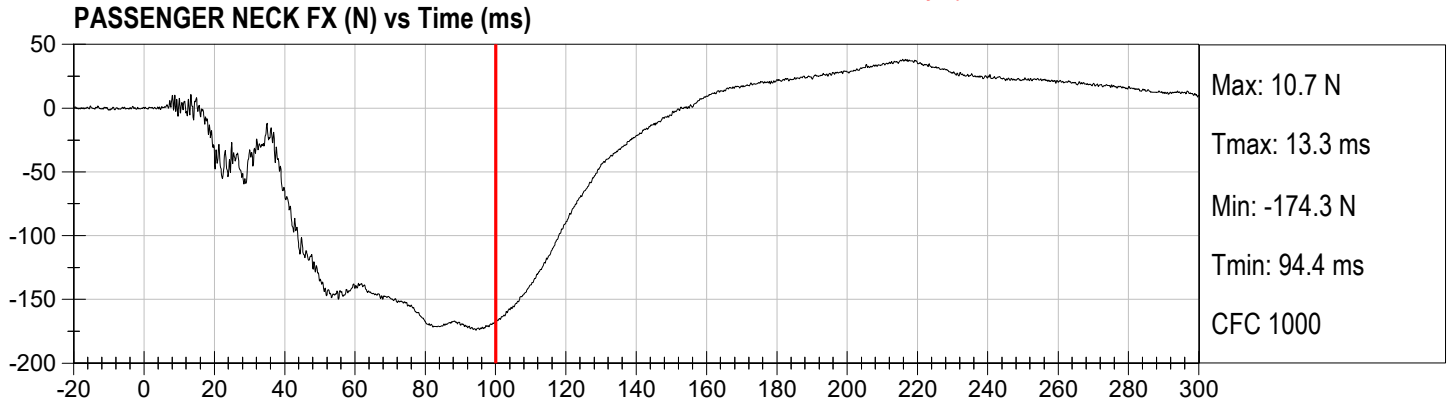

Injury Values Calculated between 0ms and 100ms

PASSENGER NECK MX (Nm) vs Time (ms)

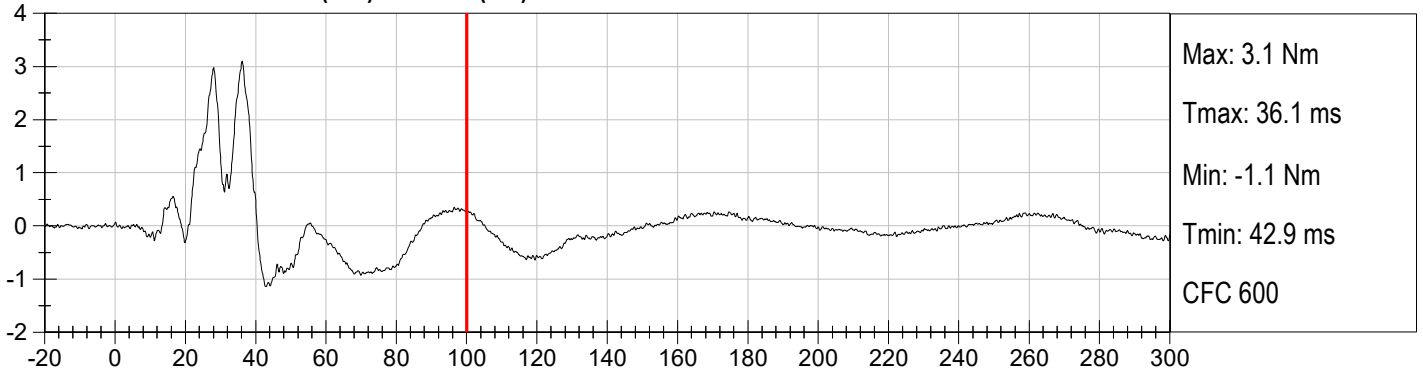

PASSENGER NECK MY (Nm) vs Time (ms)

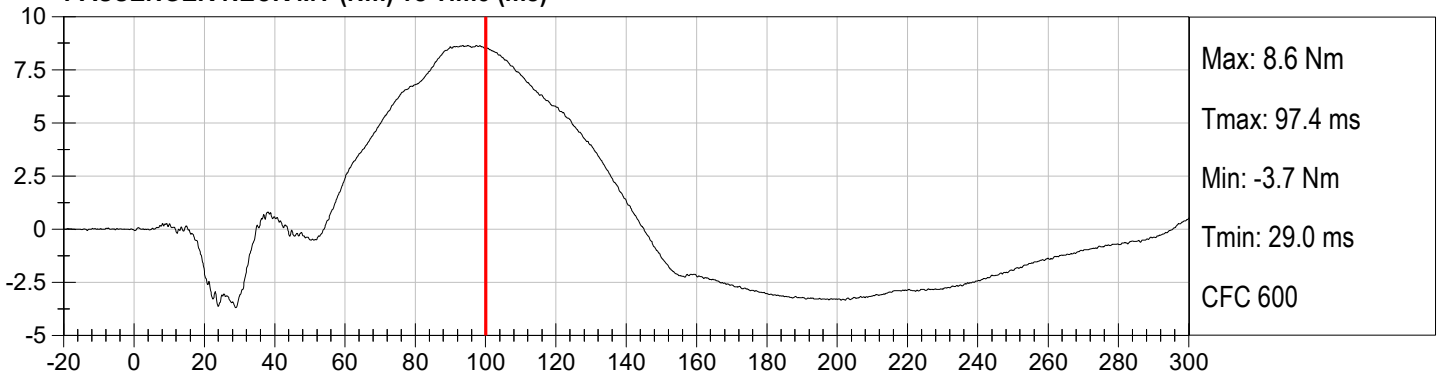

PASSENGER NECK MZ (Nm) vs Time (ms)

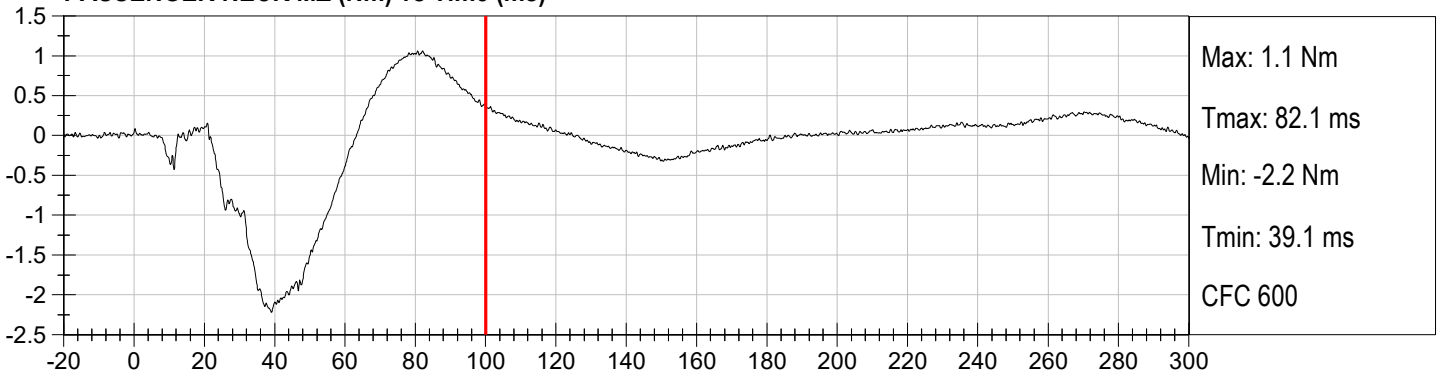

PASSENGER NECK MY Occipital Condyle (Nm) vs Time (ms)

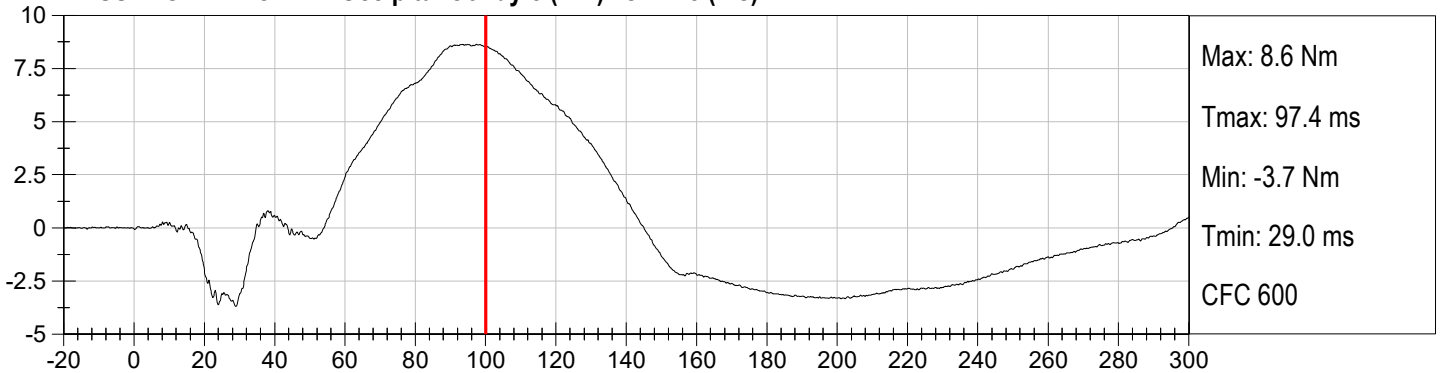

Injury Values Calculated between 0ms and 100ms

PASSENGER CHEST X (g) vs Time (ms)

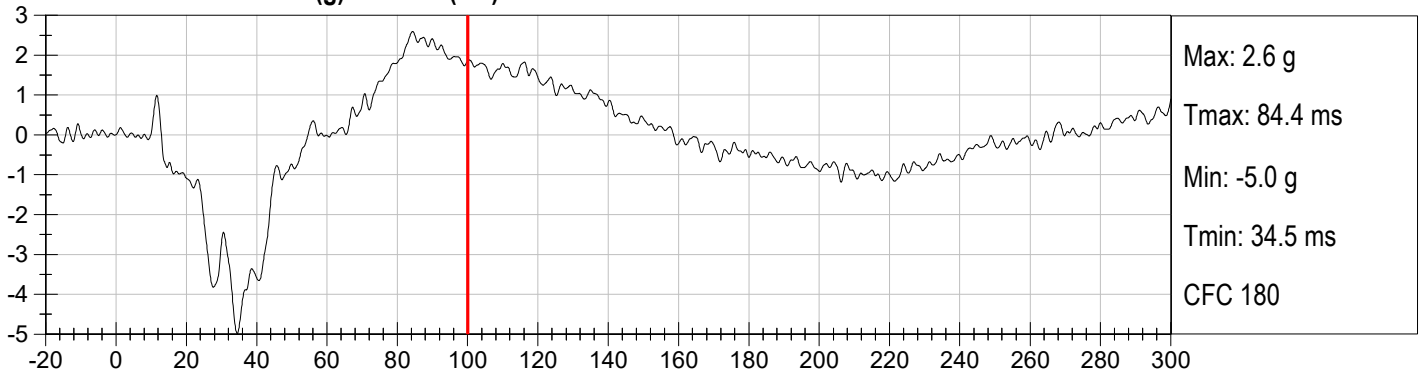

PASSENGER CHEST Y (g) vs Time (ms)

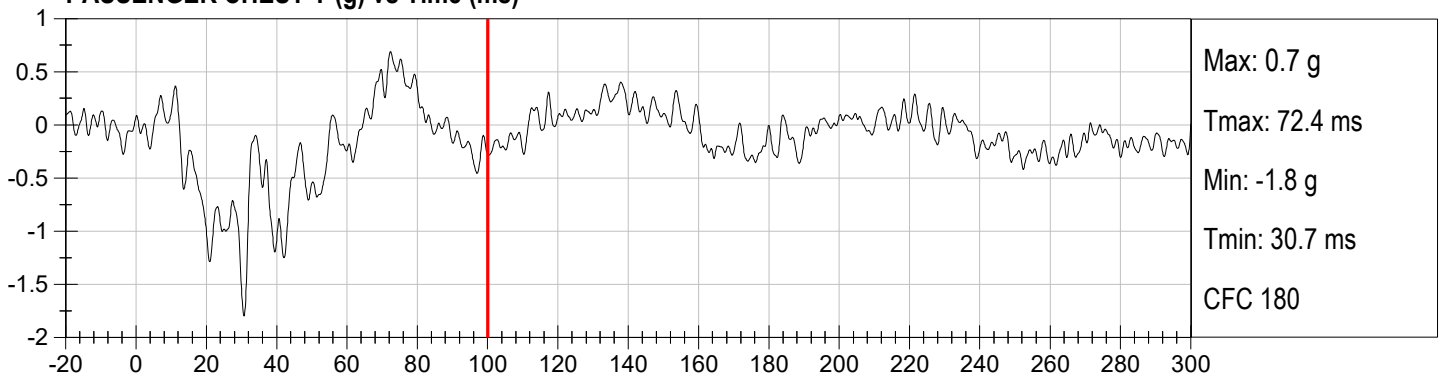

PASSENGER CHEST Z (g) vs Time (ms)

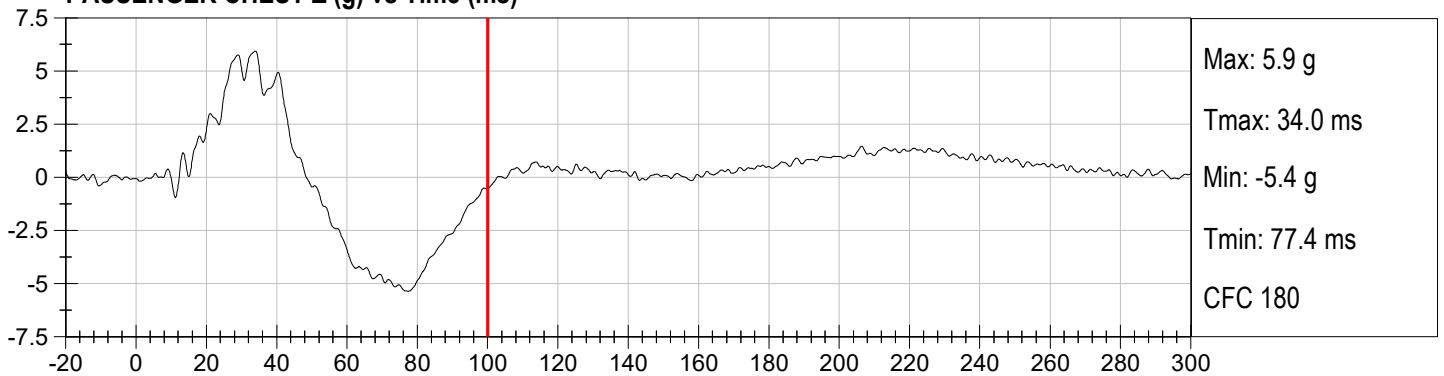

PASSENGER CHEST Resultant (g) vs Time (ms)

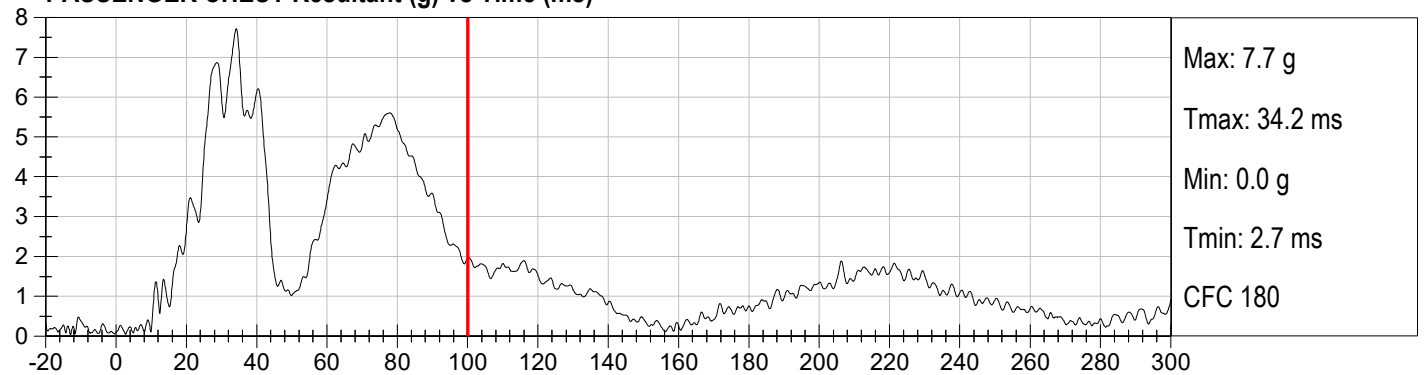

Injury Values Calculated between 0ms and 100ms

PASSENGER CHEST X Velocity (kph) vs Time (ms)

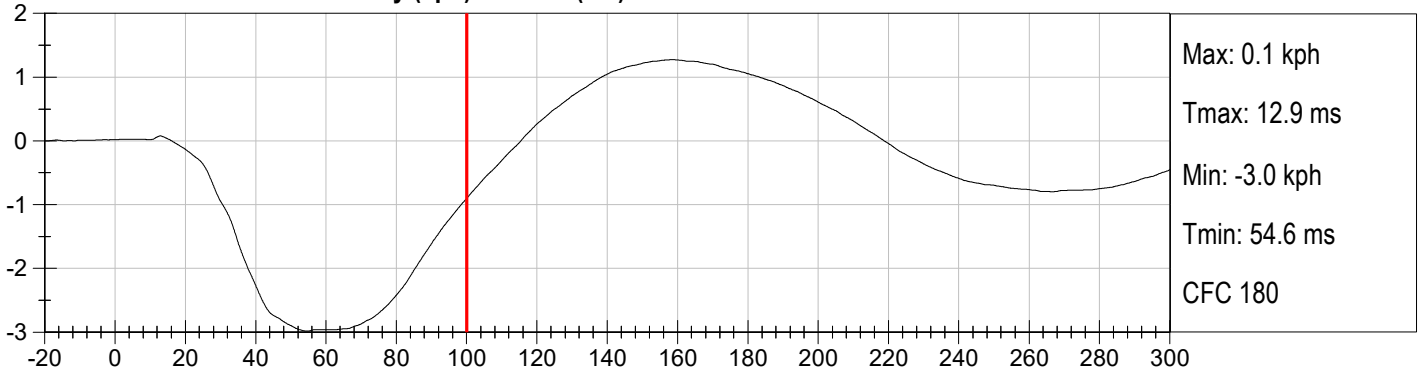

PASSENGER CHEST Y Velocity (kph) vs Time (ms)

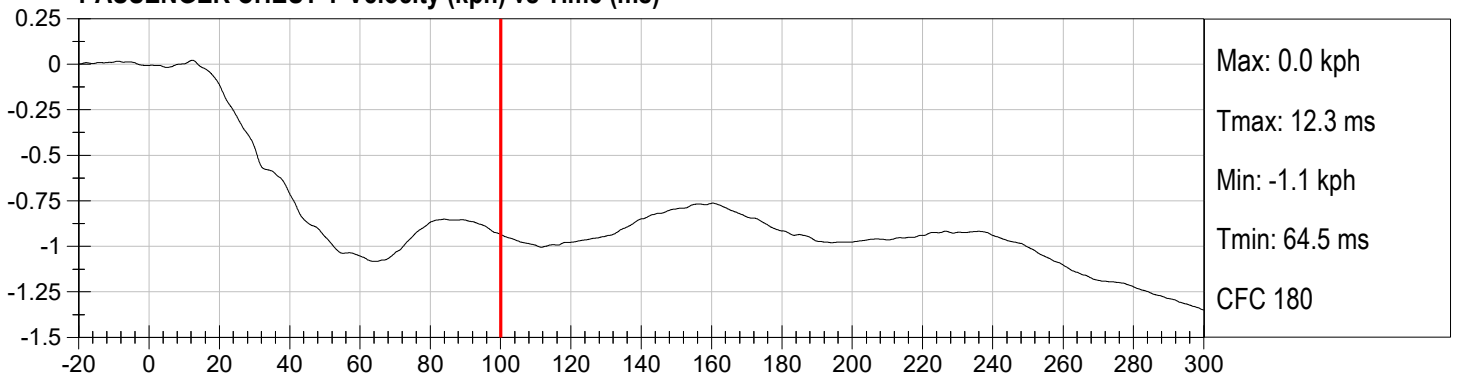

PASSENGER CHEST Z Velocity (kph) vs Time (ms)

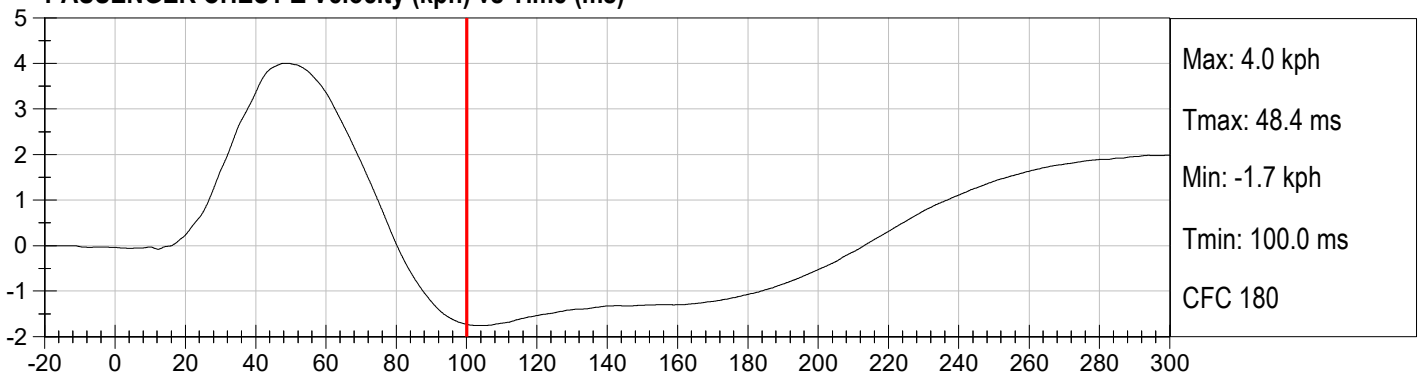

PASSENGER CHEST DISPLACEMENT (mm) vs Time (ms)

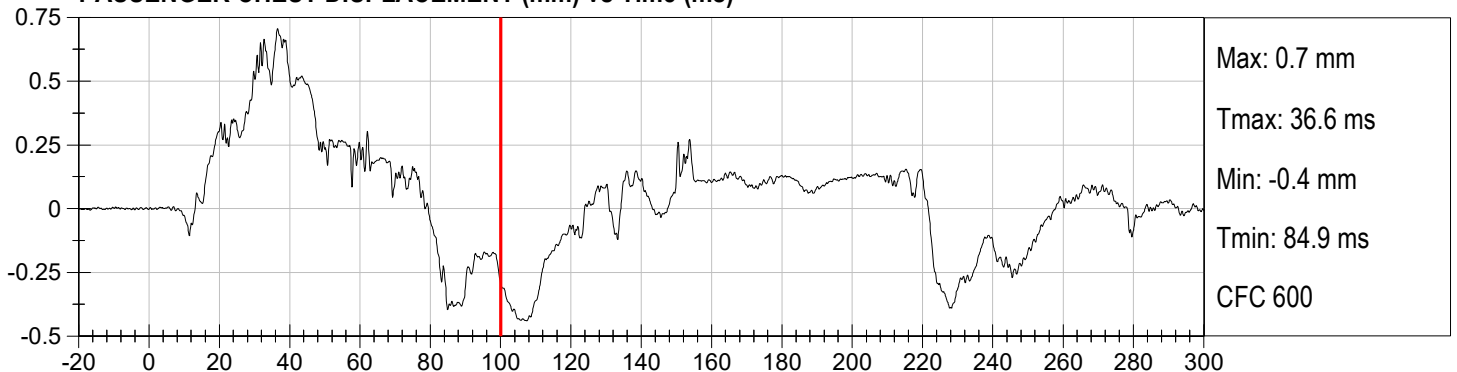

Injury Values Calculated between 0ms and 100ms

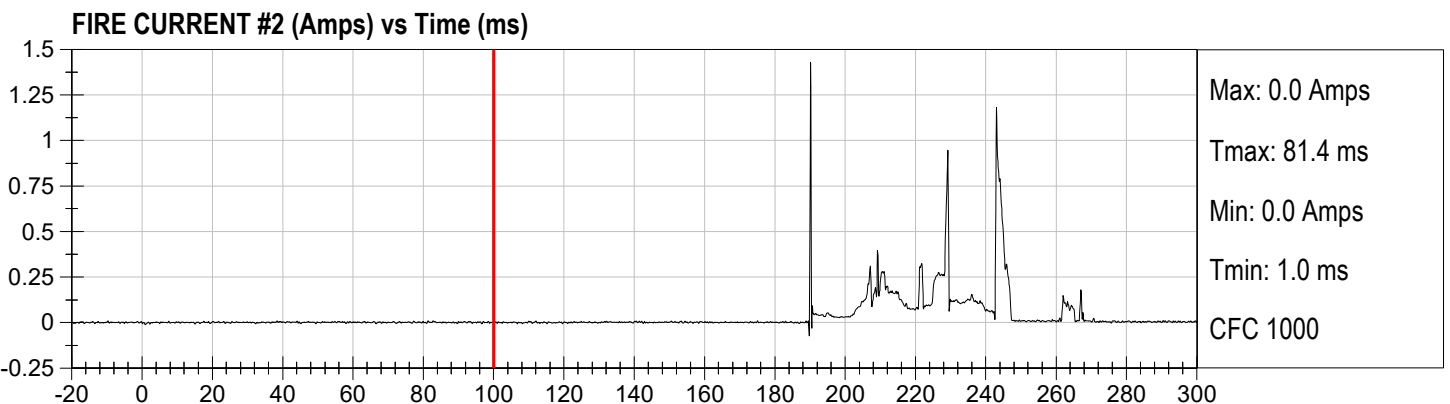
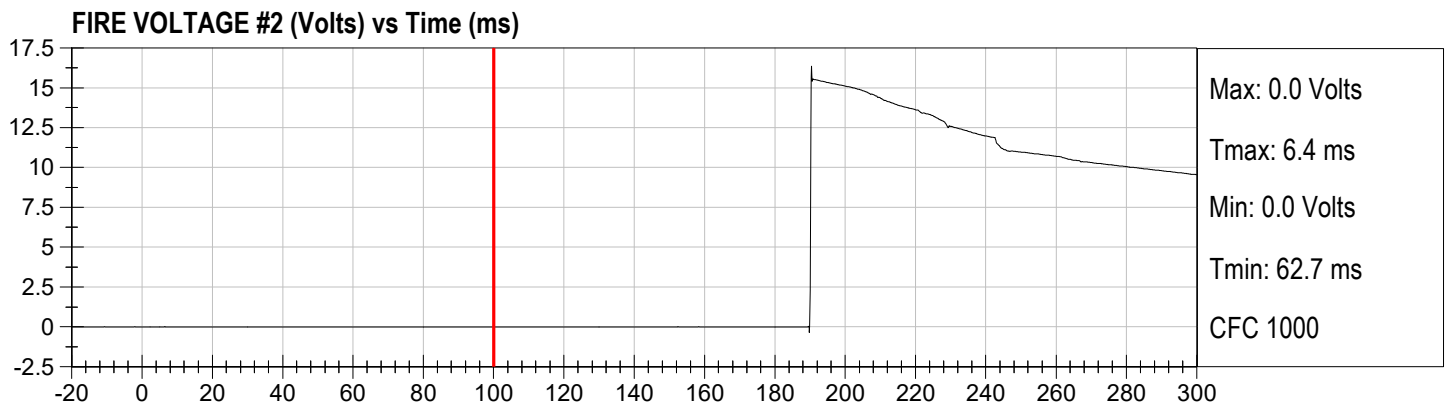
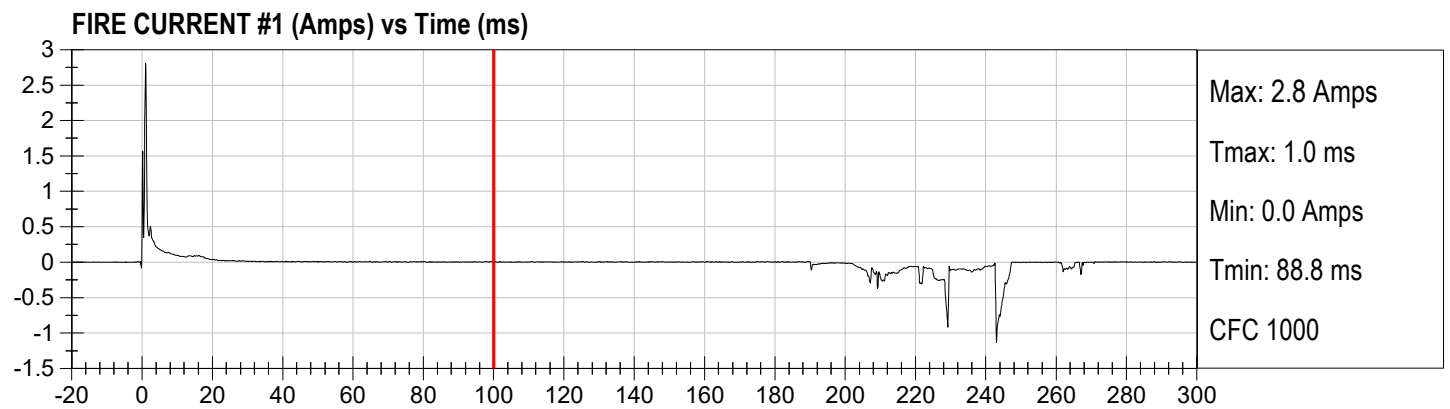

Injury Values Calculated between 0ms and 100ms

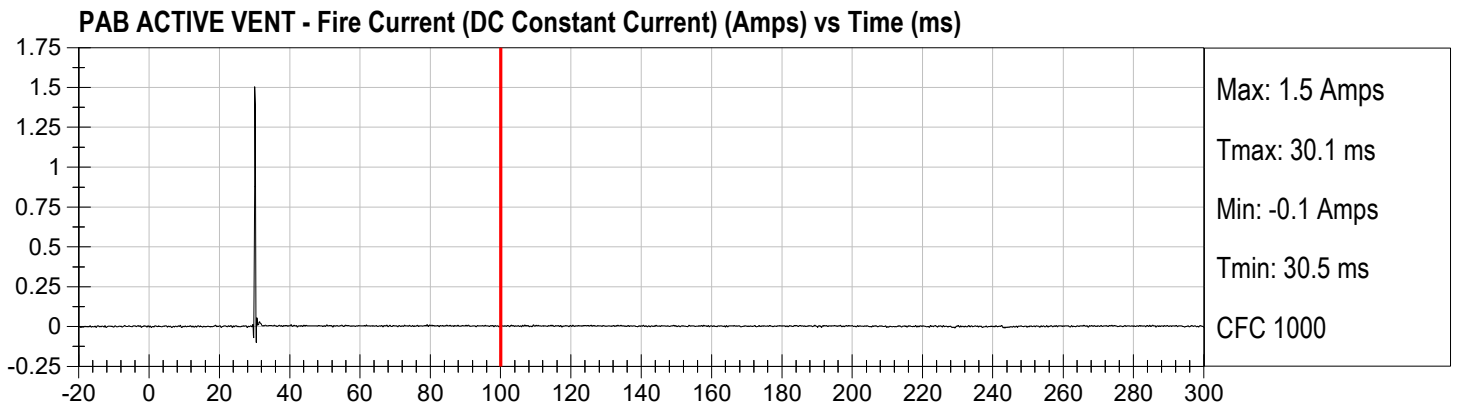
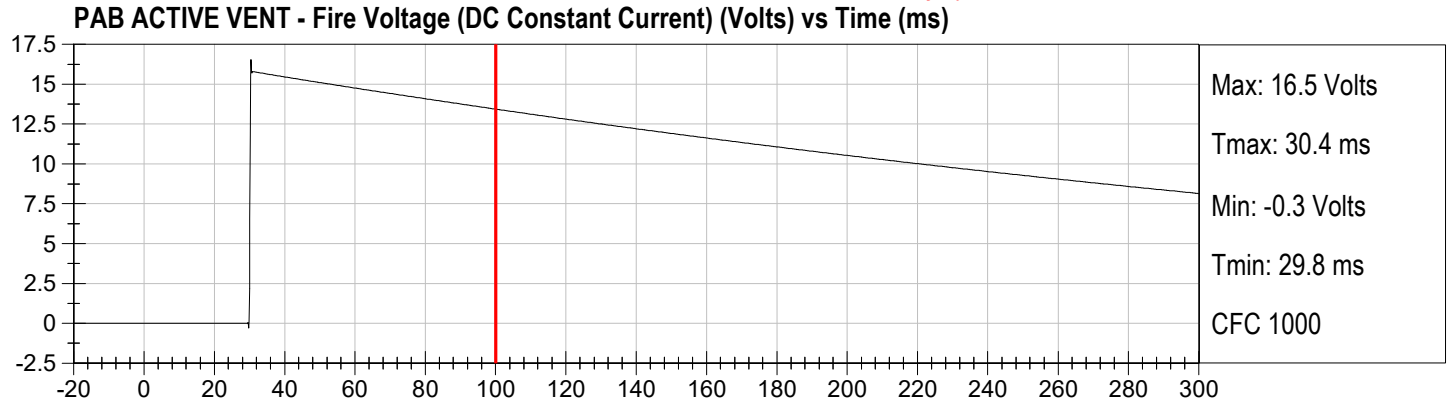

Injury Values Calculated between 0ms and 100ms

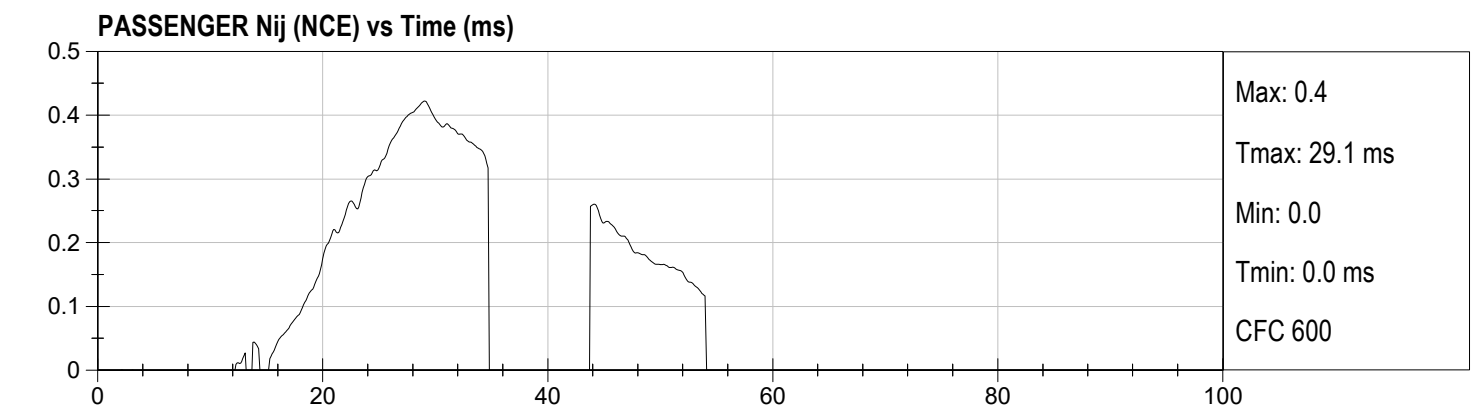
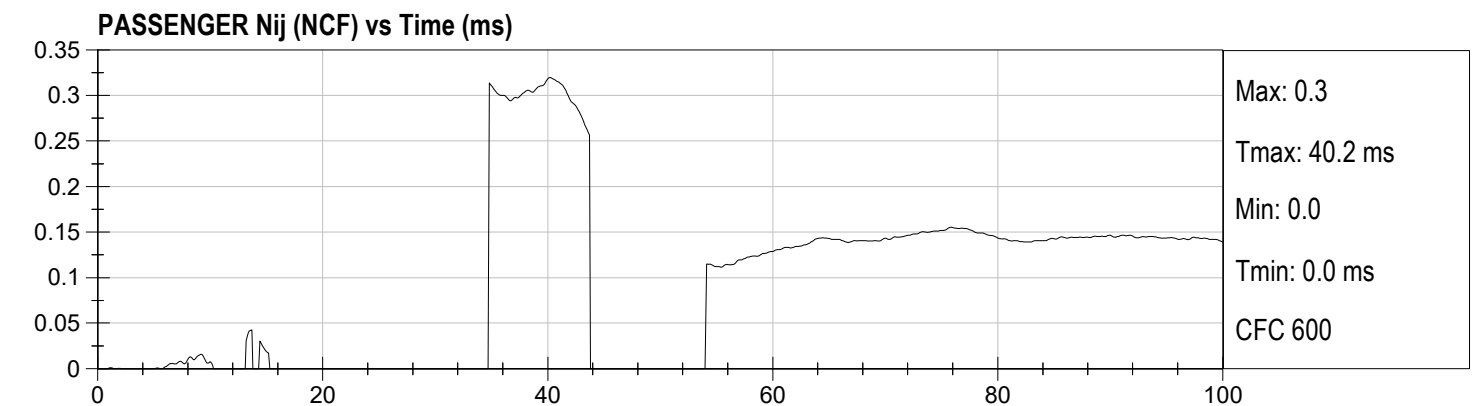
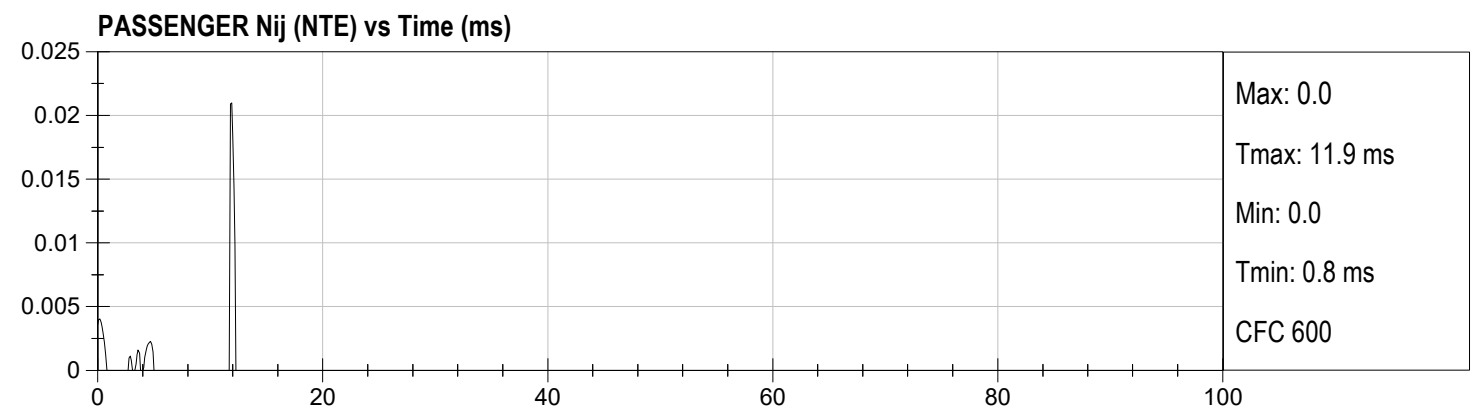
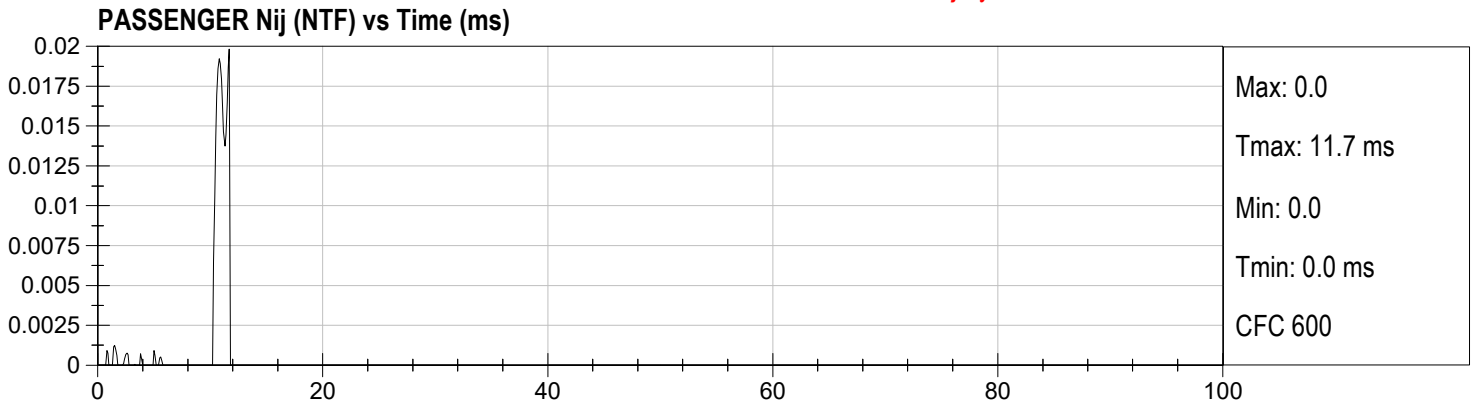

Injury Values Calculated between 0ms and 100ms

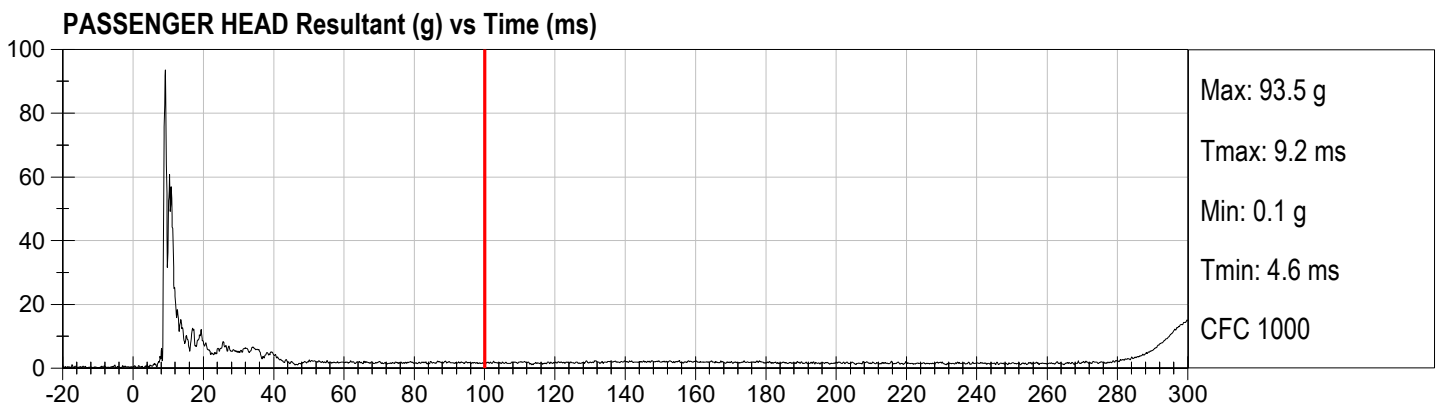
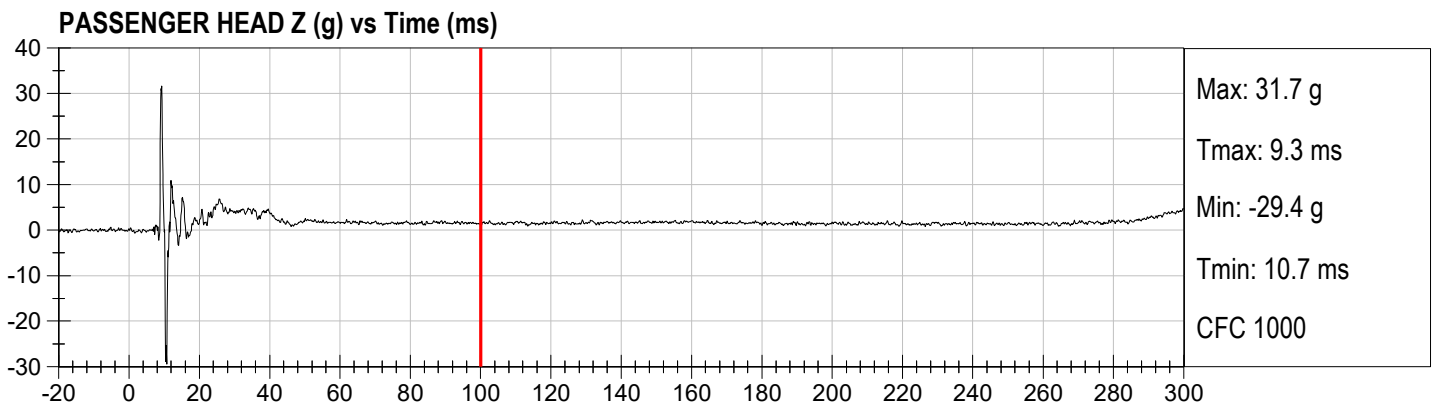
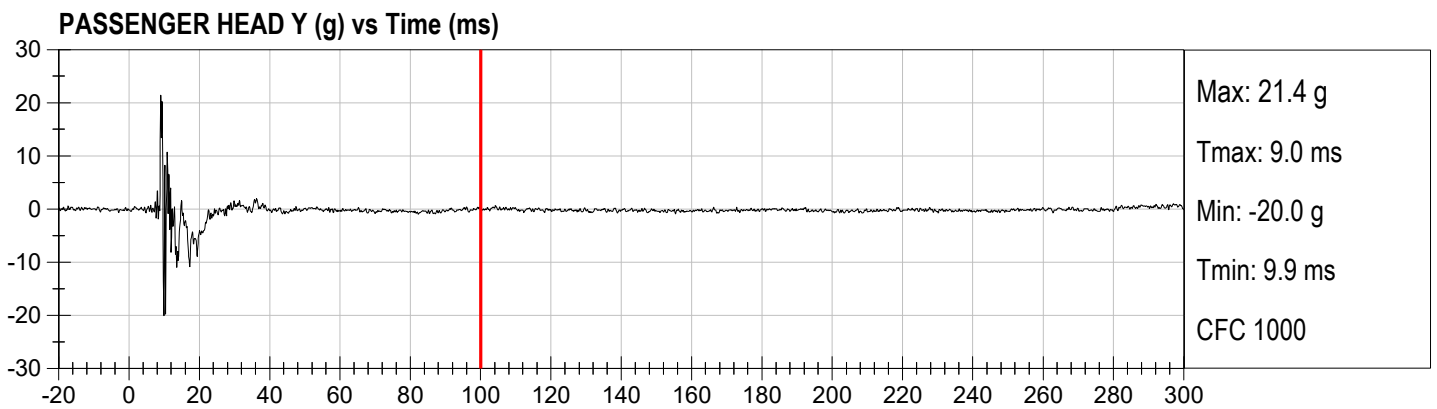
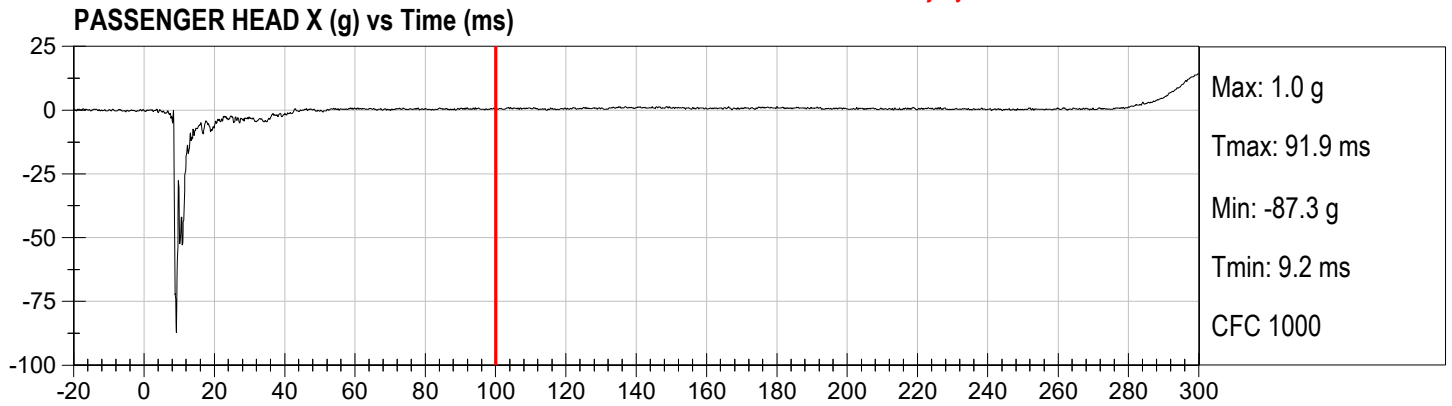

Injury Values Calculated between 0ms and 100ms

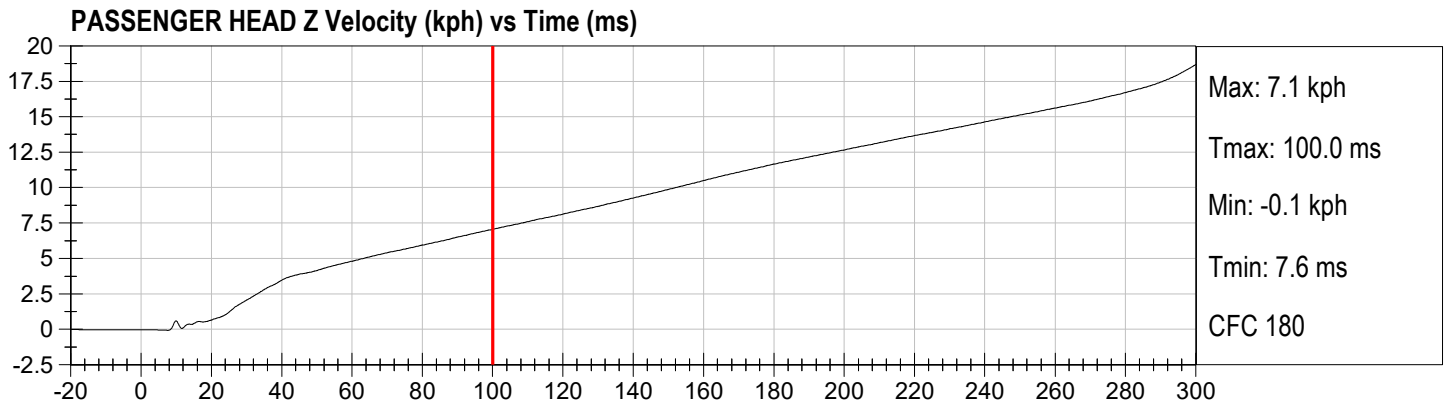
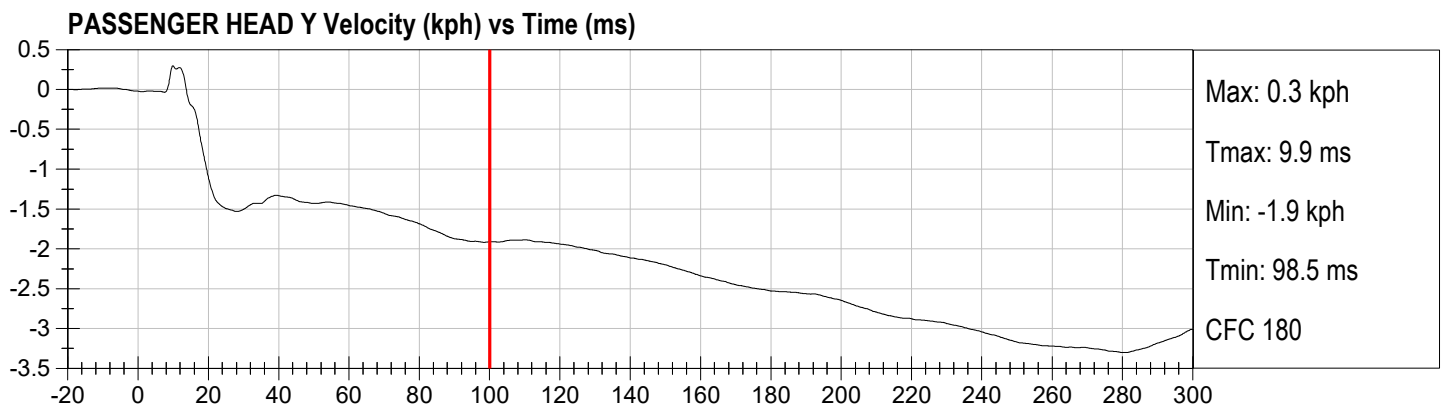
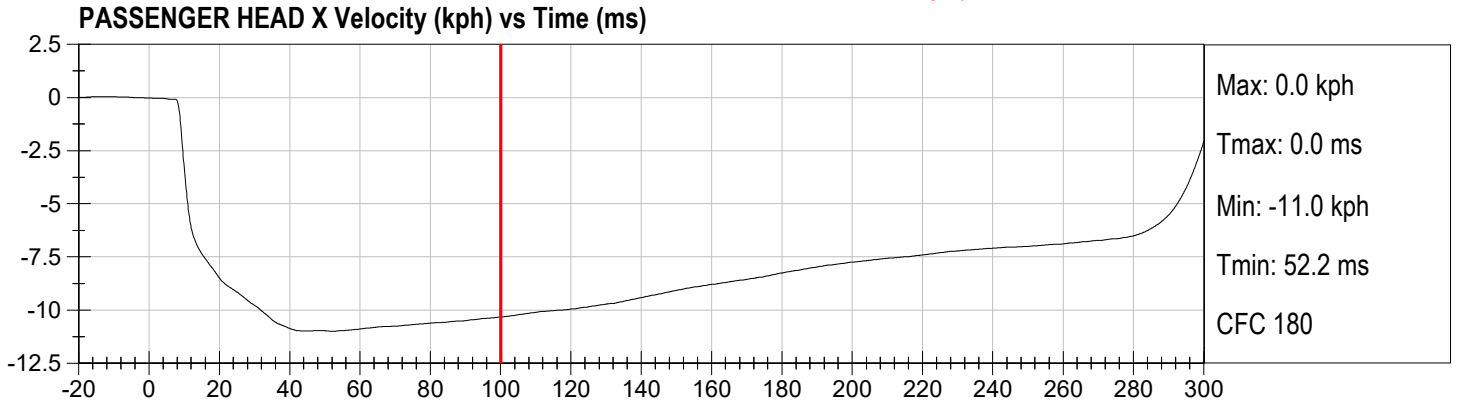

Injury Values Calculated between 0ms and 100ms

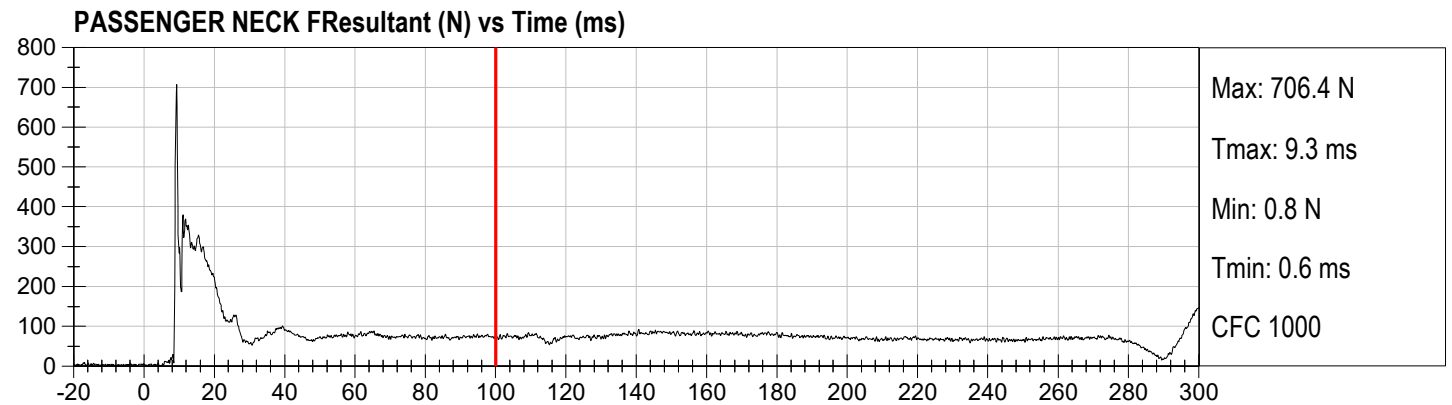
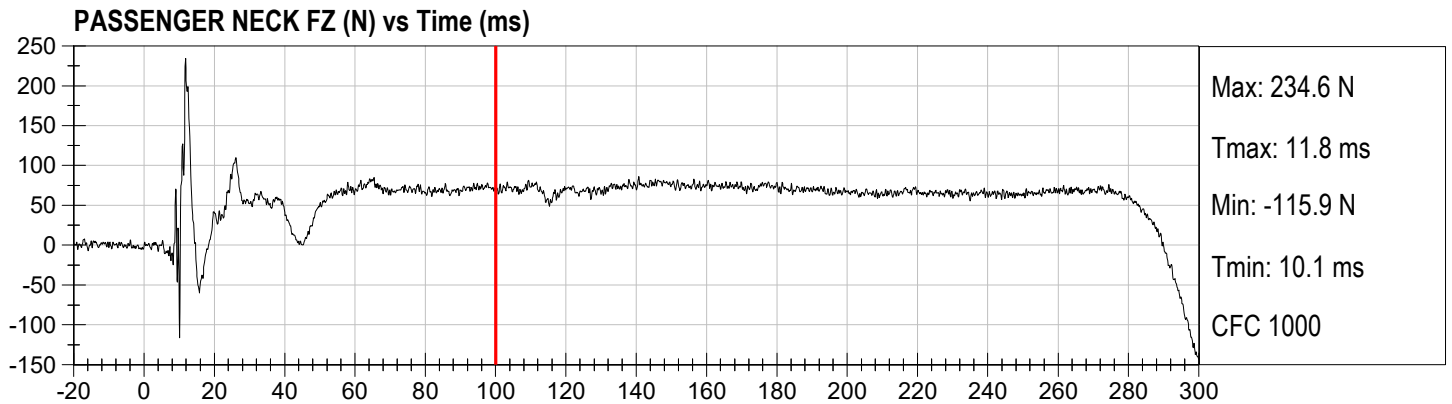
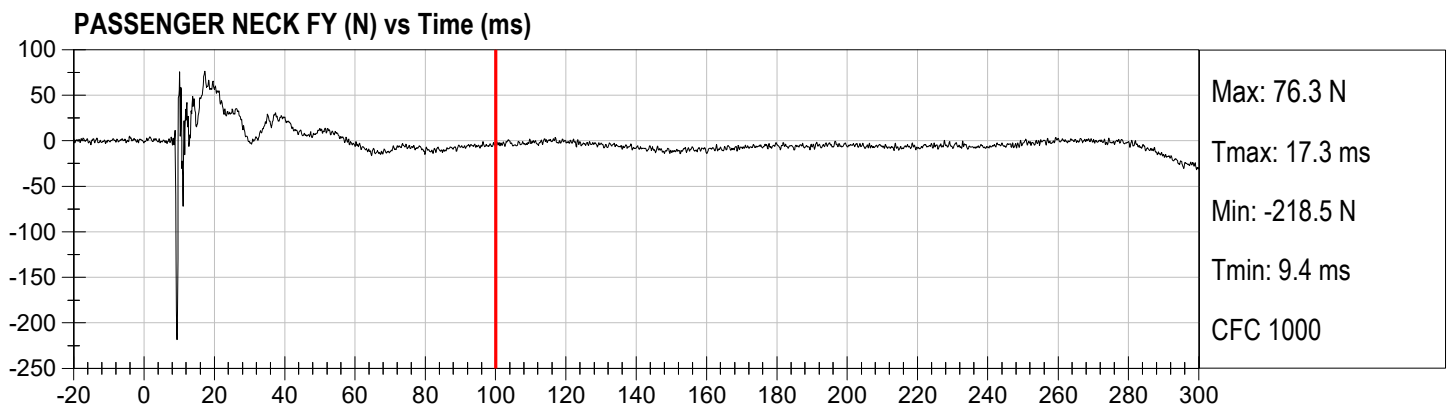
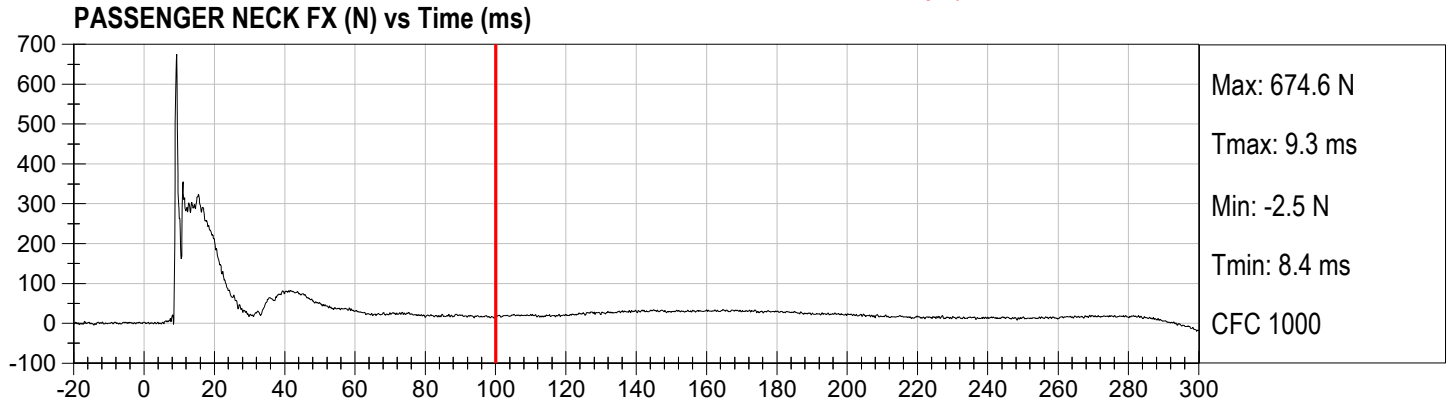

Injury Values Calculated between 0ms and 100ms

PASSENGER NECK MX (Nm) vs Time (ms)

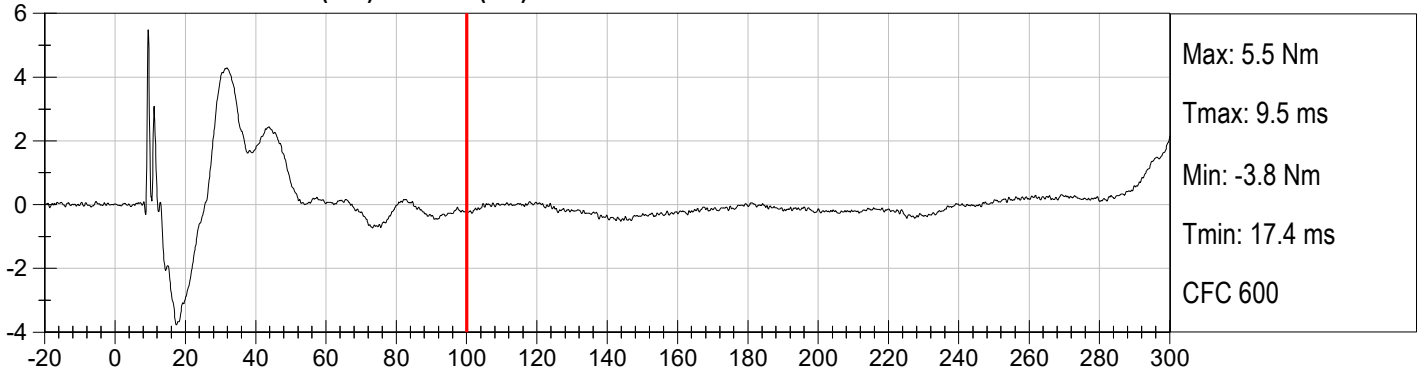

PASSENGER NECK MY (Nm) vs Time (ms)

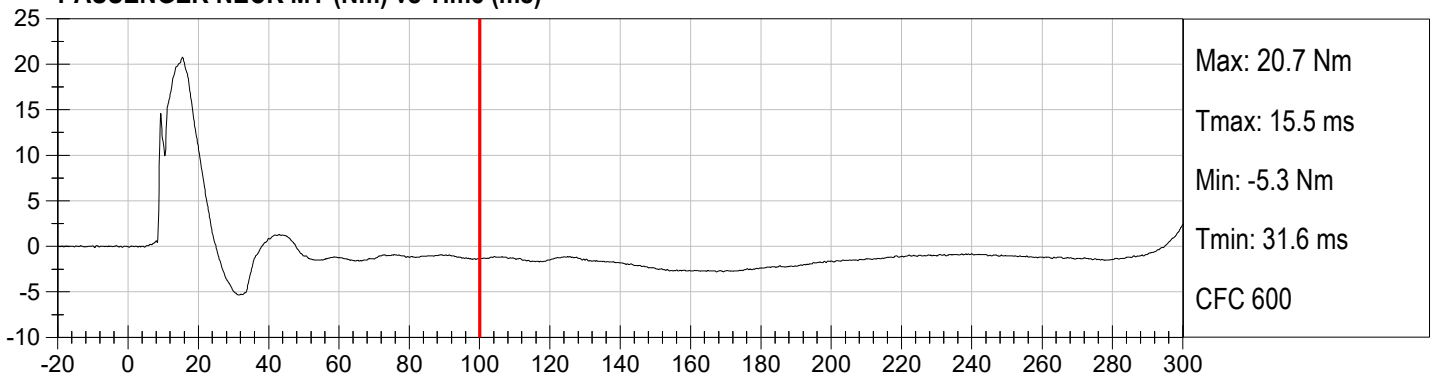

PASSENGER NECK MZ (Nm) vs Time (ms)

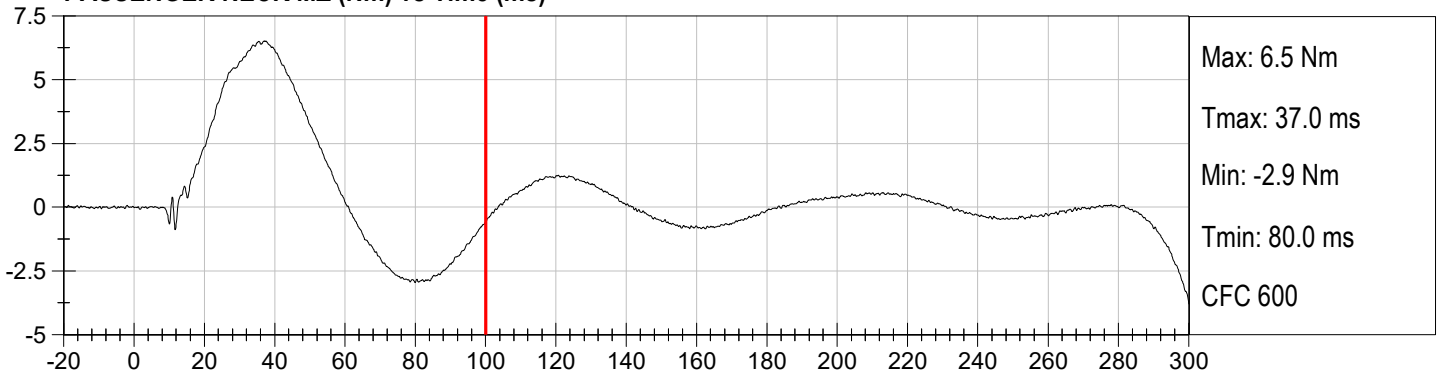

PASSENGER NECK MY Occipital Condyle (Nm) vs Time (ms)

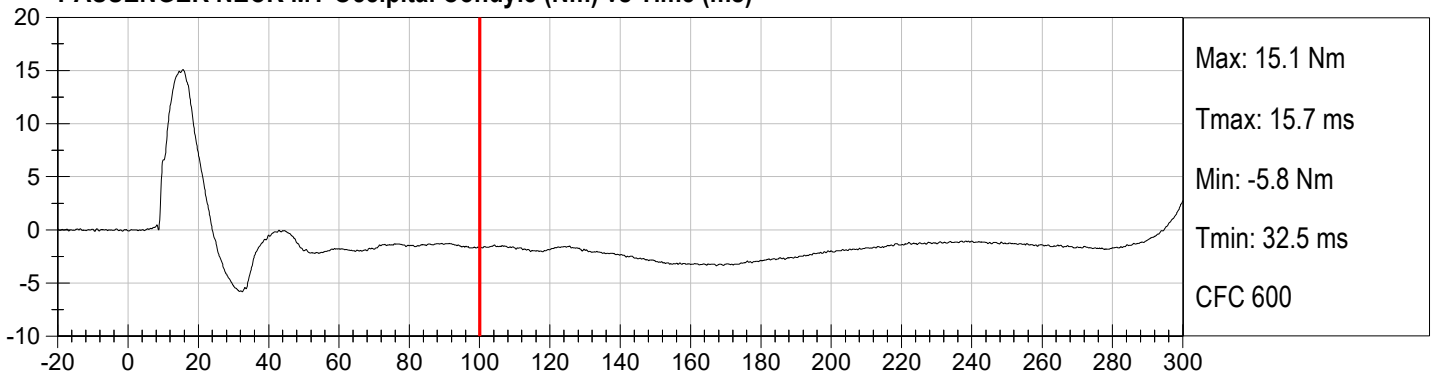

Injury Values Calculated between 0ms and 100ms

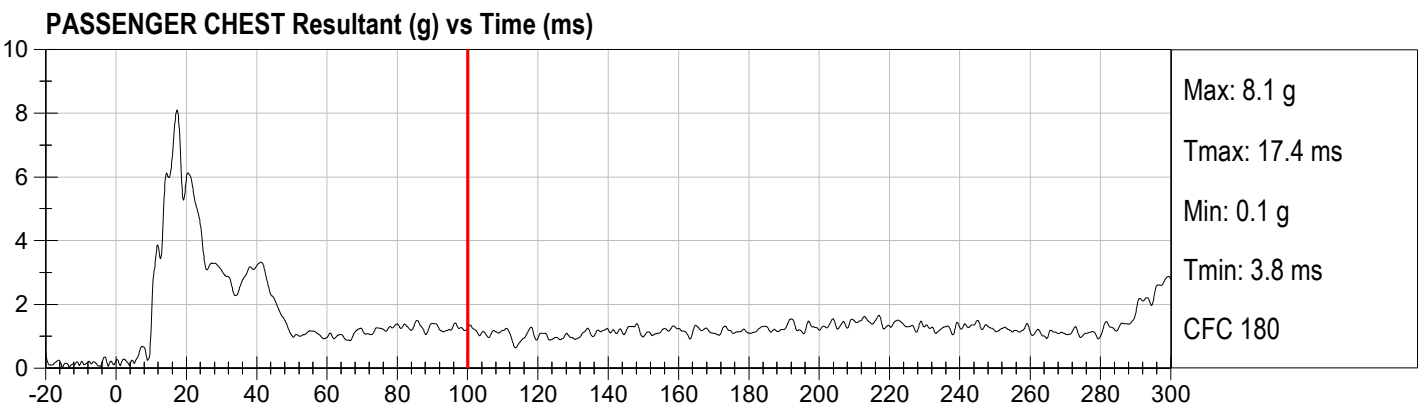
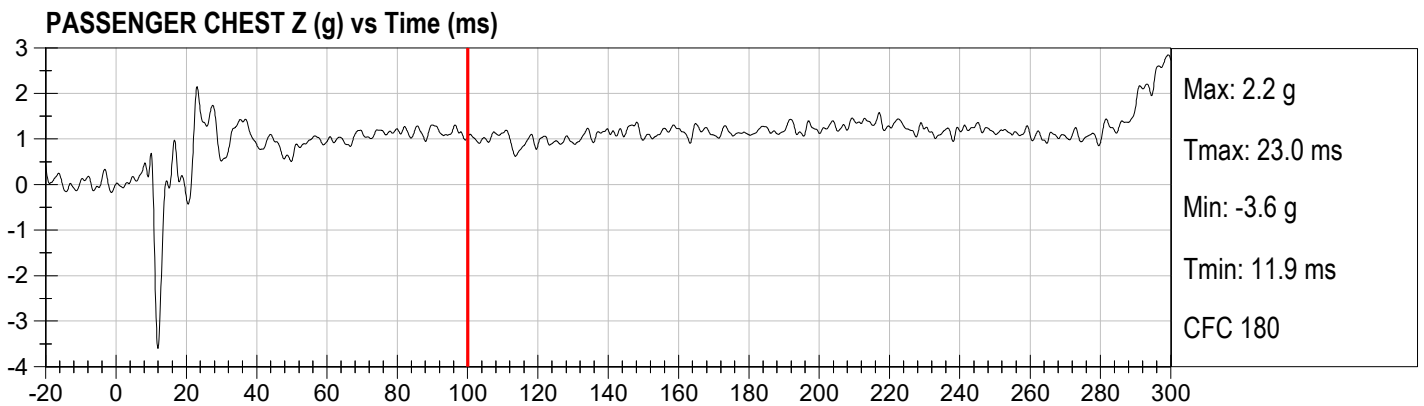
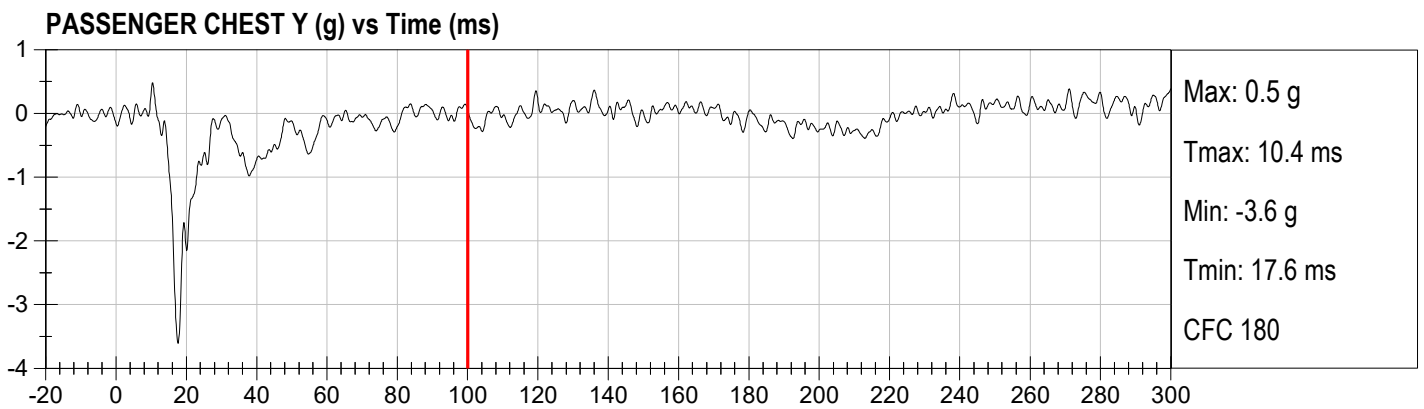
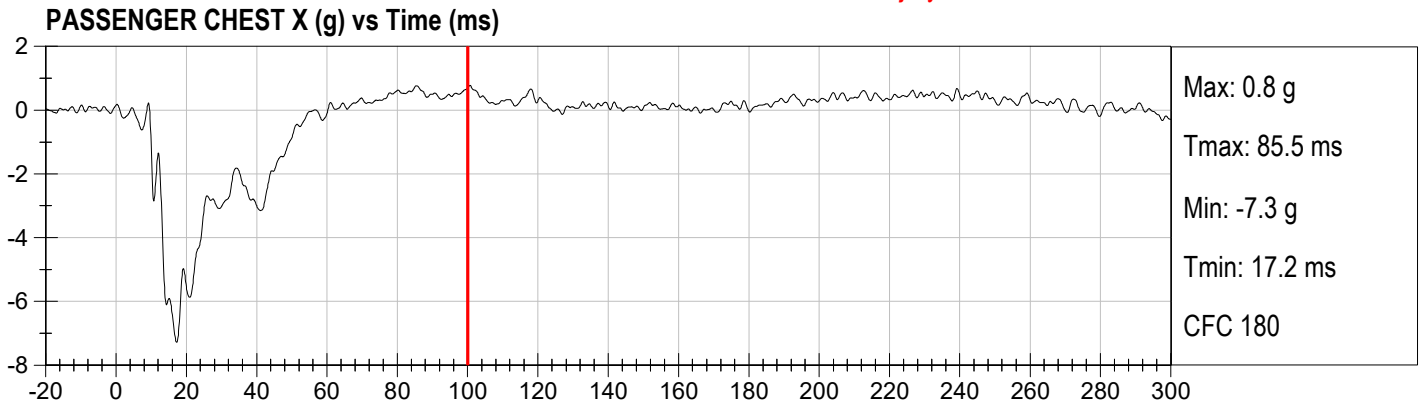

Injury Values Calculated between 0ms and 100ms

PASSENGER CHEST X Velocity (kph) vs Time (ms)

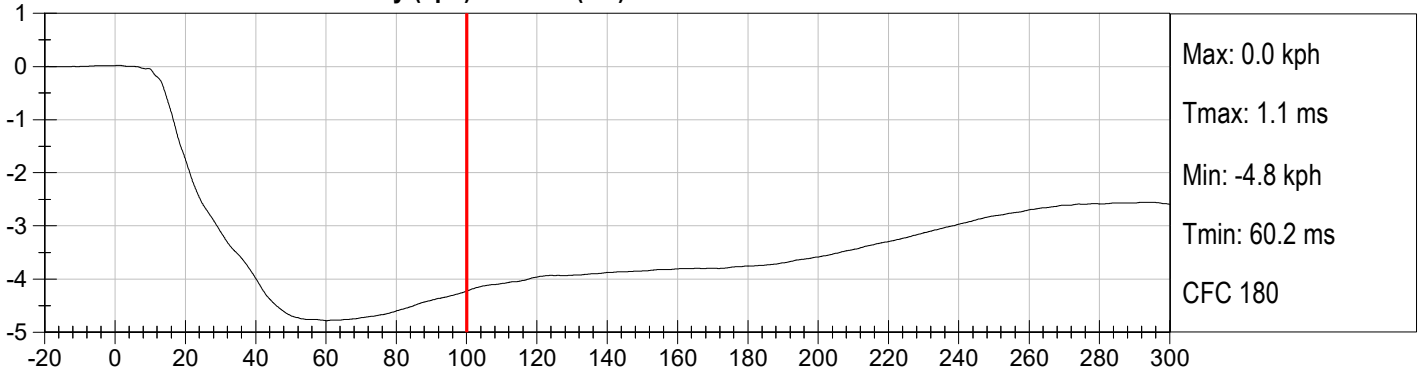

PASSENGER CHEST Y Velocity (kph) vs Time (ms)

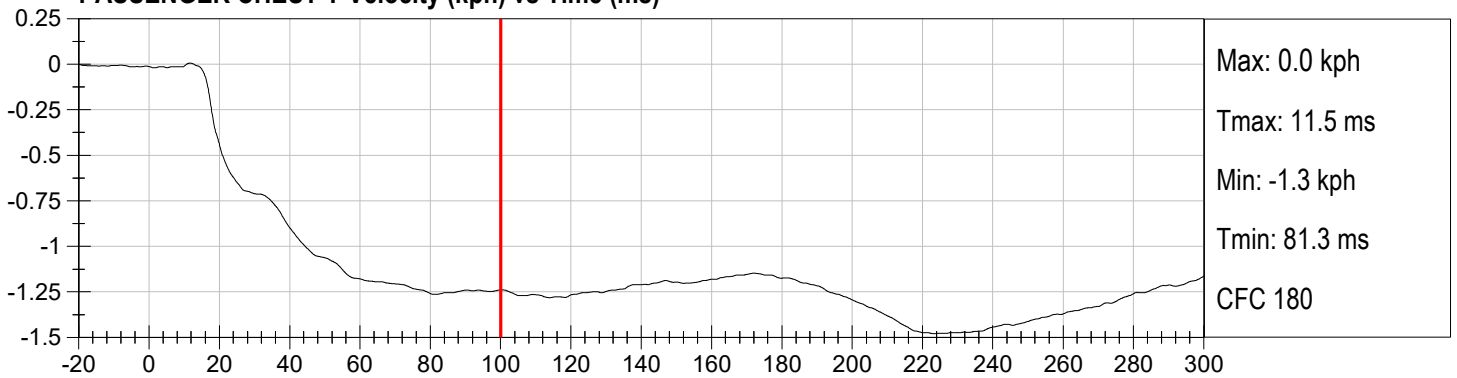

PASSENGER CHEST Z Velocity (kph) vs Time (ms)

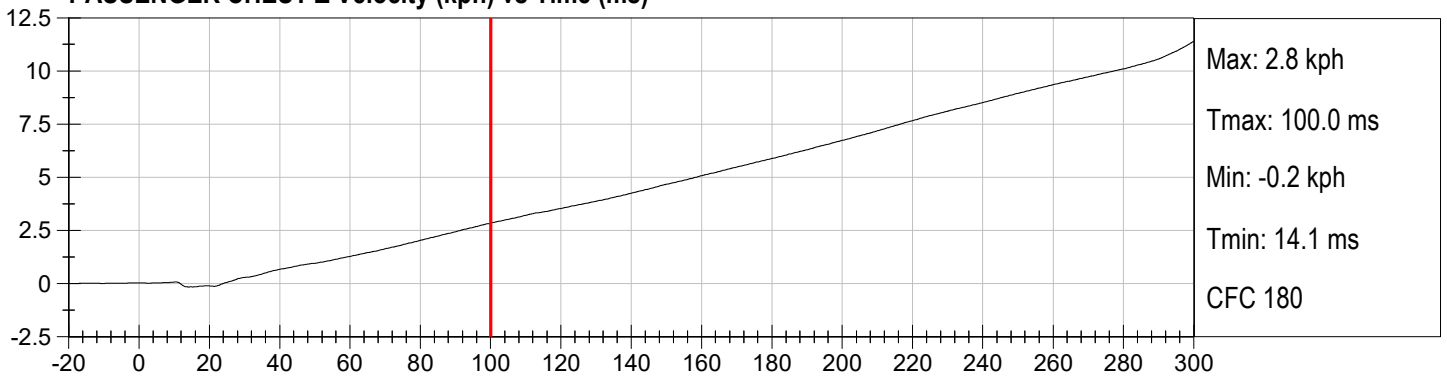

PASSENGER CHEST DISPLACEMENT (mm) vs Time (ms)

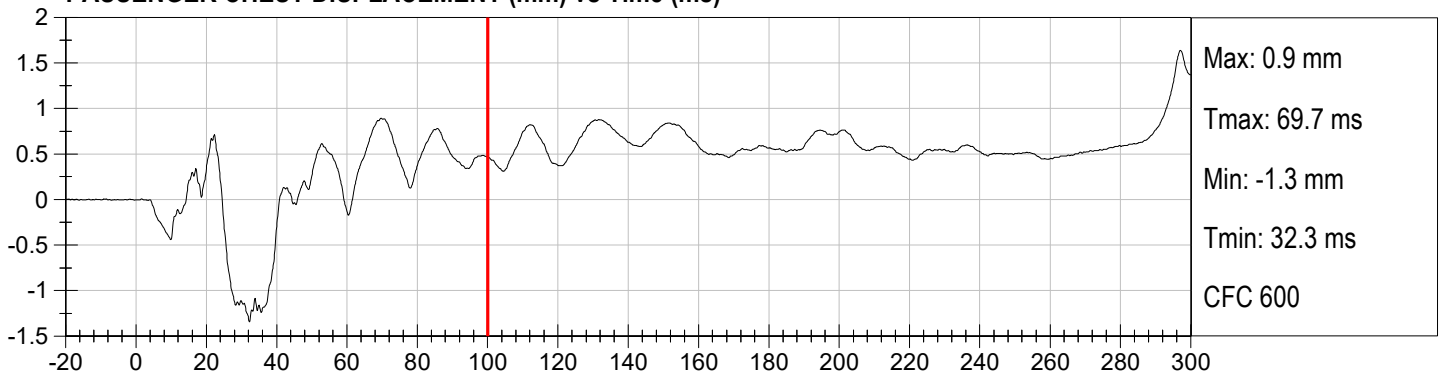

Injury Values Calculated between 0ms and 100ms

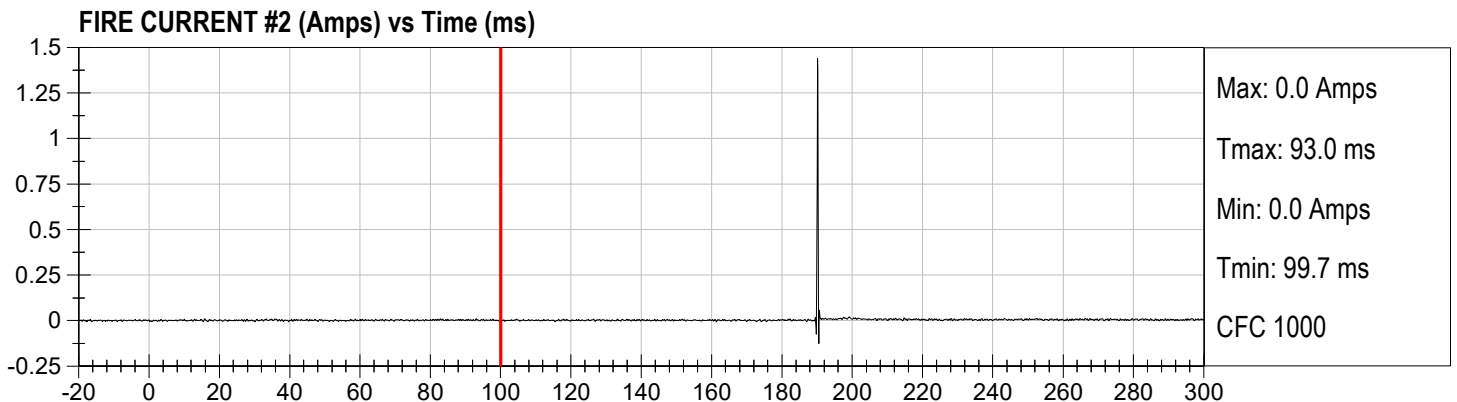
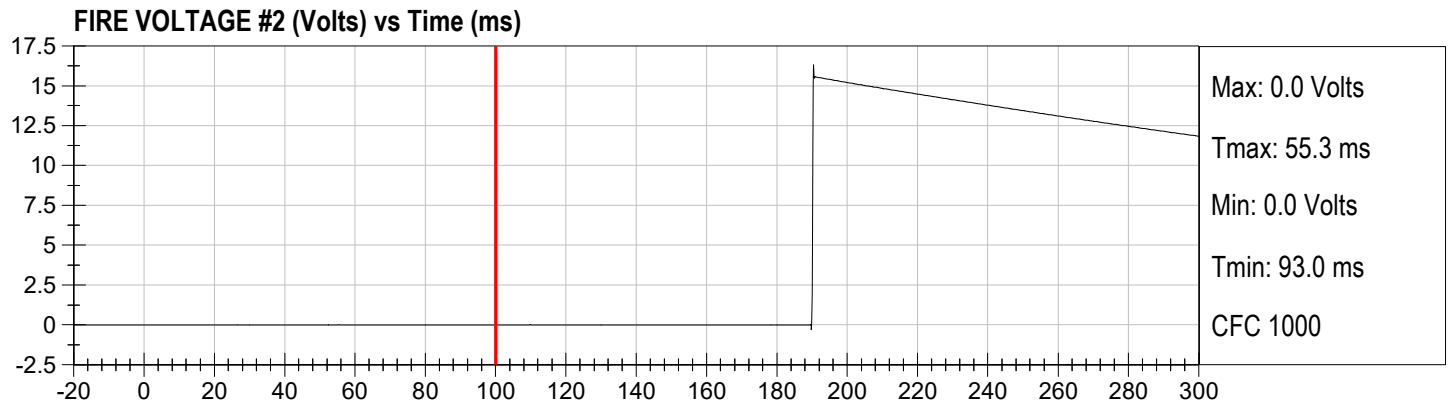
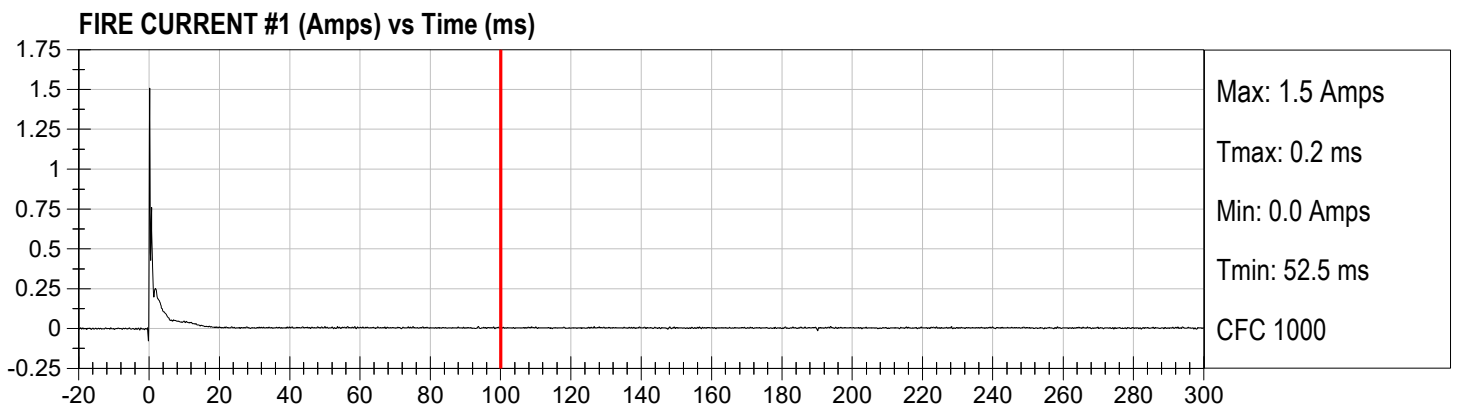
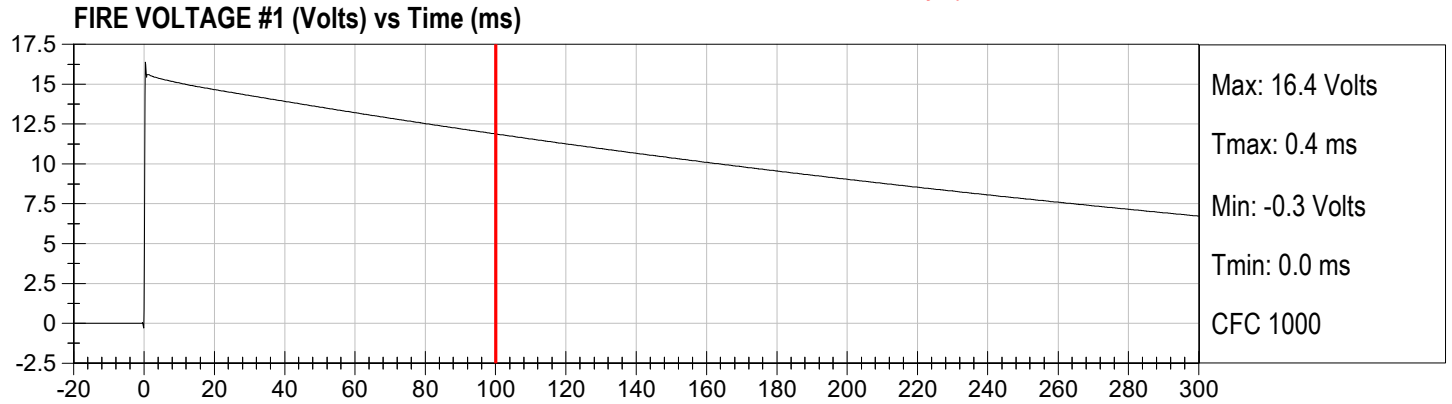

Injury Values Calculated between 0ms and 100ms

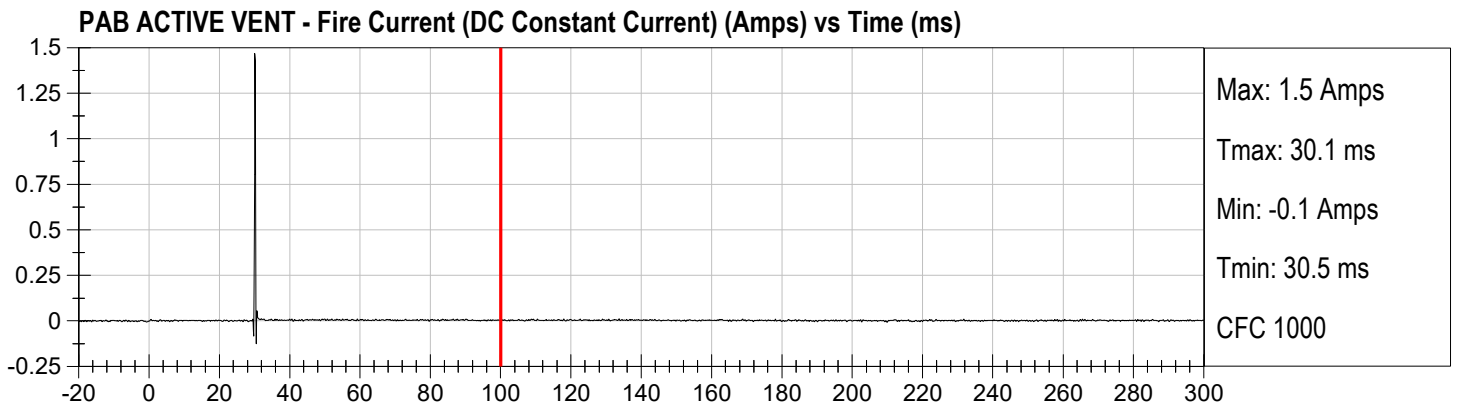
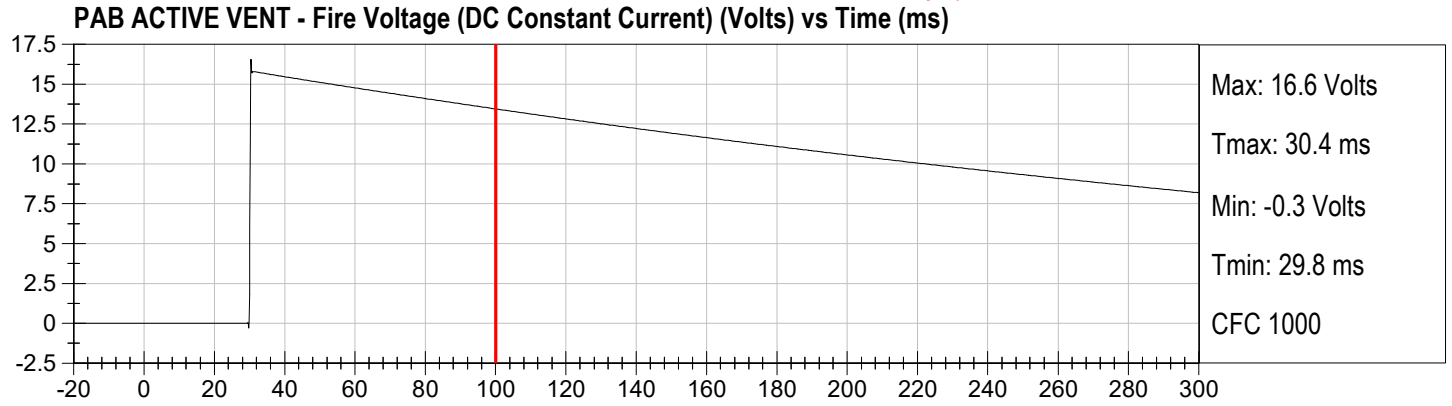

Injury Values Calculated between 0ms and 100ms

PASSENGER Nij (NTF) vs Time (ms)

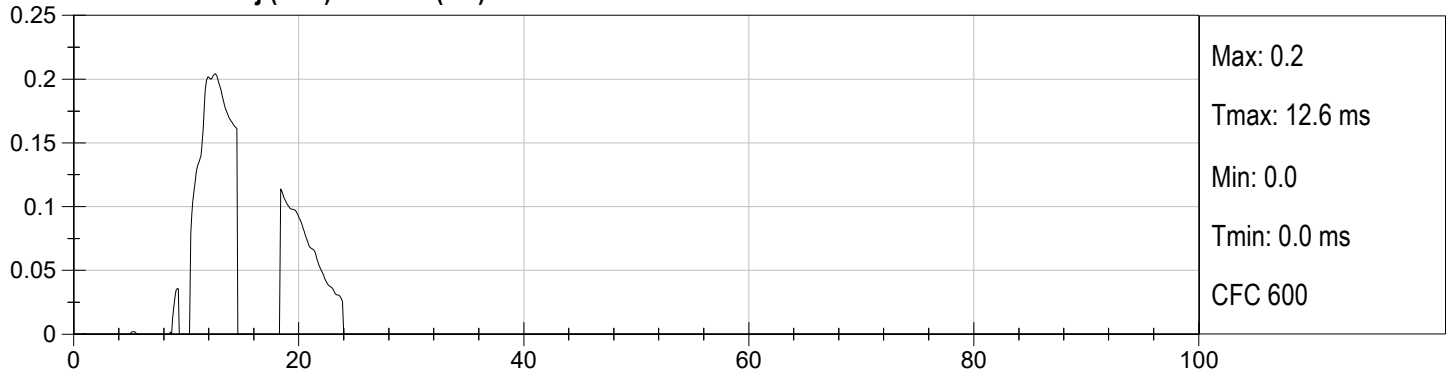

PASSENGER Nij (NTE) vs Time (ms)

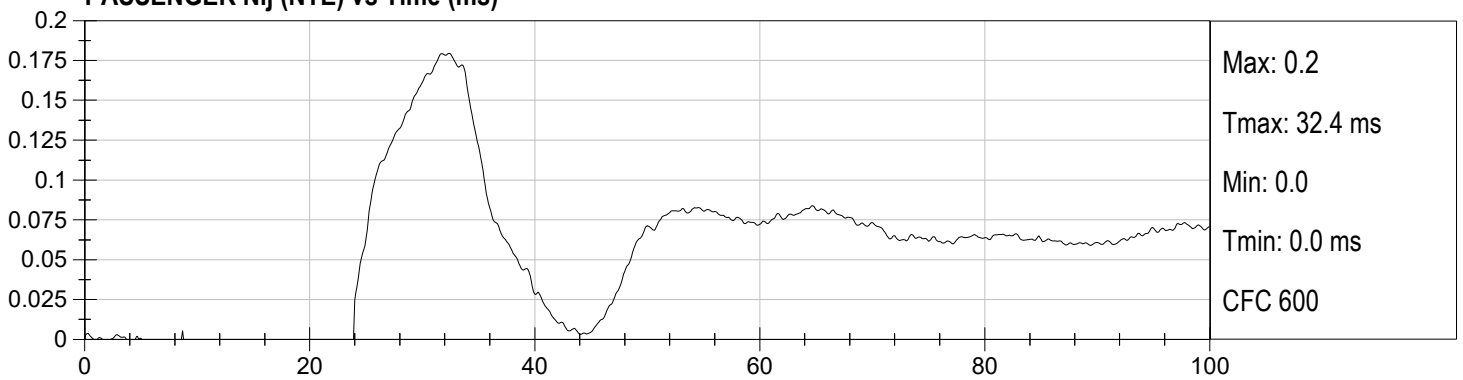

PASSENGER Nij (NCF) vs Time (ms)

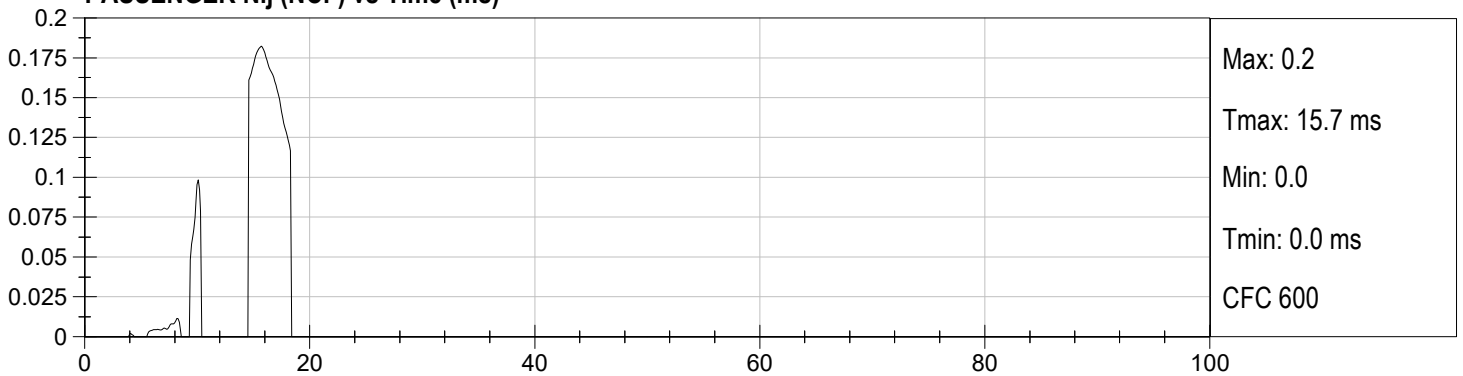

PASSENGER Nij (NCE) vs Time (ms)

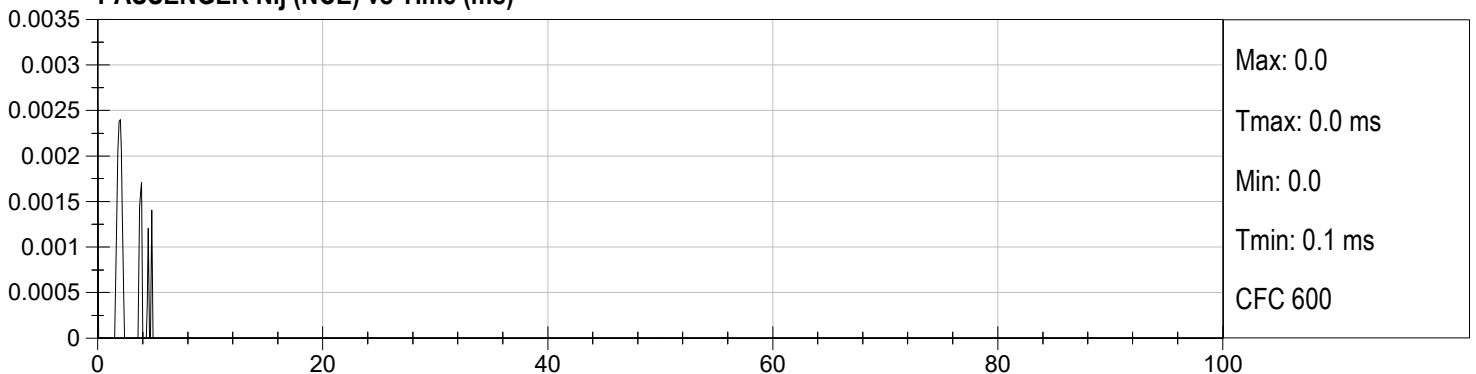

Injury Values Calculated between 0ms and 100ms

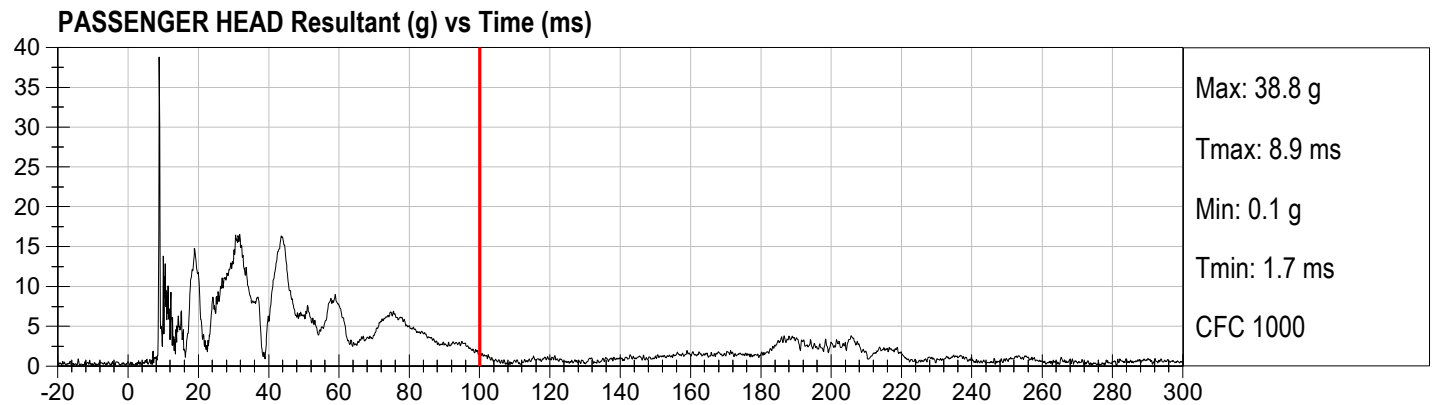
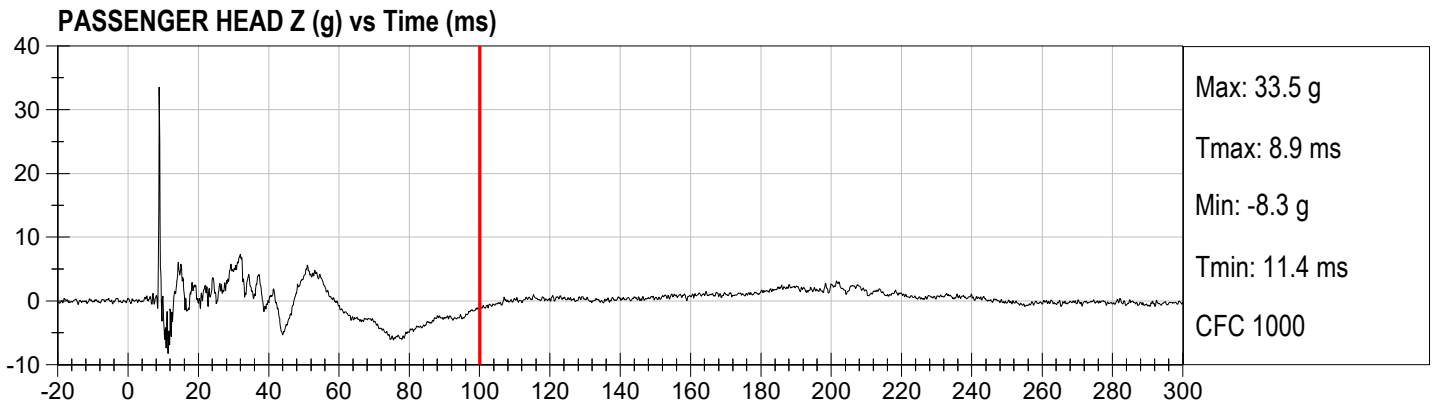
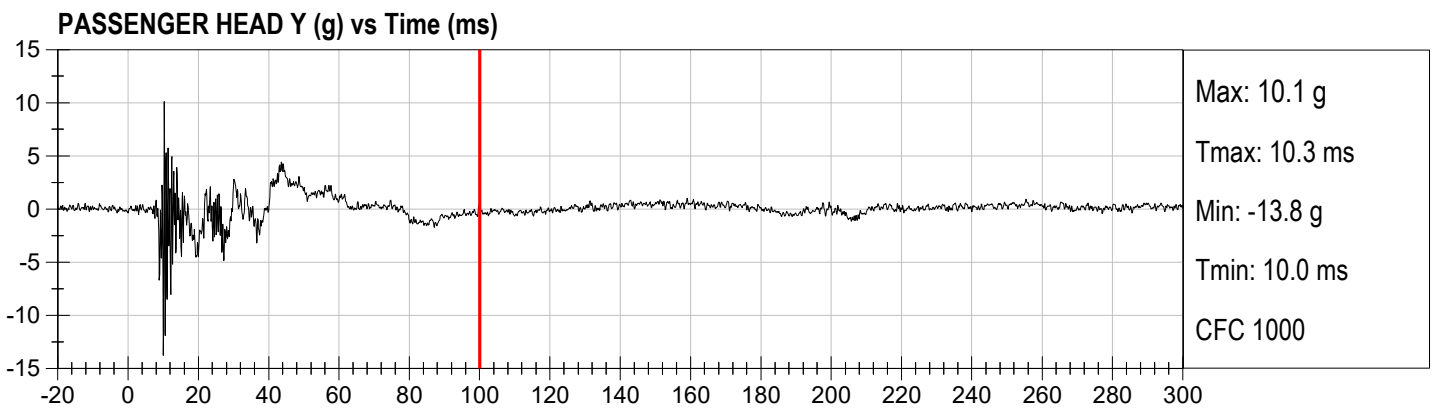
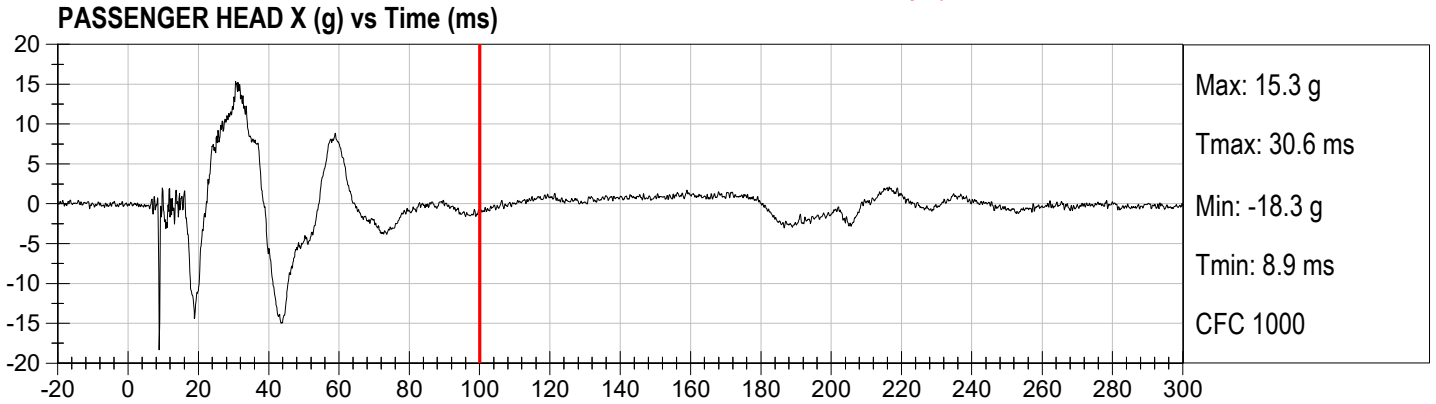

Injury Values Calculated between 0ms and 100ms

PASSENGER HEAD X Velocity (kph) vs Time (ms)

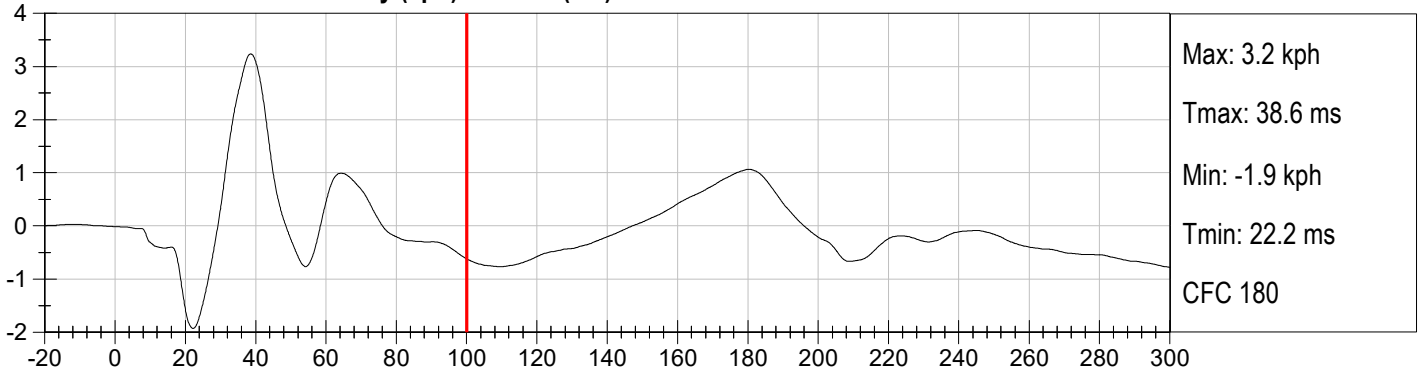

PASSENGER HEAD Y Velocity (kph) vs Time (ms)

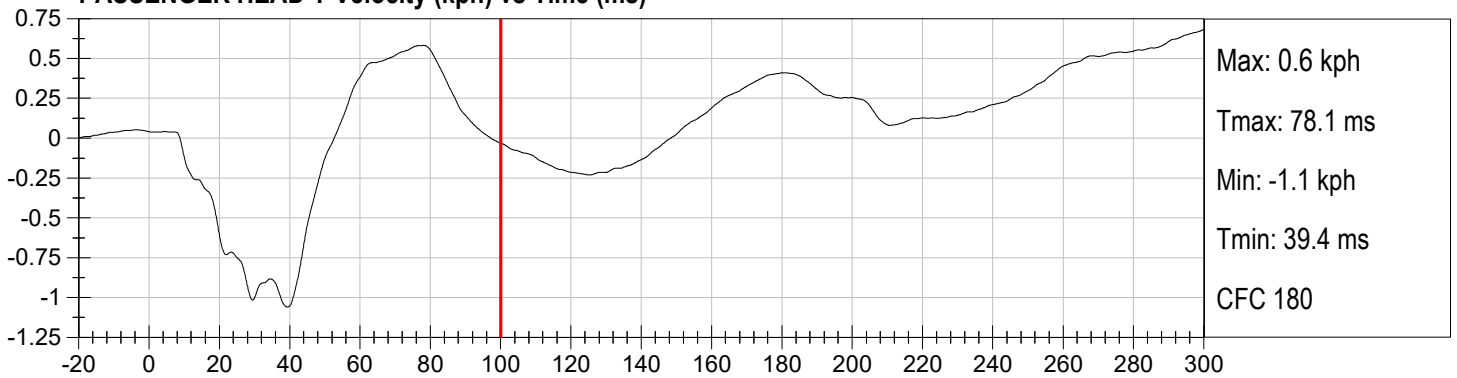

PASSENGER HEAD Z Velocity (kph) vs Time (ms)

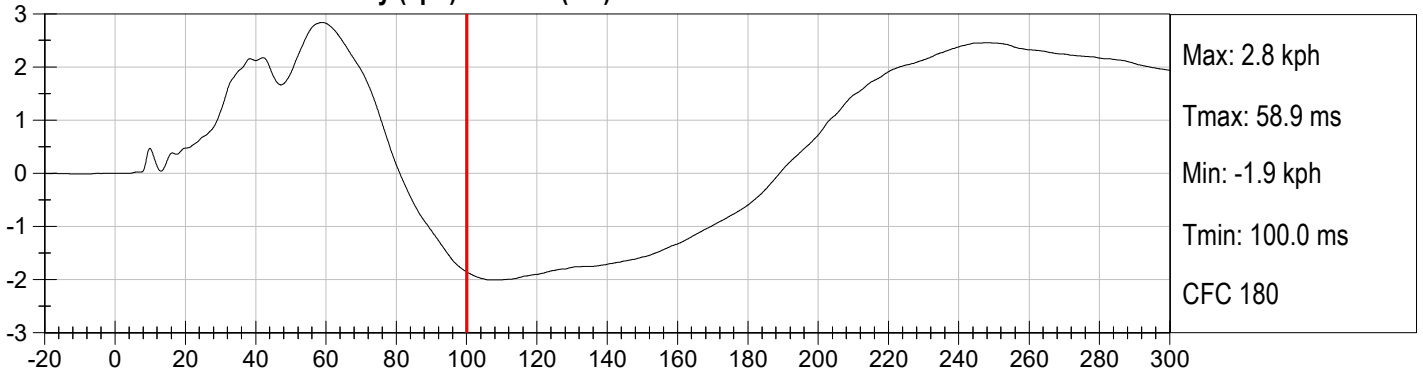

Injury Values Calculated between 0ms and 100ms

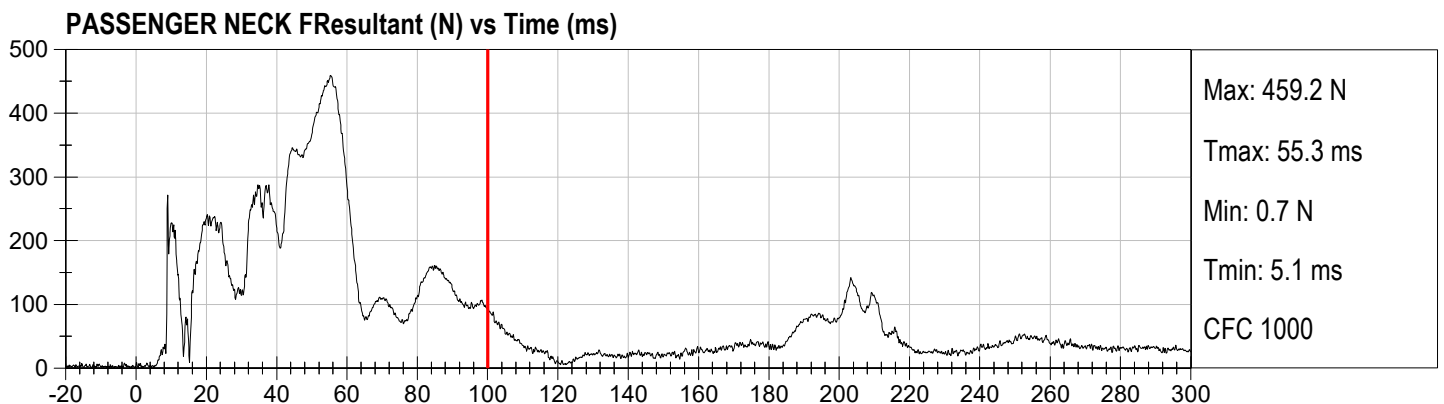
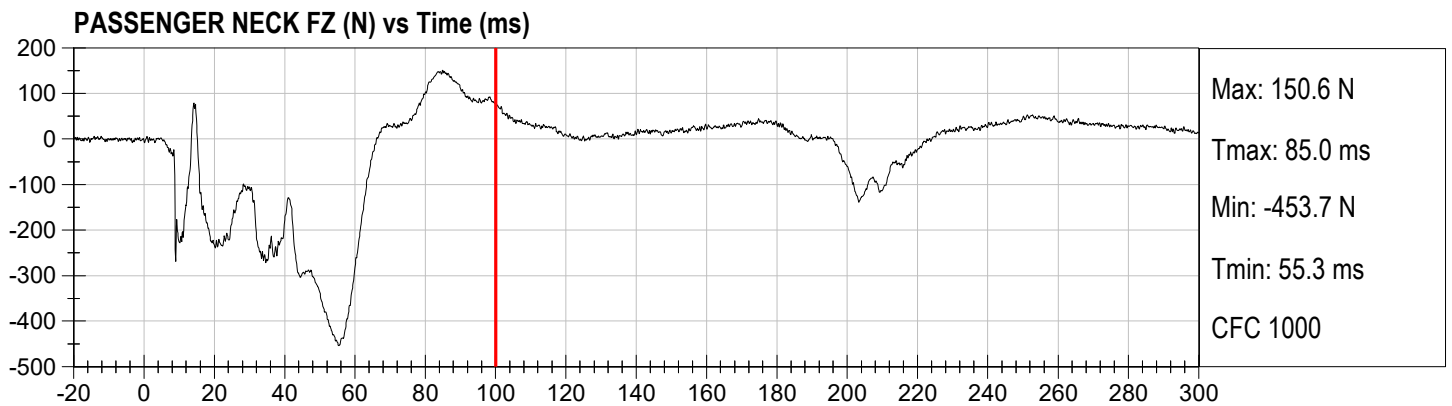
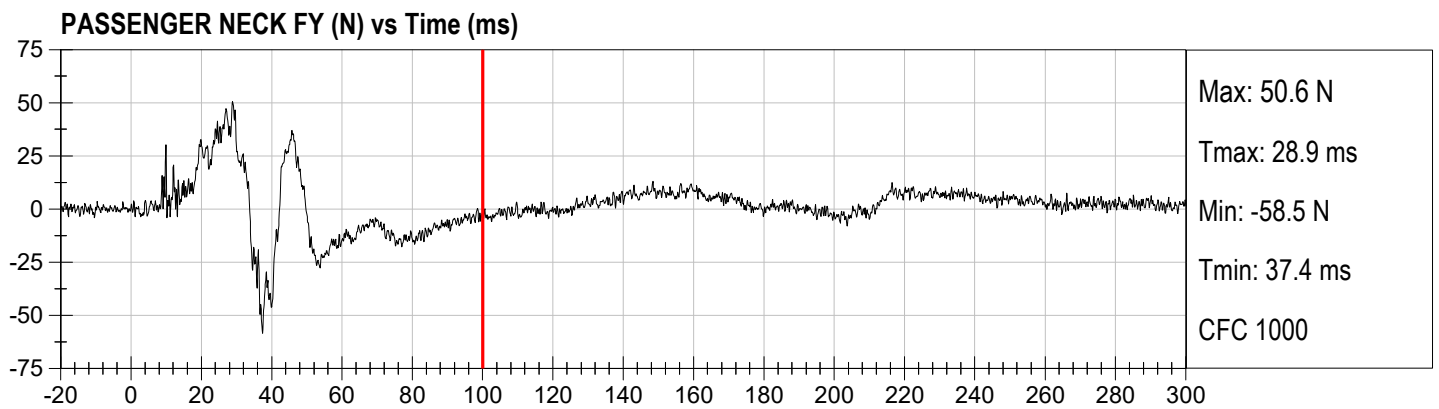
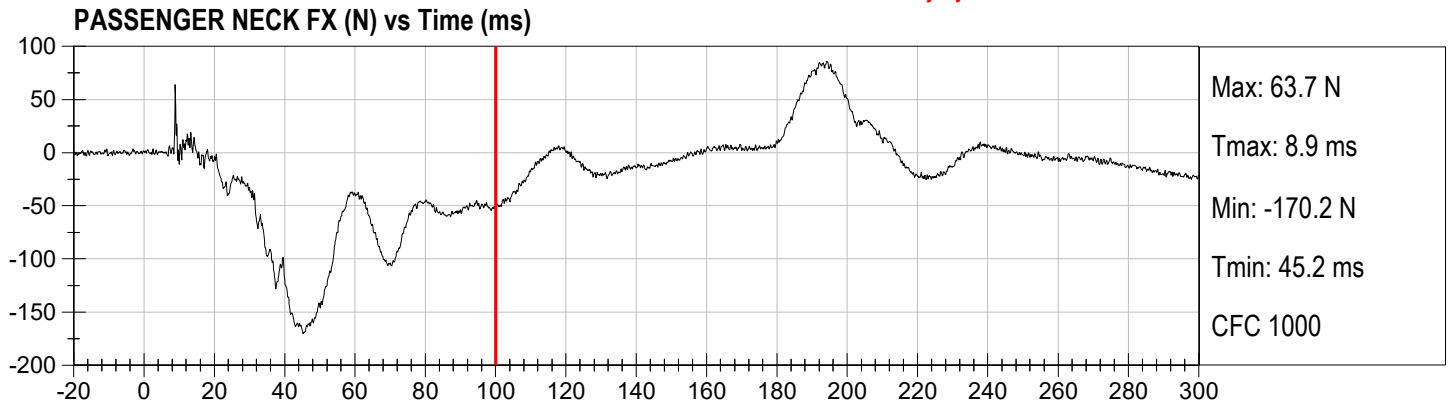

Injury Values Calculated between 0ms and 100ms

PASSENGER NECK MX (Nm) vs Time (ms)

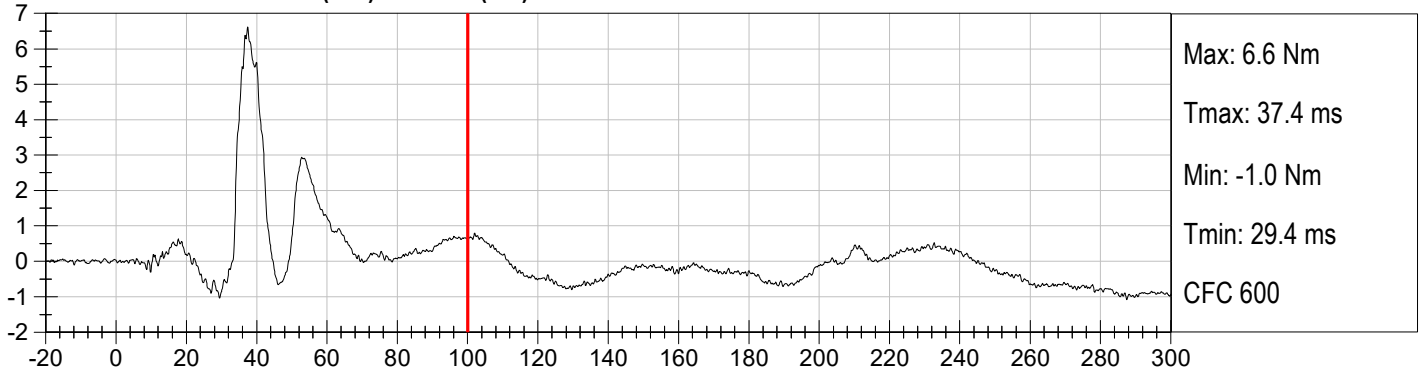

PASSENGER NECK MY (Nm) vs Time (ms)

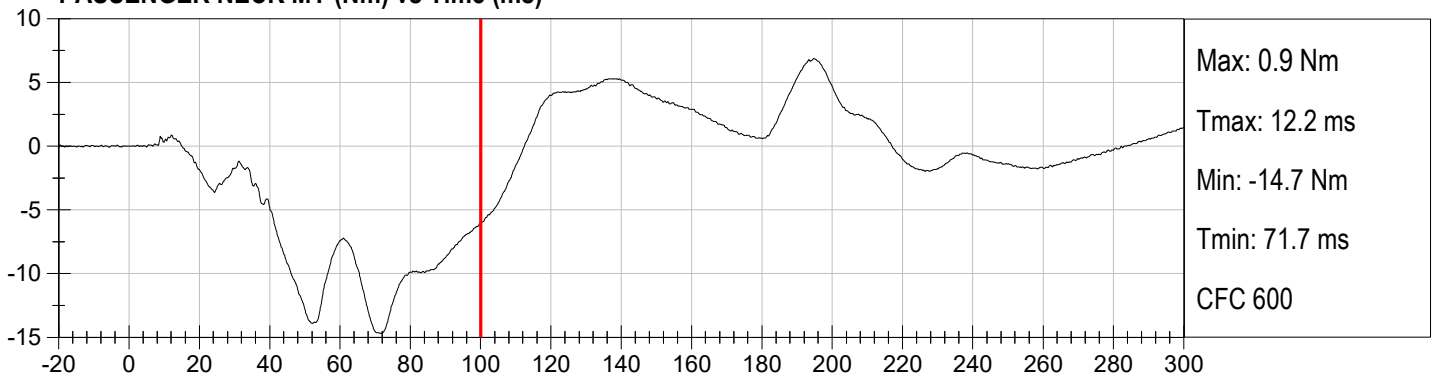

PASSENGER NECK MZ (Nm) vs Time (ms)

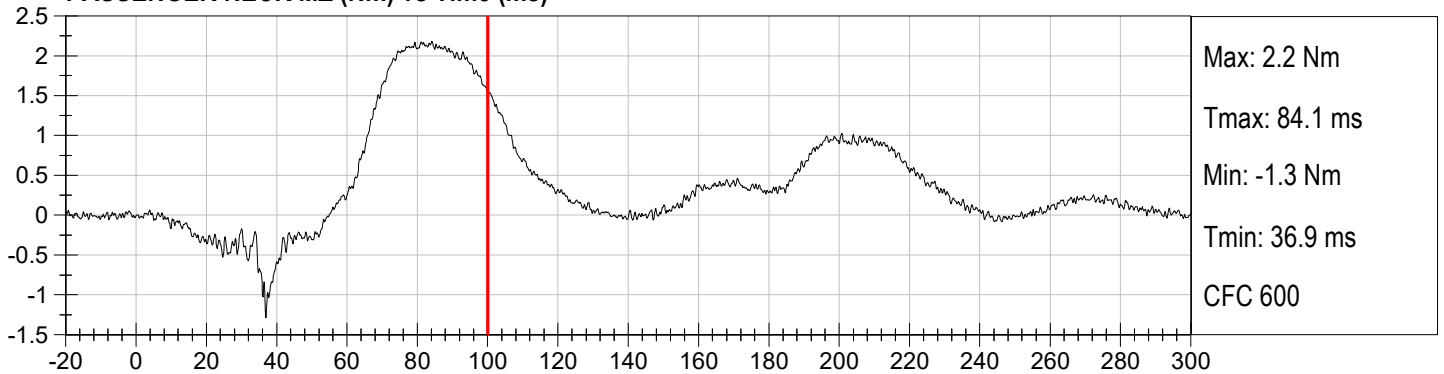

PASSENGER NECK MY Occipital Condyle (Nm) vs Time (ms)

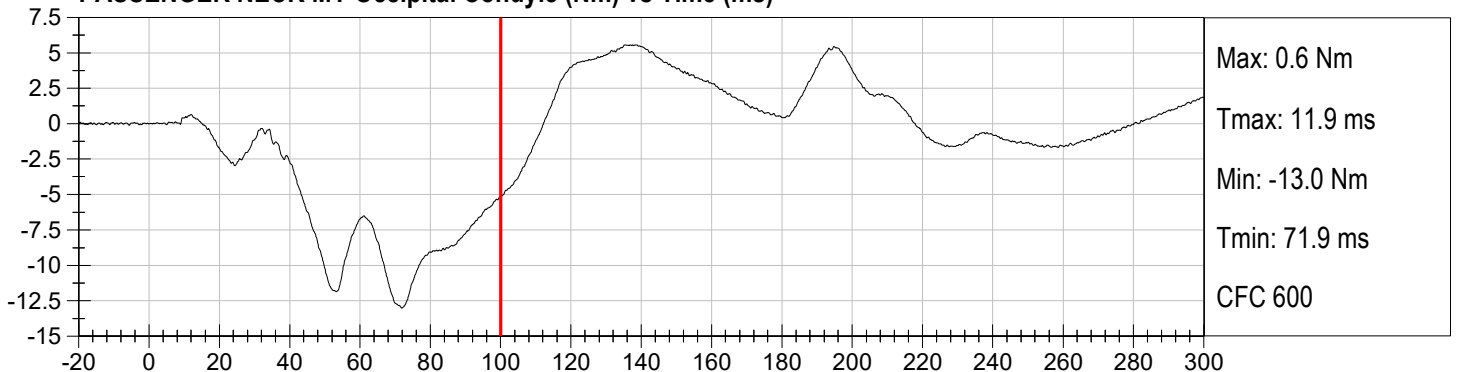

Injury Values Calculated between 0ms and 100ms

PASSENGER CHEST X (g) vs Time (ms)

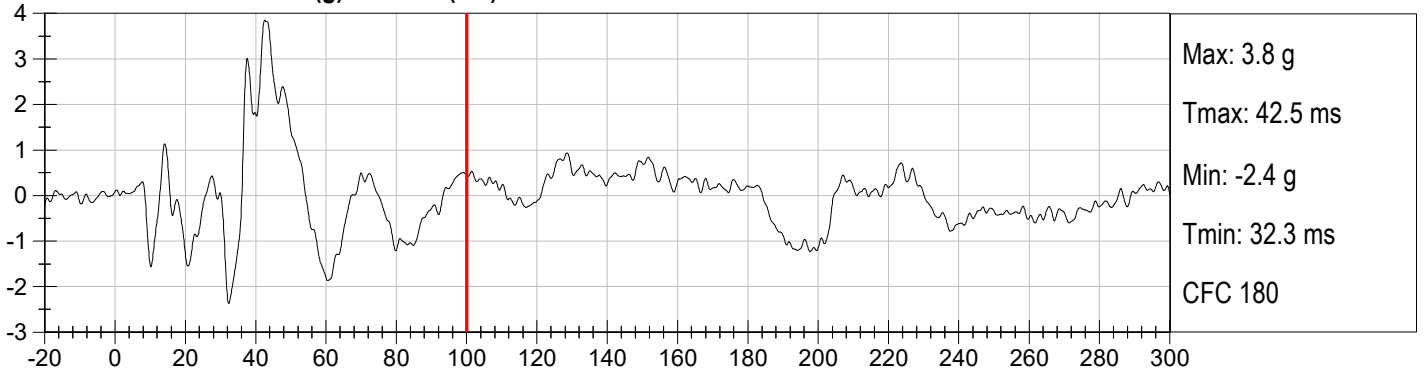

PASSENGER CHEST Y (g) vs Time (ms)

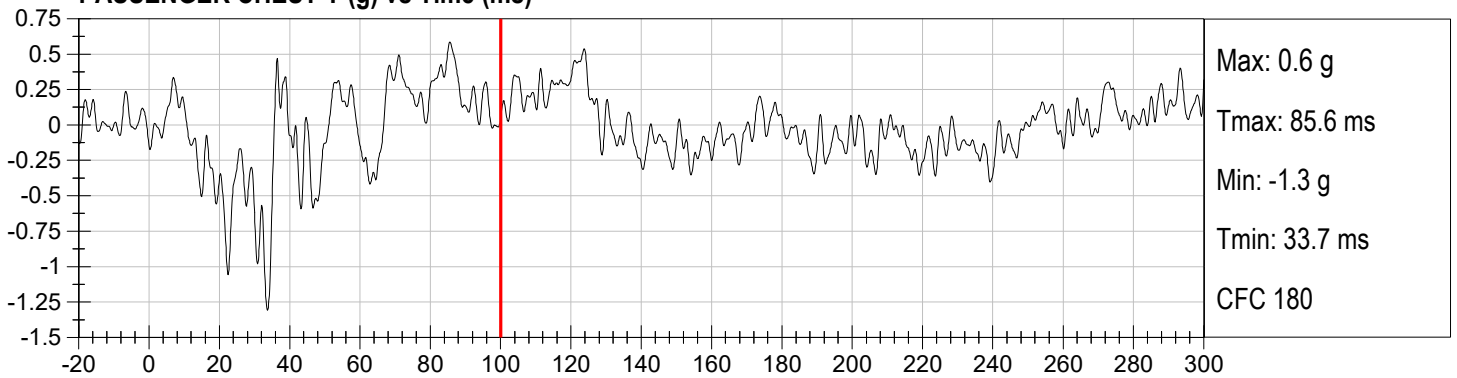

PASSENGER CHEST Z (g) vs Time (ms)

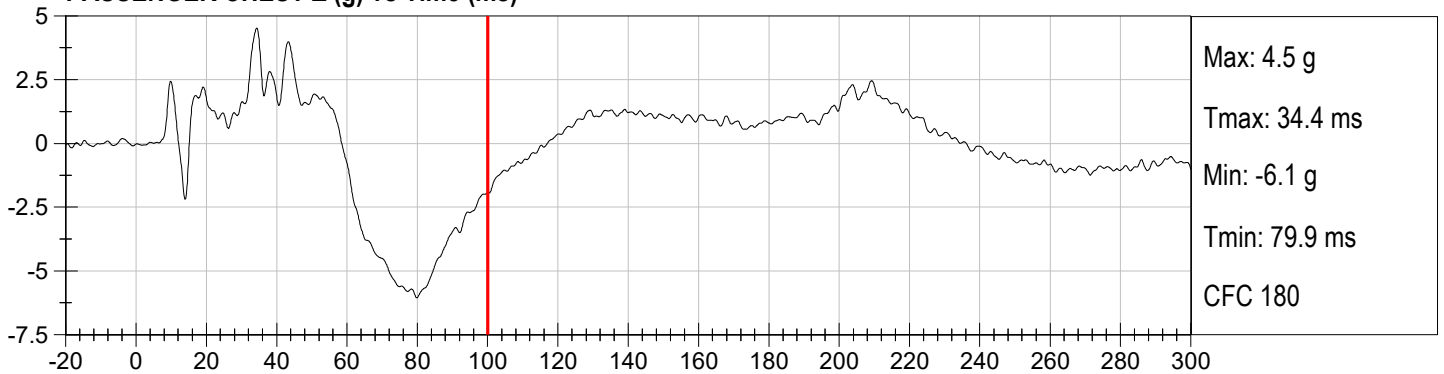

PASSENGER CHEST Resultant (g) vs Time (ms)



Injury Values Calculated between 0ms and 100ms

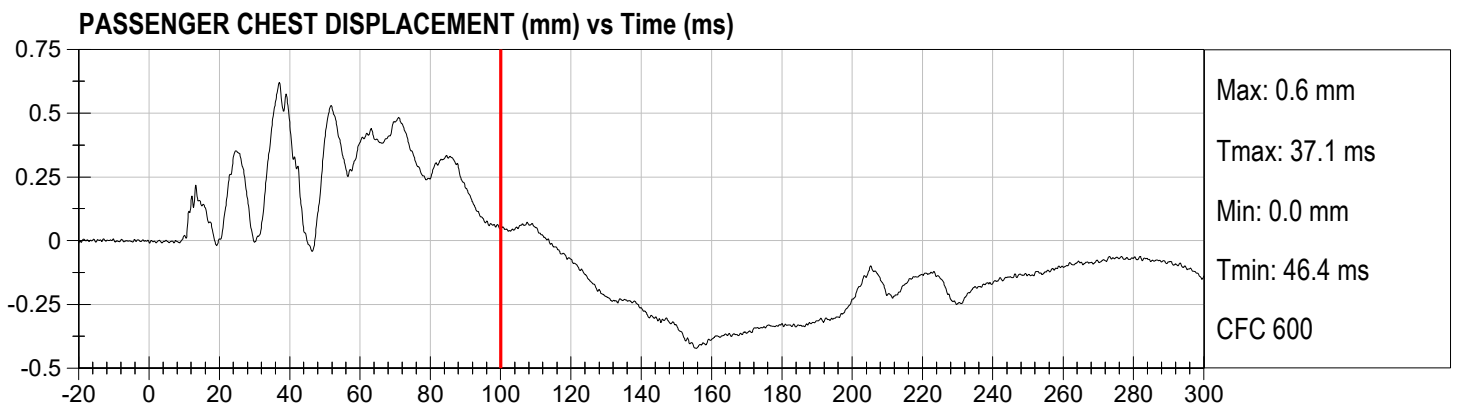
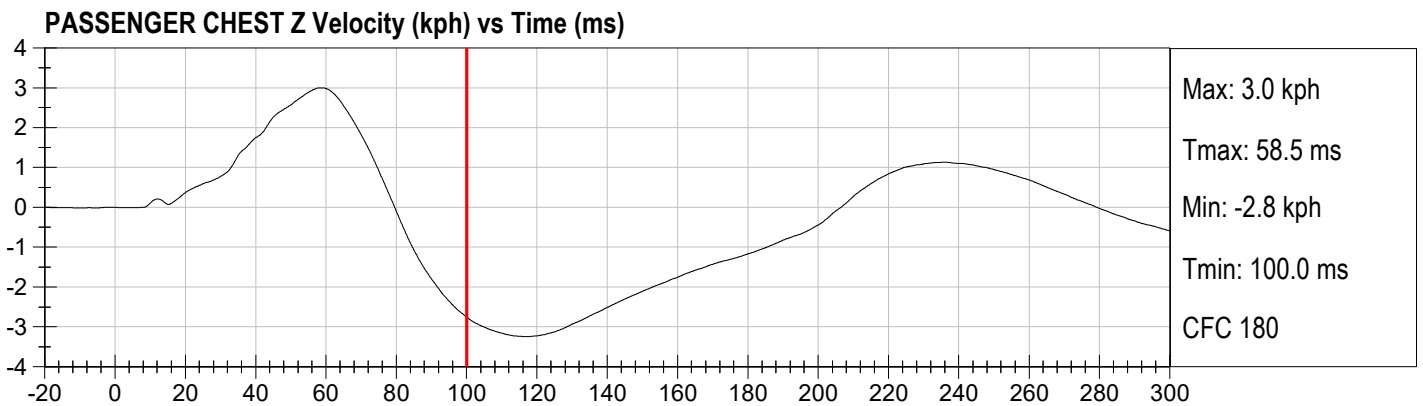
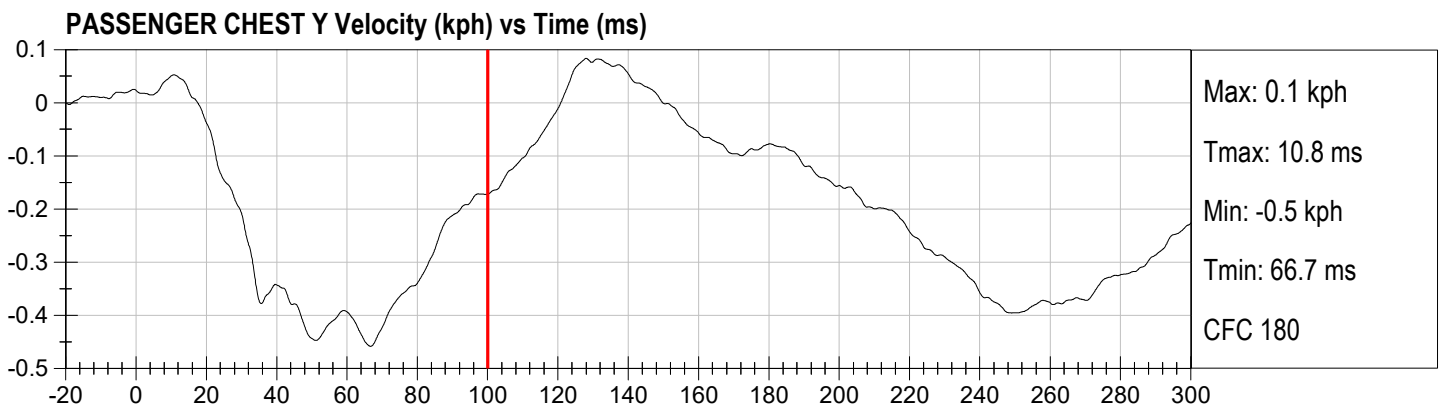
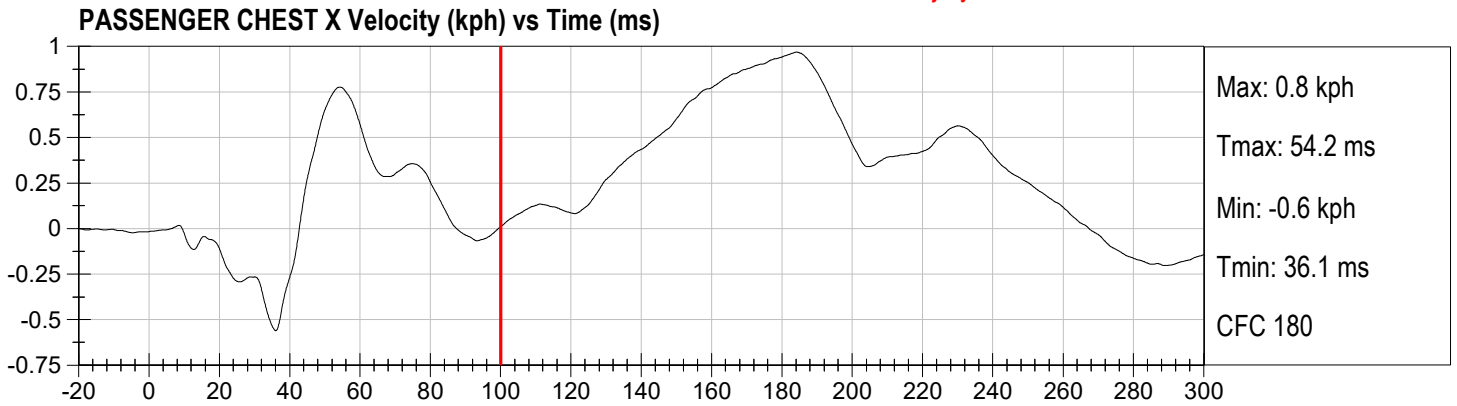

Injury Values Calculated between 0ms and 100ms

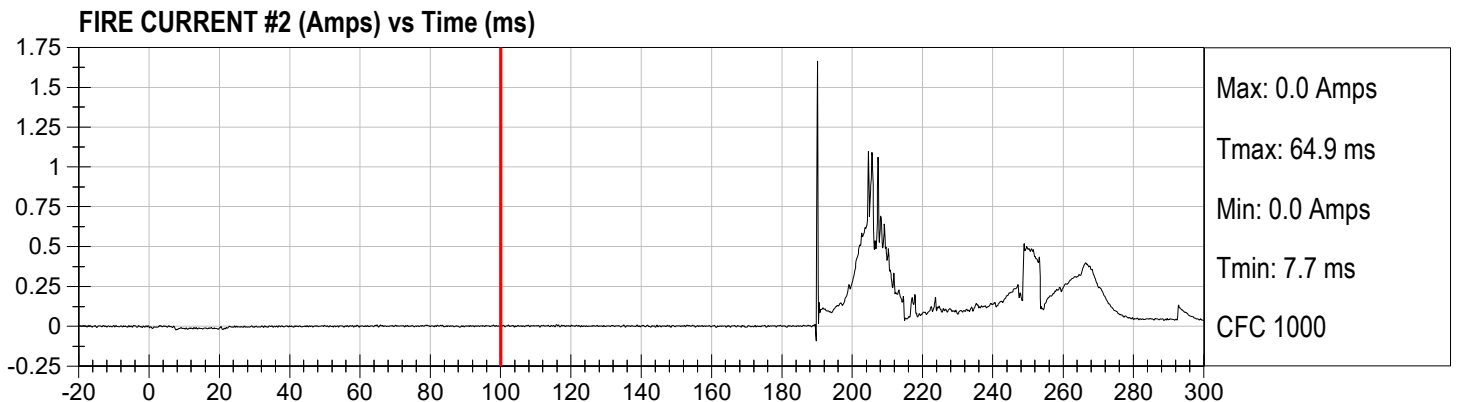
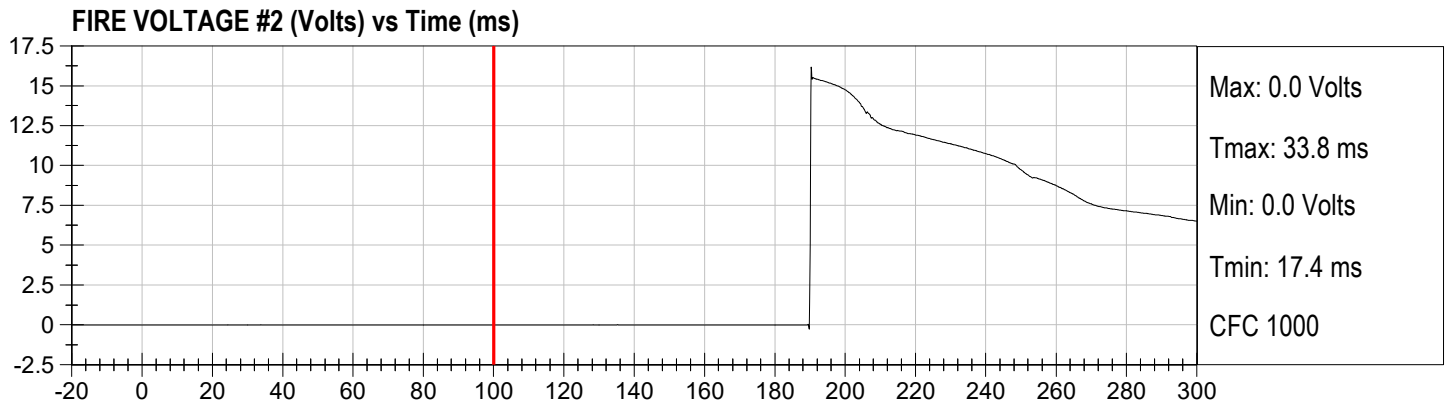
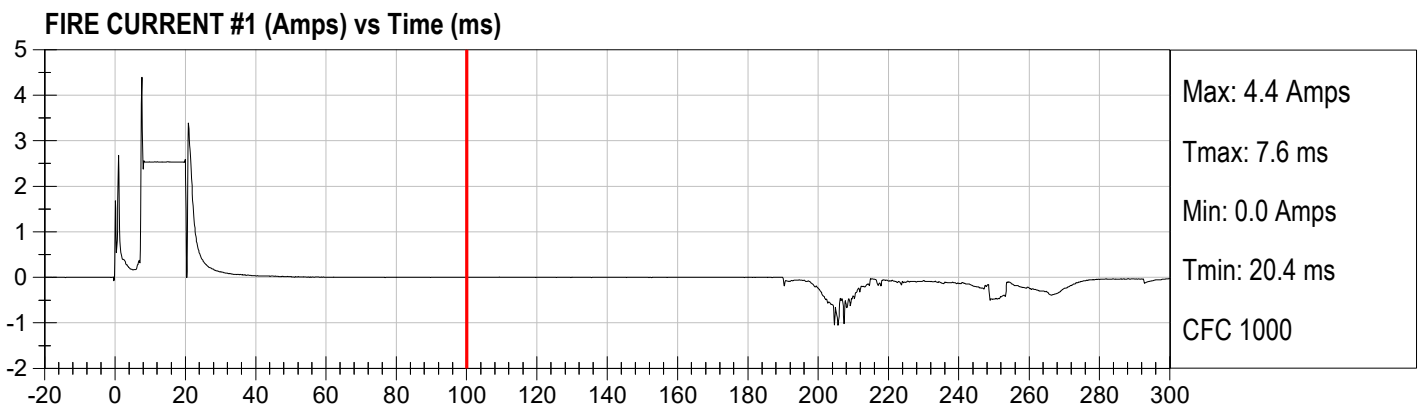
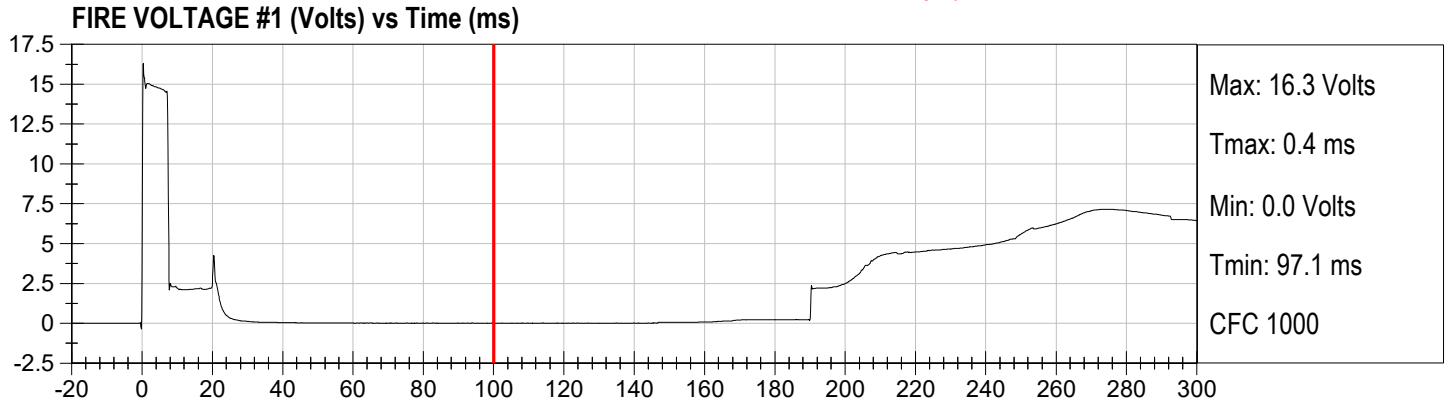

Injury Values Calculated between 0ms and 100ms

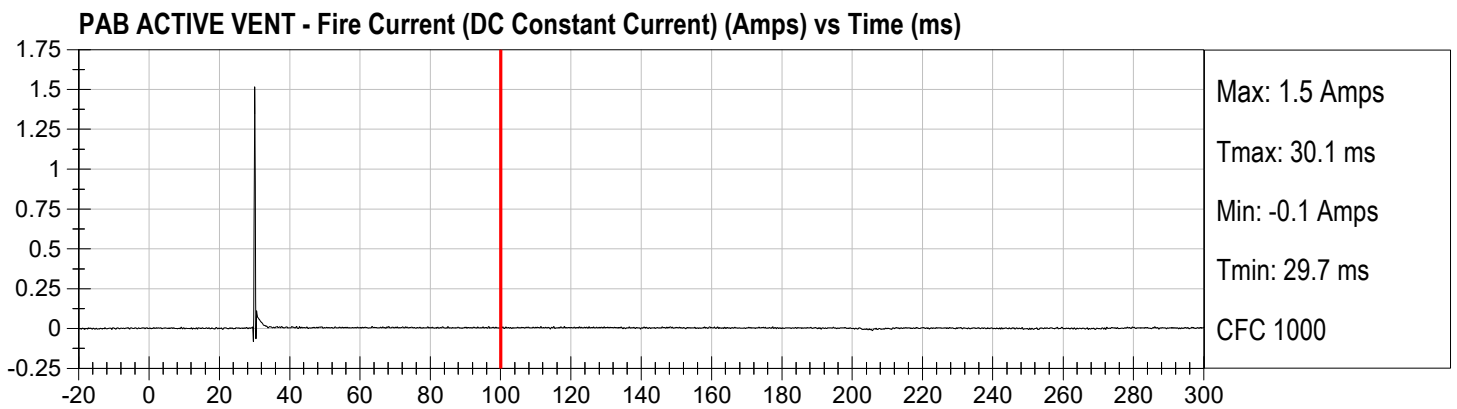
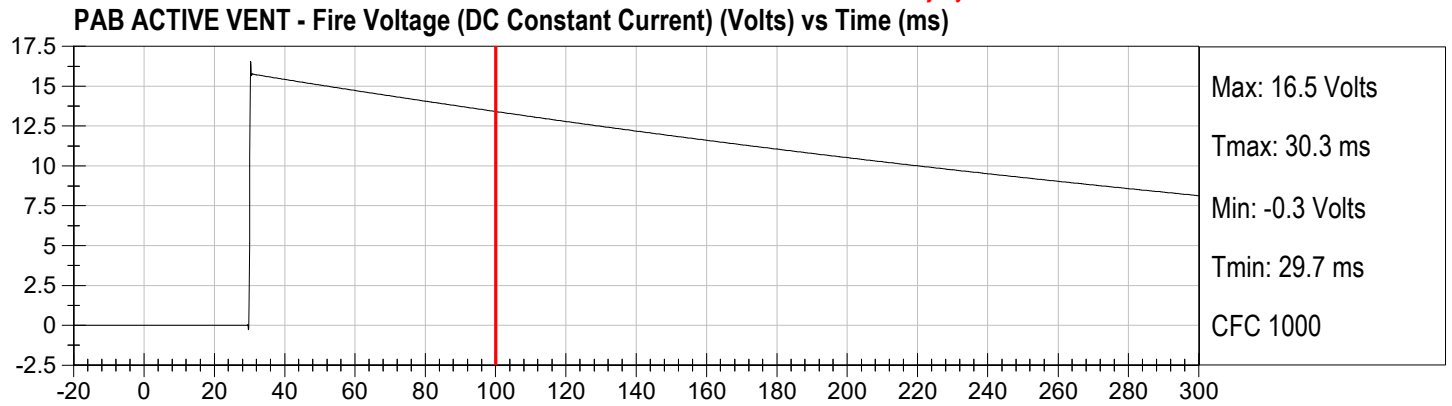

Injury Values Calculated between 0ms and 100ms

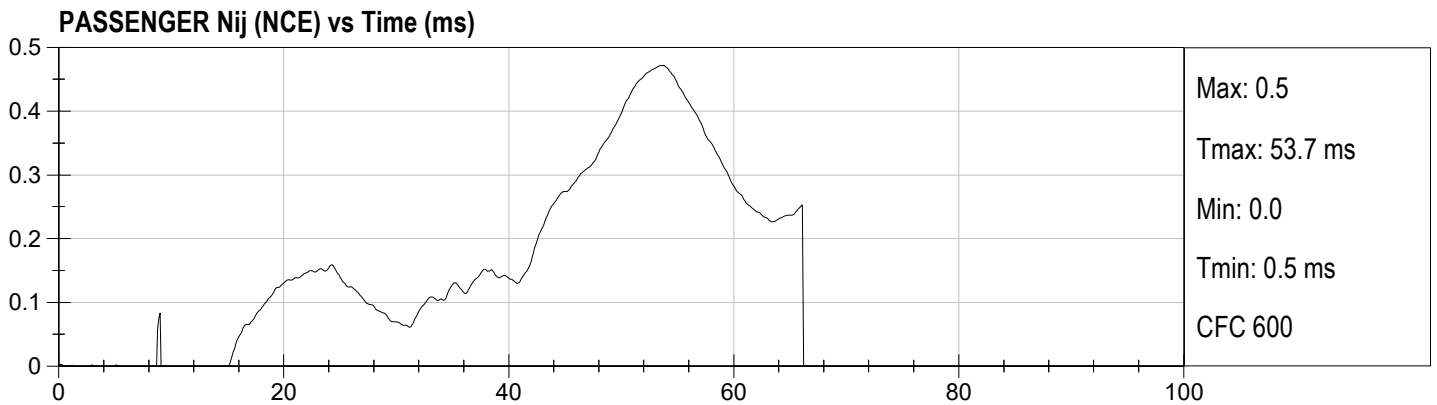
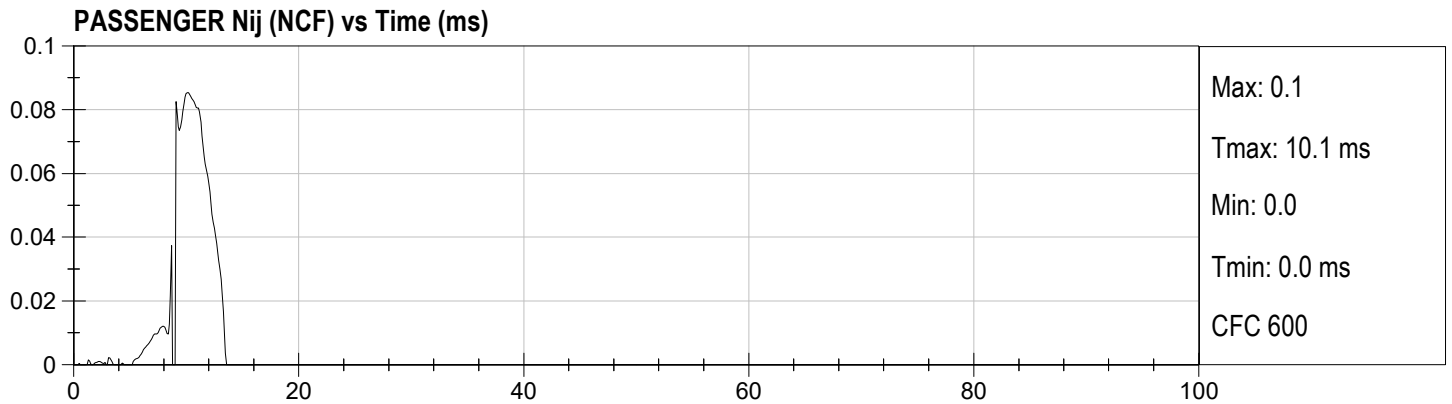
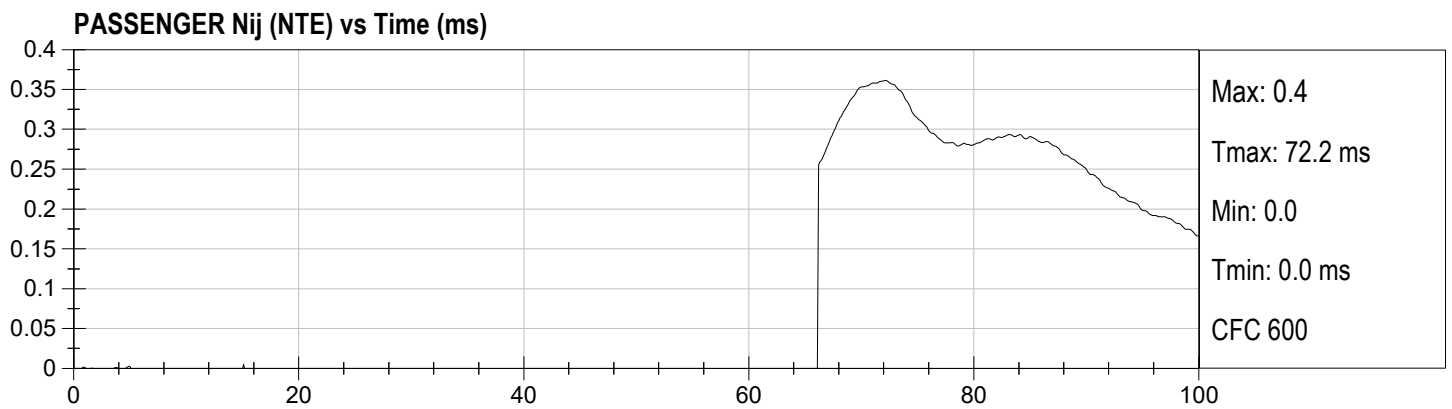
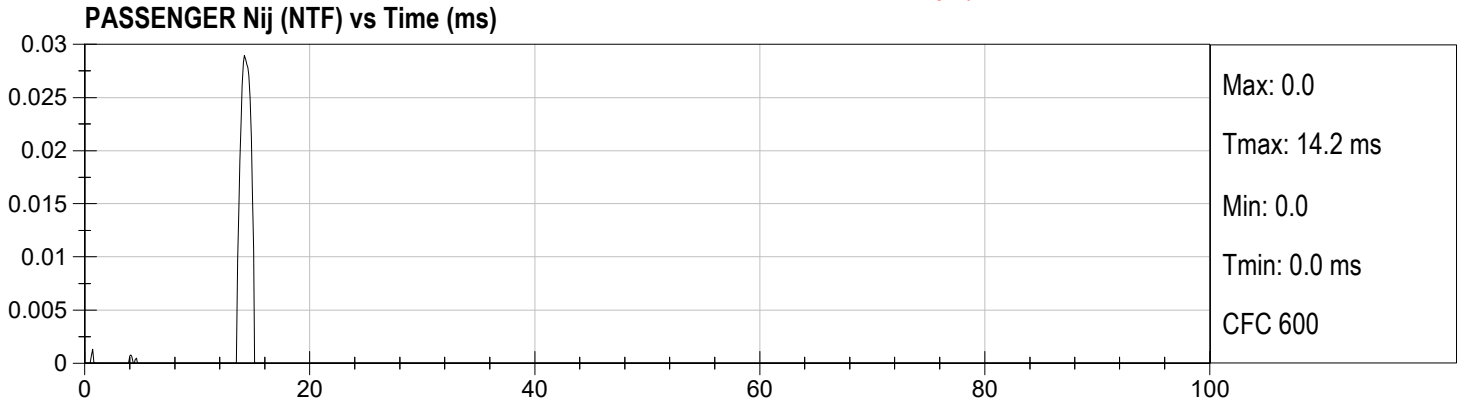

## APPENDIX C

### CRASH TEST PHOTOGRAPHS

#### TABLE OF PHOTOGRAPHS

		<u>Page</u>
		<u>No.</u>
Photo No. 1.	Vehicle Certification Label	C-1
Photo No. 2.	Tire Placard	C-2
Photo No. 3.	Pre-Test Front View of Test Vehicle	C-3
Photo No. 4.	Post-Test Front View of Test Vehicle	C-4
Photo No. 5.	Pre-Test Left Side View of Test Vehicle	C-5
Photo No. 6.	Post-Test Left Side View of Test Vehicle	C-6
Photo No. 7.	Pre-Test Right Side View of Test Vehicle	C-7
Photo No. 8.	Post-Test Right Side View of Test Vehicle	C-8
Photo No. 9.	Pre-Test Left Front Three-Quarter View of Test Vehicle	C-9
Photo No. 10.	Post-Test Left Front Three-Quarter View of Test Vehicle	C-10
Photo No. 11.	Pre-Test Right Front Three-Quarter View of Test Vehicle	C-11
Photo No. 12.	Post-Test Right Front Three-Quarter View of Test Vehicle	C-12
Photo No. 13.	Pre-Test Right Rear Three-Quarter View of Test Vehicle	C-13
Photo No. 14.	Post-Test Right Rear Three-Quarter View of Test Vehicle	C-14
Photo No. 15.	Pre-Test Left Rear Three-Quarter View of Test Vehicle	C-15
Photo No. 16.	Post-Test Left Rear Three-Quarter View of Test Vehicle	C-16
Photo No. 17.	Pre-Test Rear View of Test Vehicle	C-17
Photo No. 18.	Post-Test Rear View of Test Vehicle	C-18
Photo No. 19.	Pre-Test Windshield View	C-19
Photo No. 20.	Post-Test Windshield View	C-20
Photo No. 21.	Pre-Test Engine Compartment View	C-21
Photo No. 22.	Post-Test Engine Compartment View	C-22
Photo No. 23.	Pre-Test Fuel Filler Cap View	C-23
Photo No. 24.	Post-Test Fuel Filler Cap View	C-24
Photo No. 25.	Pre-Test Front Underbody View	C-25
Photo No. 26.	Post-Test Front Underbody View	C-26
Photo No. 27.	Pre-Test Mid Rear Underbody View	C-27
Photo No. 28.	Post-Test Mid Rear Underbody View	C-28
Photo No. 29.	Pre-Test Rear Underbody View	C-29
Photo No. 30.	Post-Test Rear Underbody View	C-30
Photo No. 31.	Pre-Test Driver Dummy Front View (head position)	C-31
Photo No. 32.	Post-Test Driver Dummy Front View (head position)	C-32
Photo No. 33.	Pre-Test Driver Dummy Position Left Side View	C-33

		<u>Page No.</u>
Photo No. 34.	Post-Test Driver Dummy Position Left Side View	C-34
Photo No. 35.	Pre-Test Driver Dummy Position Left Side View (door open)	C-35
Photo No. 36.	Post-Test Driver Dummy Position Left Side View (door open)	C-36
Photo No. 37.	Pre-Test Driver Dummy Seat Position	C-37
Photo No. 38.	Post-Test Driver Dummy Seat Position	C-38
Photo No. 39.	Pre-Test Driver Dummy Feet Position	C-39
Photo No. 40.	Post-Test Driver Dummy Feet Position	C-40
Photo No. 41.	Pre-Test Driver Side Knee Bolster View	C-41
Photo No. 42.	Post-Test Driver Side Knee Bolster View	C-42
Photo No. 43.	Post-Test Driver Dummy Airbag Contact	C-43
Photo No. 44.	Post-Test Driver Dummy Knee Contact	C-44
Photo No. 45.	Post-Test Driver Dummy Head Contact (headrest)	C-45
Photo No. 46.	Pre-Test Passenger Dummy Front View (head position)	C-46
Photo No. 47.	Post-Test Passenger Dummy Front View (head position)	C-47
Photo No. 48.	Pre-Test Passenger Dummy Position Right Side View	C-48
Photo No. 49.	Post-Test Passenger Dummy Position Right Side View	C-49
Photo No. 50.	Pre-Test Passenger Dummy Position Right Side View (door open)	C-50
Photo No. 51.	Post-Test Passenger Dummy Position Right Side View (door open)	C-51
Photo No. 52.	Pre-Test Passenger Dummy Seat Position	C-52
Photo No. 53.	Post-Test Passenger Dummy Seat Position	C-53
Photo No. 54.	Pre-Test Passenger Dummy Feet Position	C-54
Photo No. 55.	Post-Test Passenger Dummy Feet Position	C-55
Photo No. 56.	Pre-Test Passenger Side Knee Bolster View	C-56
Photo No. 57.	Post-Test Passenger Side Knee Bolster View	C-57
Photo No. 58.	Post-Test Passenger Dummy Airbag Contact	C-58
Photo No. 59.	Post-Test Passenger Dummy Knee Contact	C-59
Photo No. 60.	Post-Test Passenger Head Contact (Headrest)	C-60
Photo No. 61.	90 Degree Rollover	C-61
Photo No. 62.	180 Degree Rollover	C-62
Photo No. 63.	270 Degree Rollover	C-63
Photo No. 64.	360 Degree Rollover	C-64
Photo No. 65.	Temperature Plot	C-65

**MFD BY VOLVO CAR CORPORATION**      **MADE IN BELGIUM**      **DATE: 06/22**  
**VIN: YV4K92HK4P2917194**      **MARKET CODE: 31**      **GVWR: 4915 LB**  
**TIRES: 235/55R18**      **COLOUR: 735**      **GAWR FRONT: 2620 LB**  
**RIM: 7.5Jx18x50.5**      **TYPE: MPV**      **GAWR REAR: 2400 LB**

**VOLVO**

THIS VEHICLE CONFORMS TO ALL APPLICABLE FEDERAL MOTOR  
 VEHICLE SAFETY, BUMPER AND THEFT PREVENTION STANDARDS IN EFFECT  
 ON THE DATE OF MANUFACTURE SHOWN ABOVE.



32366354

Photo No. 1 - Vehicle Certification Label

**TIRE AND LOADING INFORMATION**

SEATING CAPACITY | TOTAL 5 | FRONT 2 | REAR 3

The combined weight of occupants : 420kg or 925lbs.  
and cargo should never exceed

**SEE OWNERS MANUAL FOR ADDITIONAL INFORMATION**

TIRE	SIZE	COLD TIRE PRESSURE
FRONT	235/55R18	230kPa, 33psi
REAR	235/55R18	230kPa, 33psi
SPARE	T125/70R18	420kPa, 60psi

**VOLVO** 31416488

0612

Photo No. 2 - Tire Placard



Photo No. 3 - Pre-Test Front View of Test Vehicle



Photo No. 4 - Post-Test Front View of Test Vehicle



Photo No. 5 - Pre-Test Left Side View of Test Vehicle



Photo No. 6 - Post-Test Left Side View of Test Vehicle



Photo No. 7 - Pre-Test Right Side View of Test Vehicle

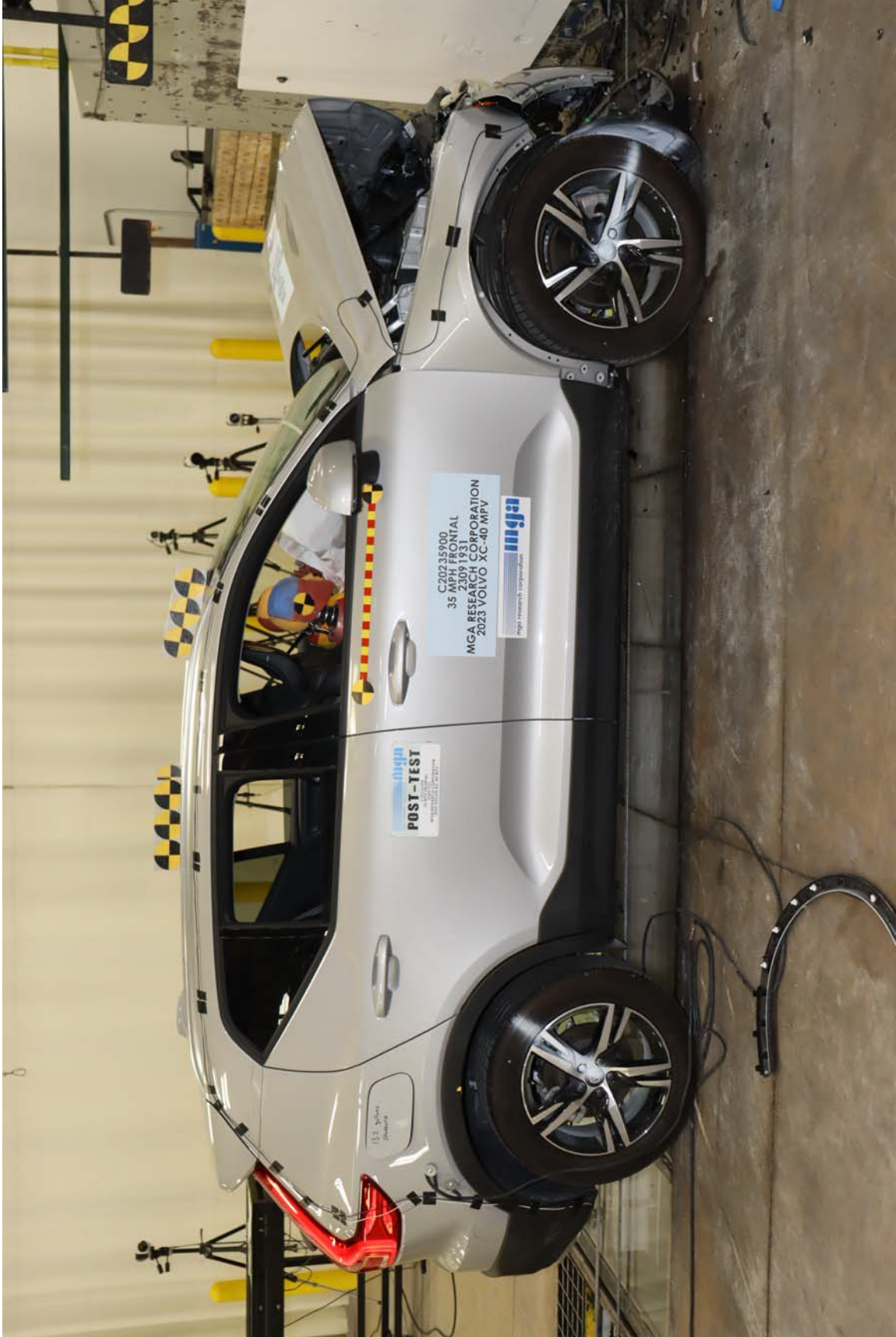

Photo No. 8 - Post-Test Right Side View of Test Vehicle

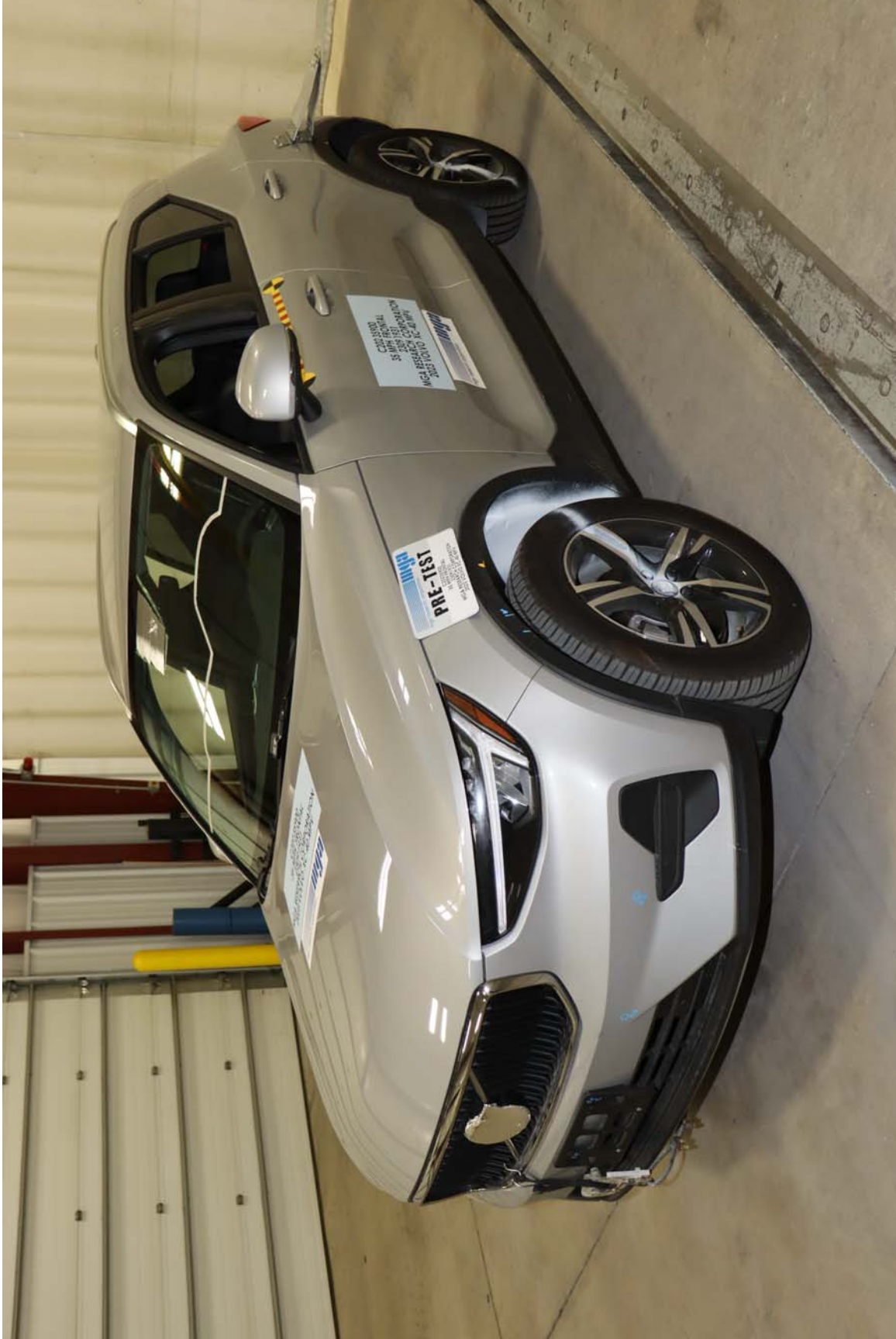

Photo No. 9 - Pre-Test Left Front Three-Quarter View of Test Vehicle

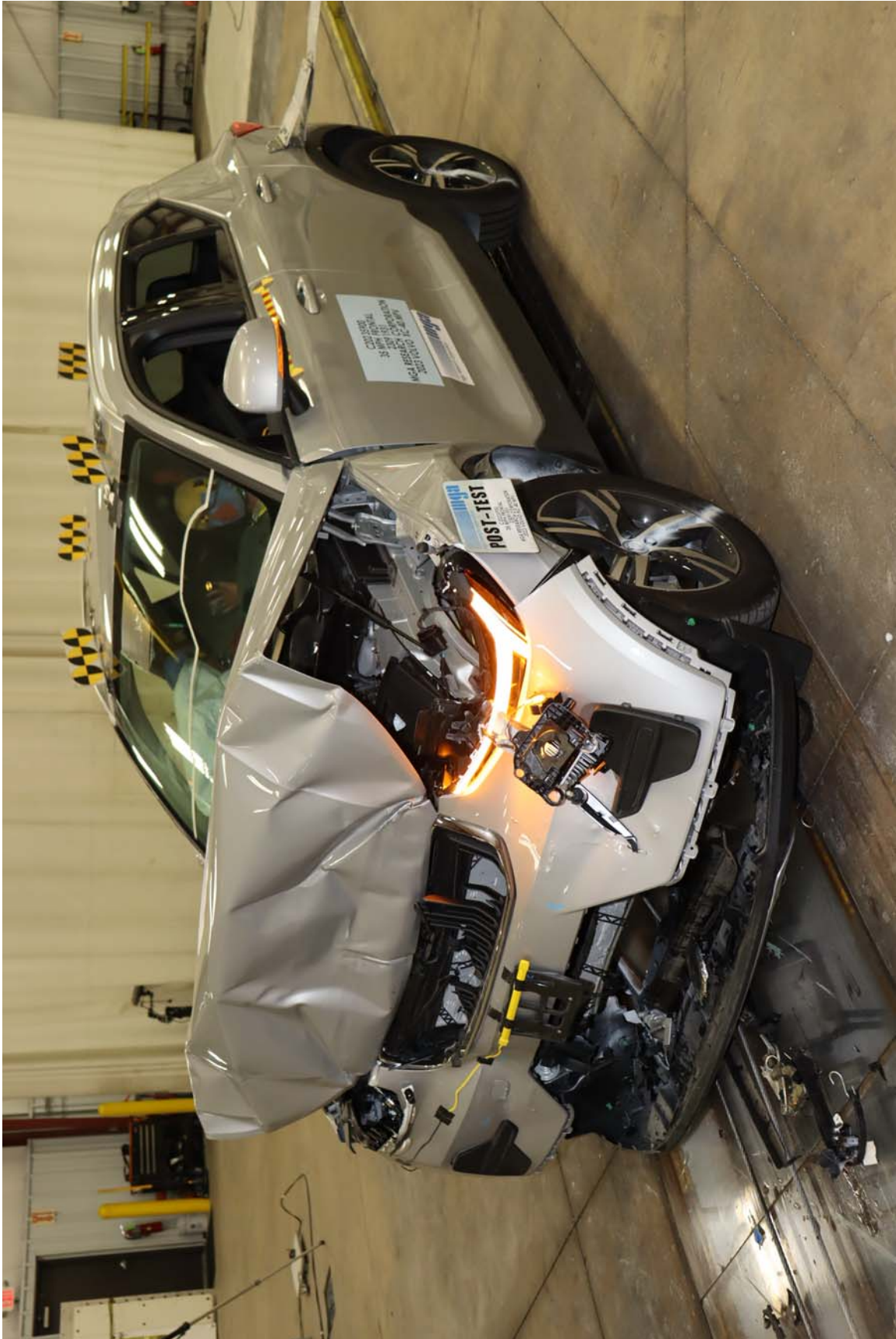

Photo No. 10 - Post-Test Left Front Three-Quarter View of Test Vehicle





Photo No. 12 - Post-Test Right Front Three-Quarter View of Test Vehicle



Photo No. 13 - Pre-Test Right Rear Three-Quarter View of Test Vehicle

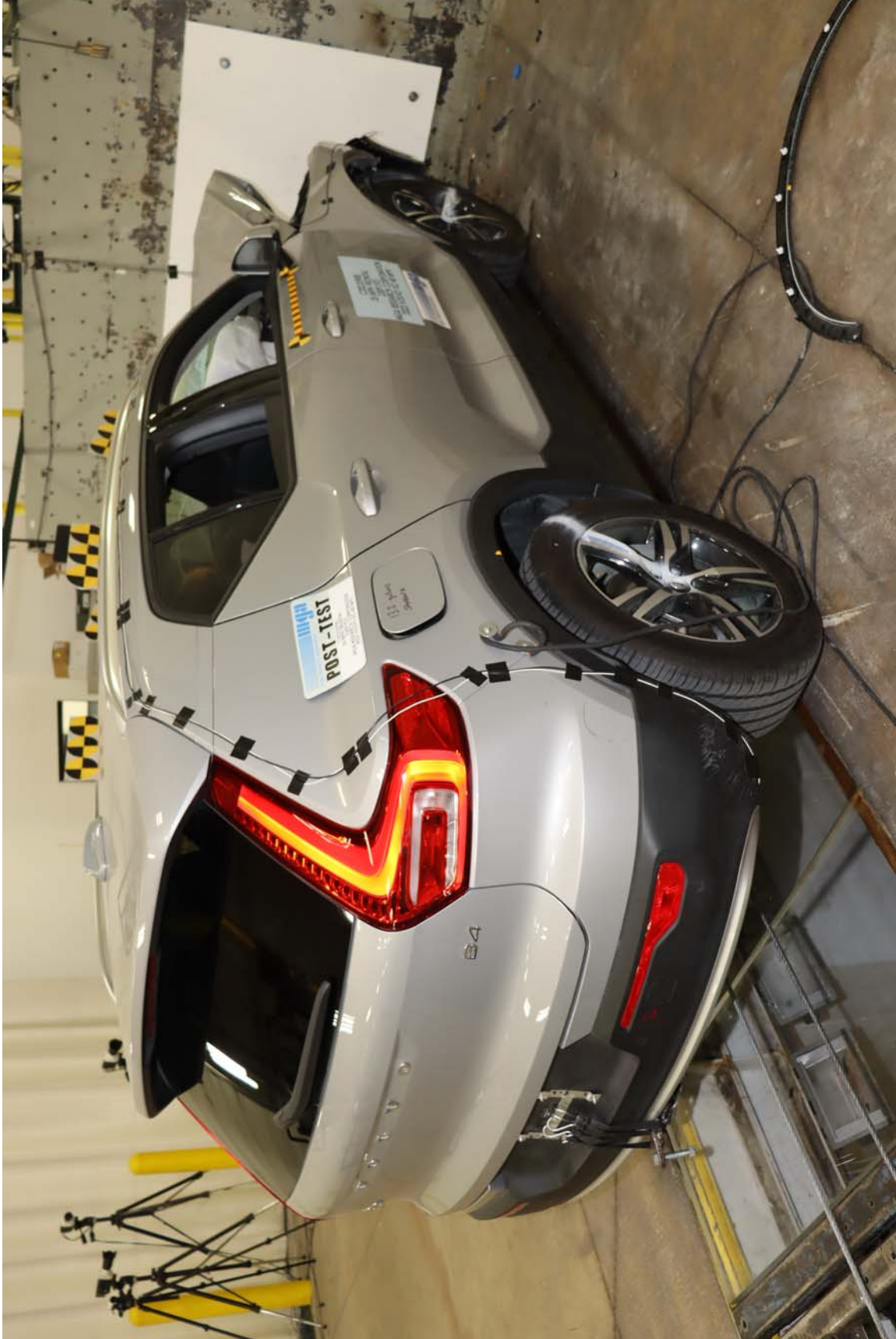

Photo No. 14 - Post-Test Right Rear Three-Quarter View of Test Vehicle

**THIS PHOTO  
IS NOT  
AVAILABLE**

Photo No. 15 - Pre-Test Left Rear Three-Quarter View of Test Vehicle

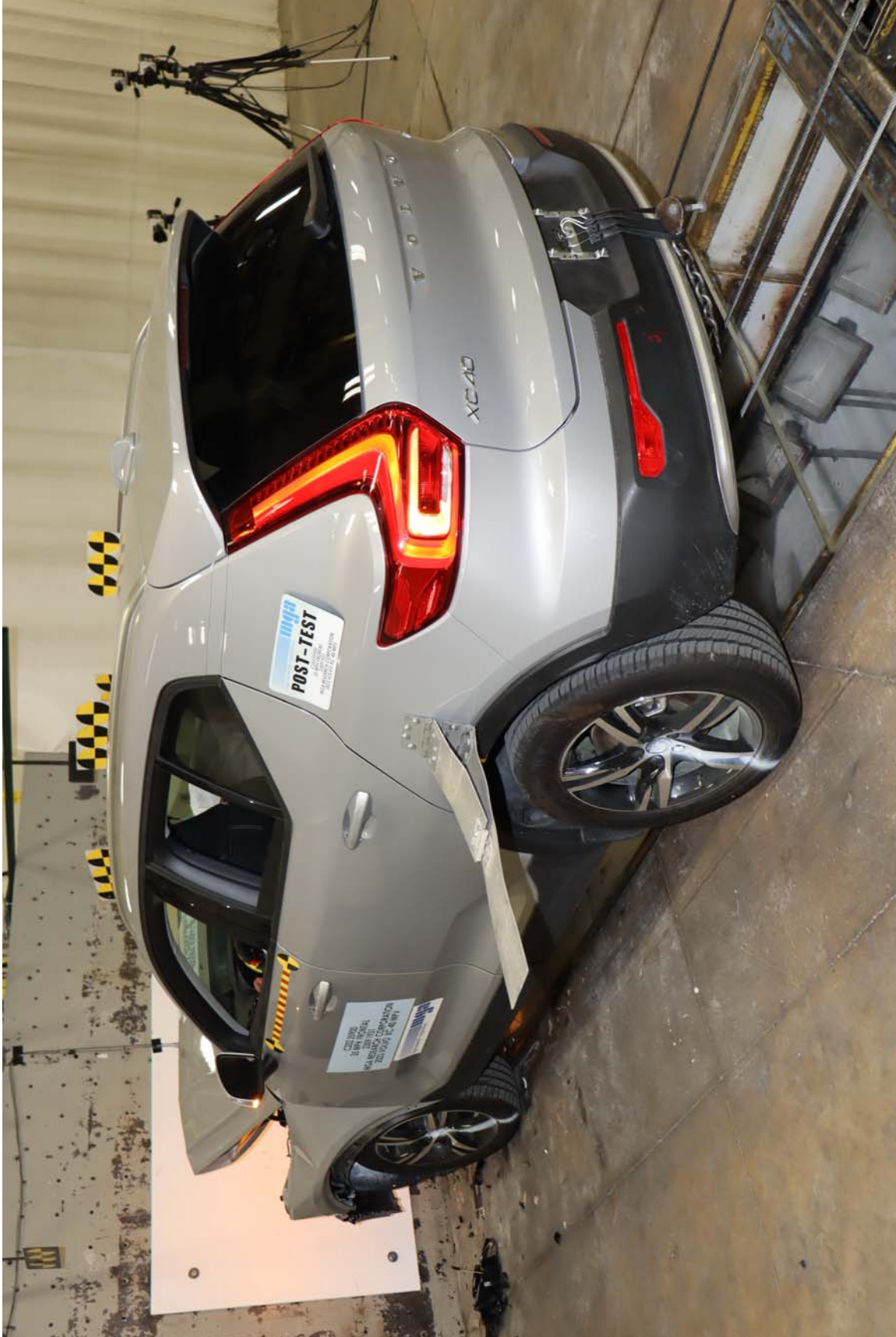

Photo No. 16 - Post-Test Left Rear Three-Quarter View of Test Vehicle







Photo No. 19 - Pre-Test Windshield View



Photo No. 20 - Post-Test Windshield View

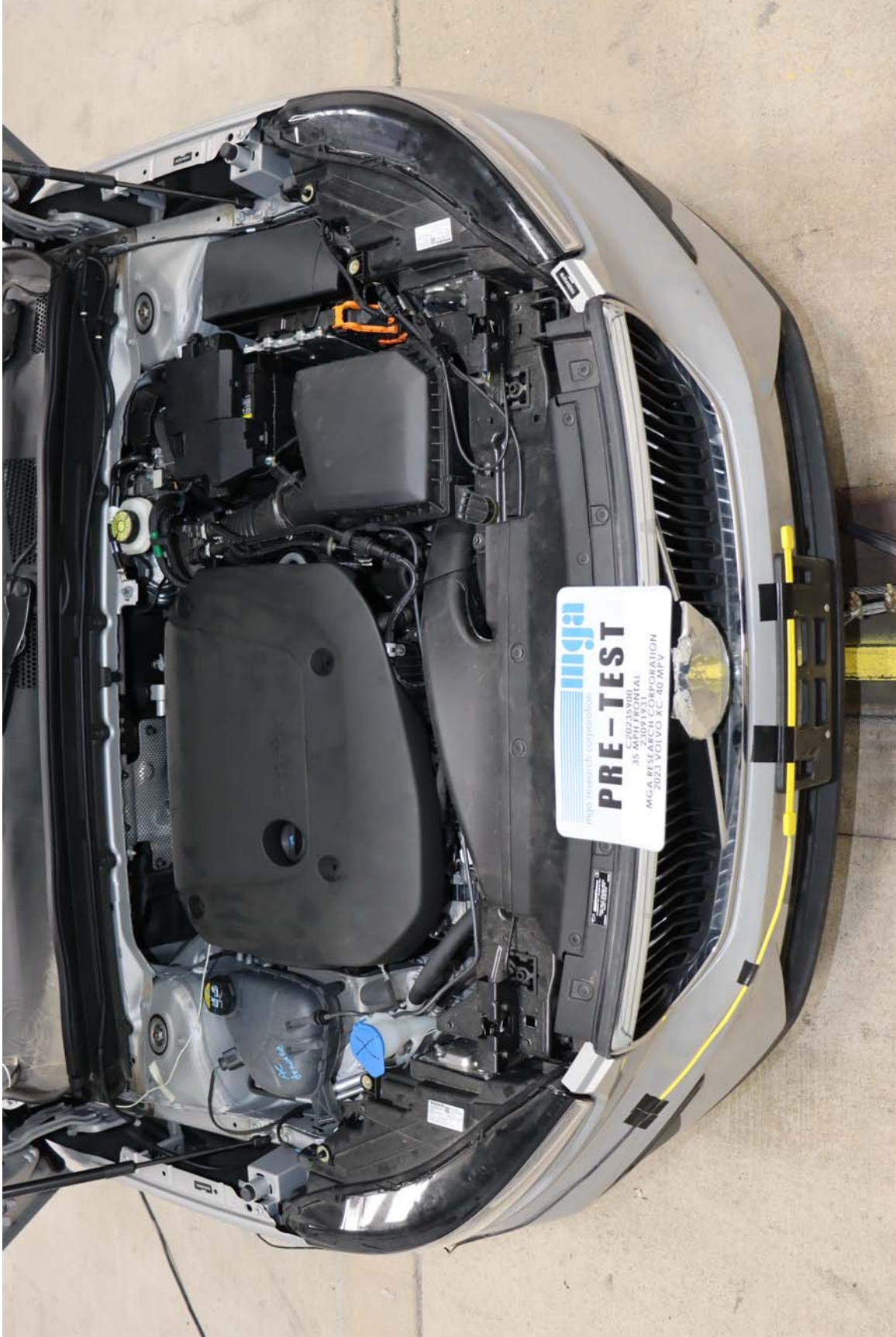

Photo No. 21 - Pre-Test Engine Compartment View



Photo No. 22 - Post-Test Engine Compartment View



Photo No. 23 - Pre-Test Fuel Filler Cap View



Photo No. 24 - Post-Test Fuel Filler Cap View

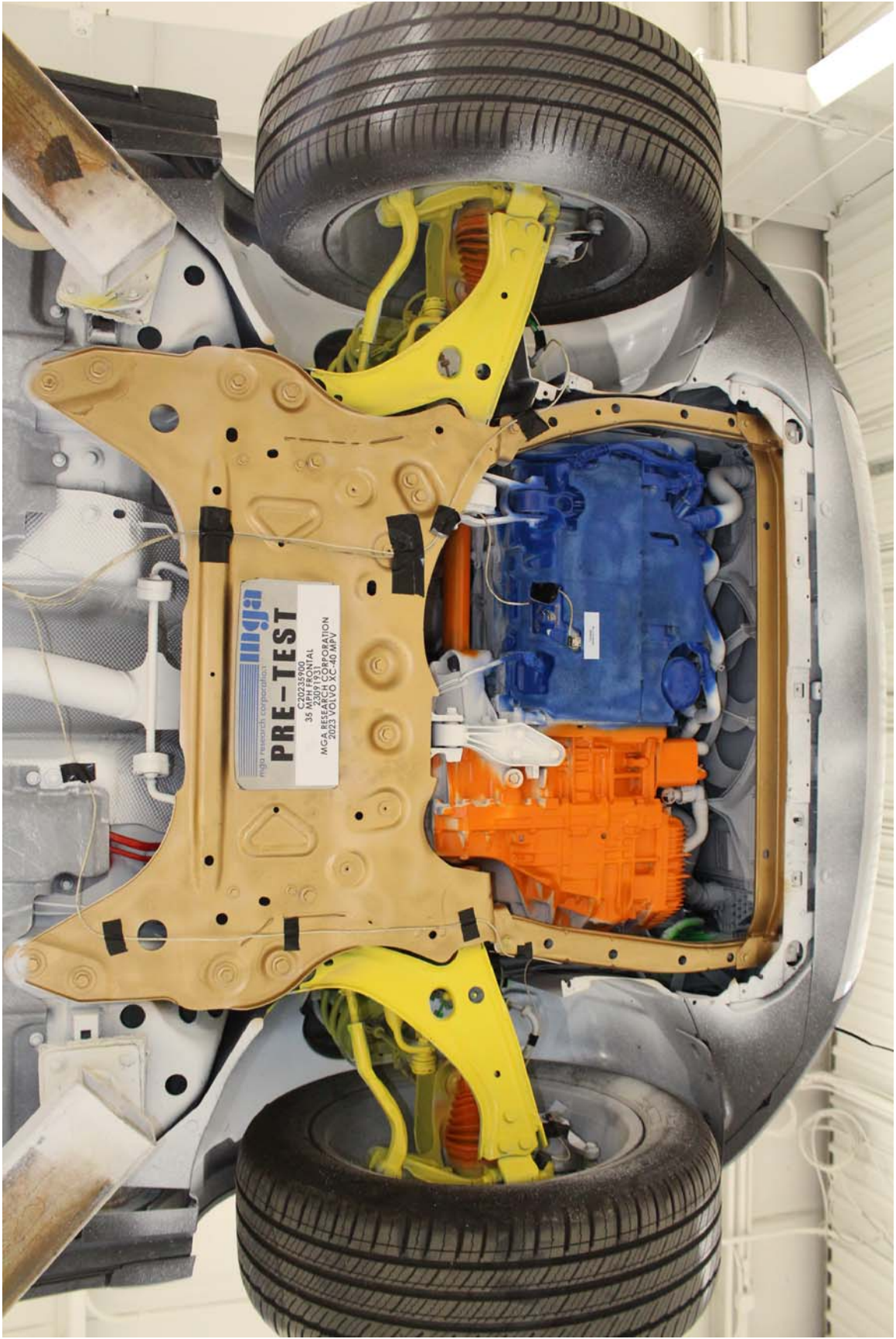
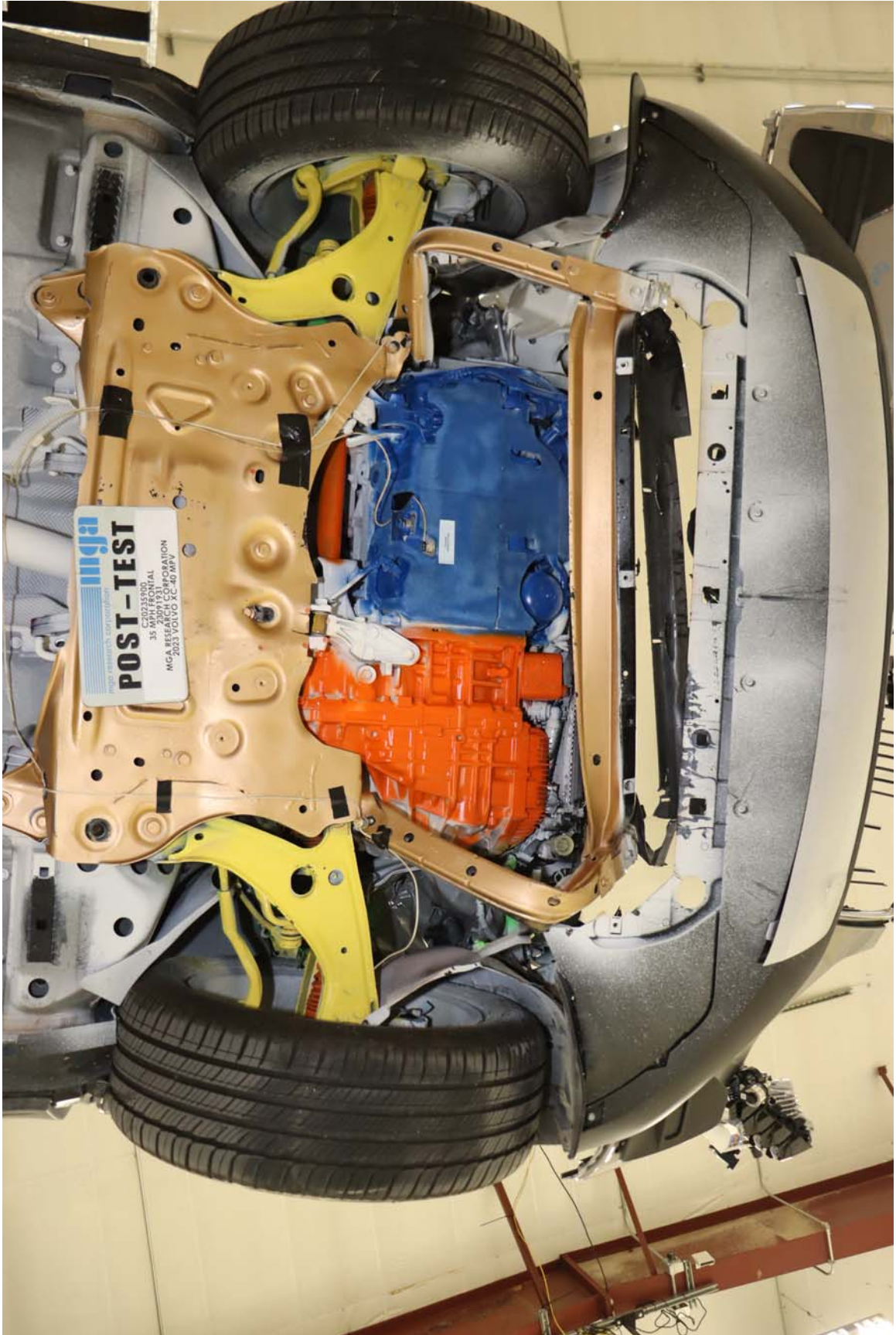

Photo No. 25 - Pre-Test Front Underbody View



**POST-TEST**  
C20735000  
35  
20071131  
MGA, RESARCO SC 40 MPV  
2013 10110 SC 40 MPV

Photo No. 26 - Post-Test Front Underbody View

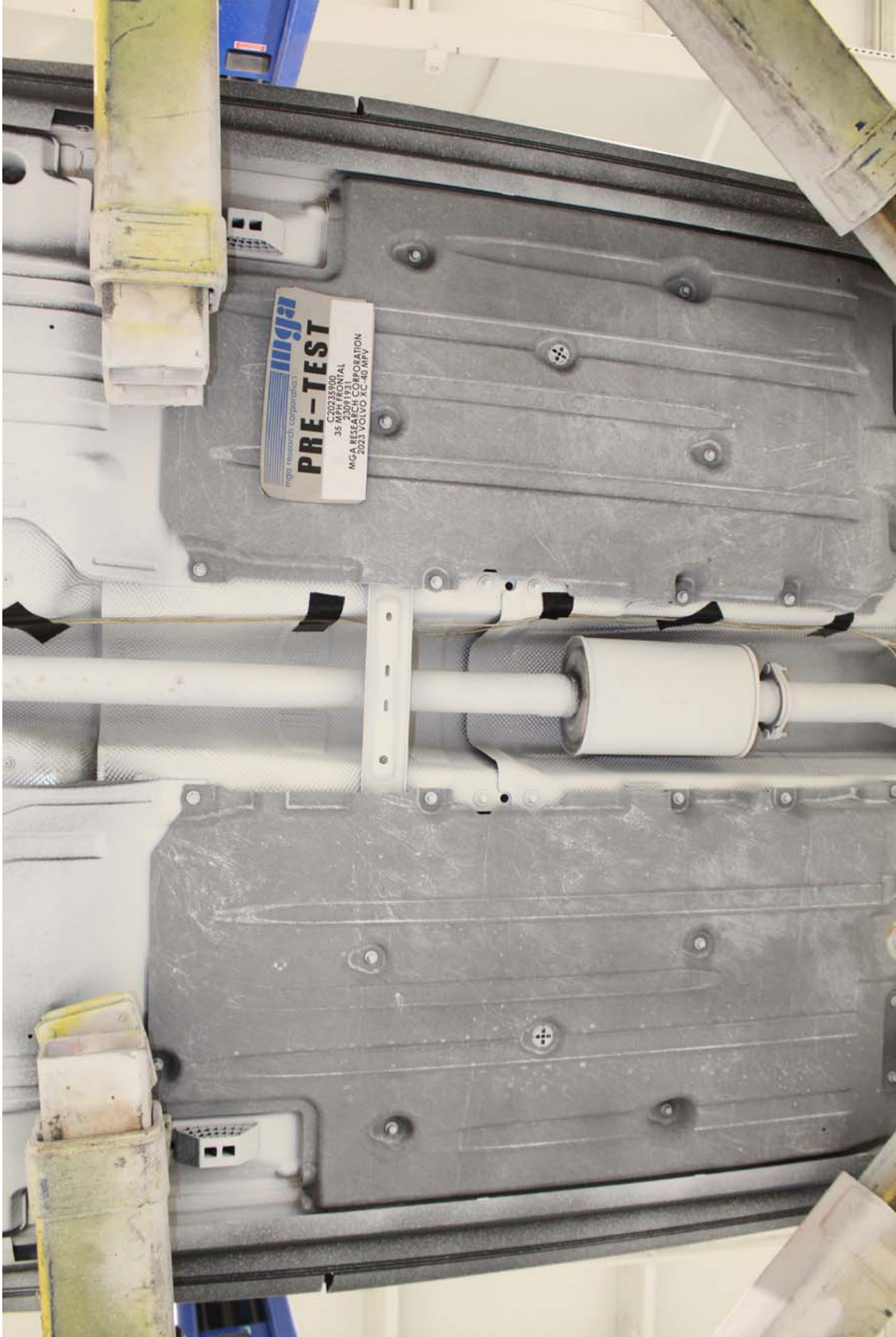

Photo No. 27 - Pre-Test Mid Underbody View

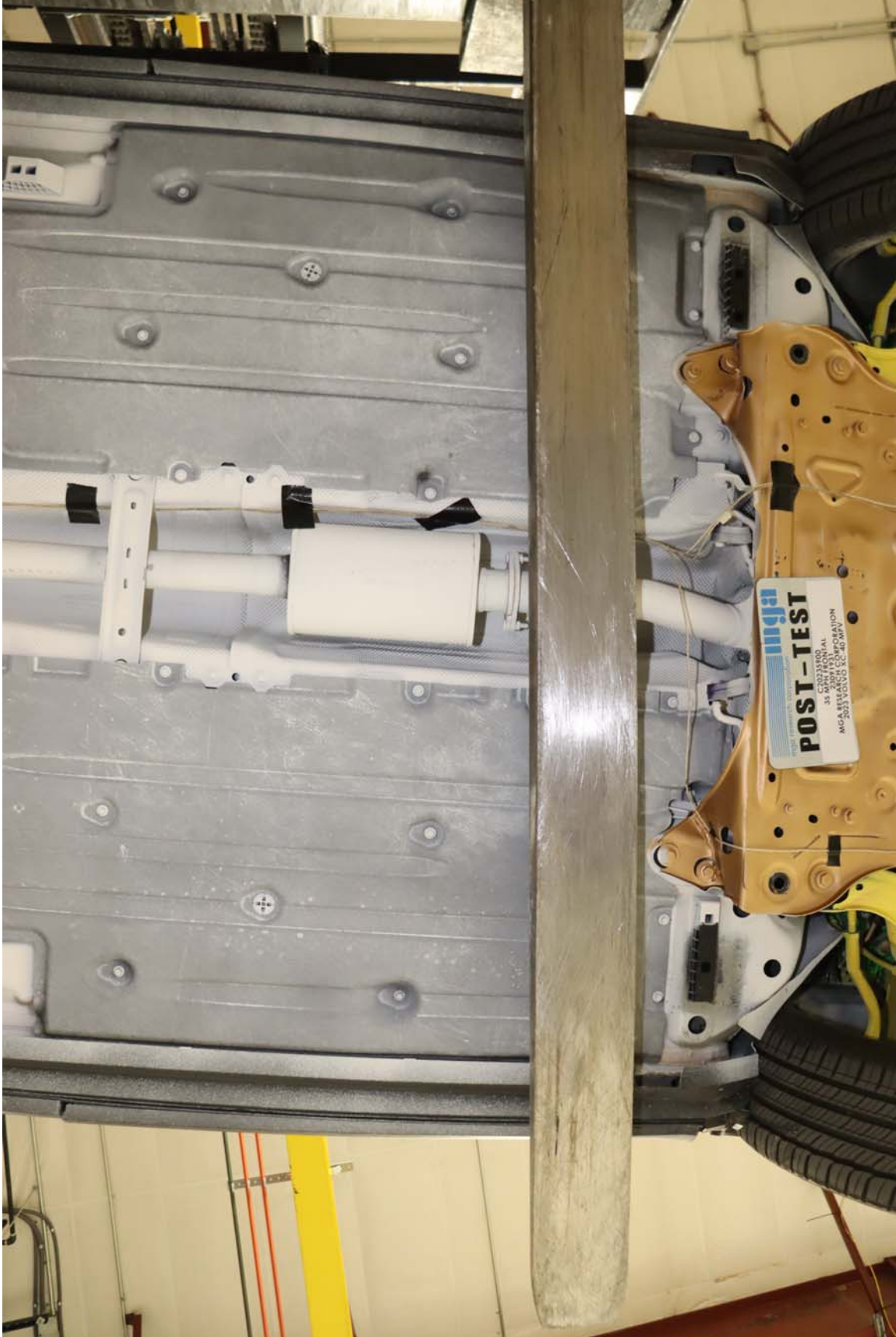

Photo No. 28 - Post-Test Mid Underbody View



Photo No. 29 - Pre-Test Rear Underbody View



Photo No. 30 - Post-Test Rear Underbody View



Photo No. 31 - Pre-Test Driver Dummy Front View (head position)



Photo No. 32 - Post-Test Driver Dummy Front View (head position)



Photo No. 33 - Pre-Test Driver Dummy Position Left Side View



Photo No. 34 - Post-Test Driver Dummy Position Left Side View



Photo No. 35 - Pre-Test Driver Dummy Position Left Side View (door open)



Photo No. 36 - Post-Test Driver Dummy Position Left Side View (door open)



Photo No. 37 - Pre-Test Driver Dummy Seat Position

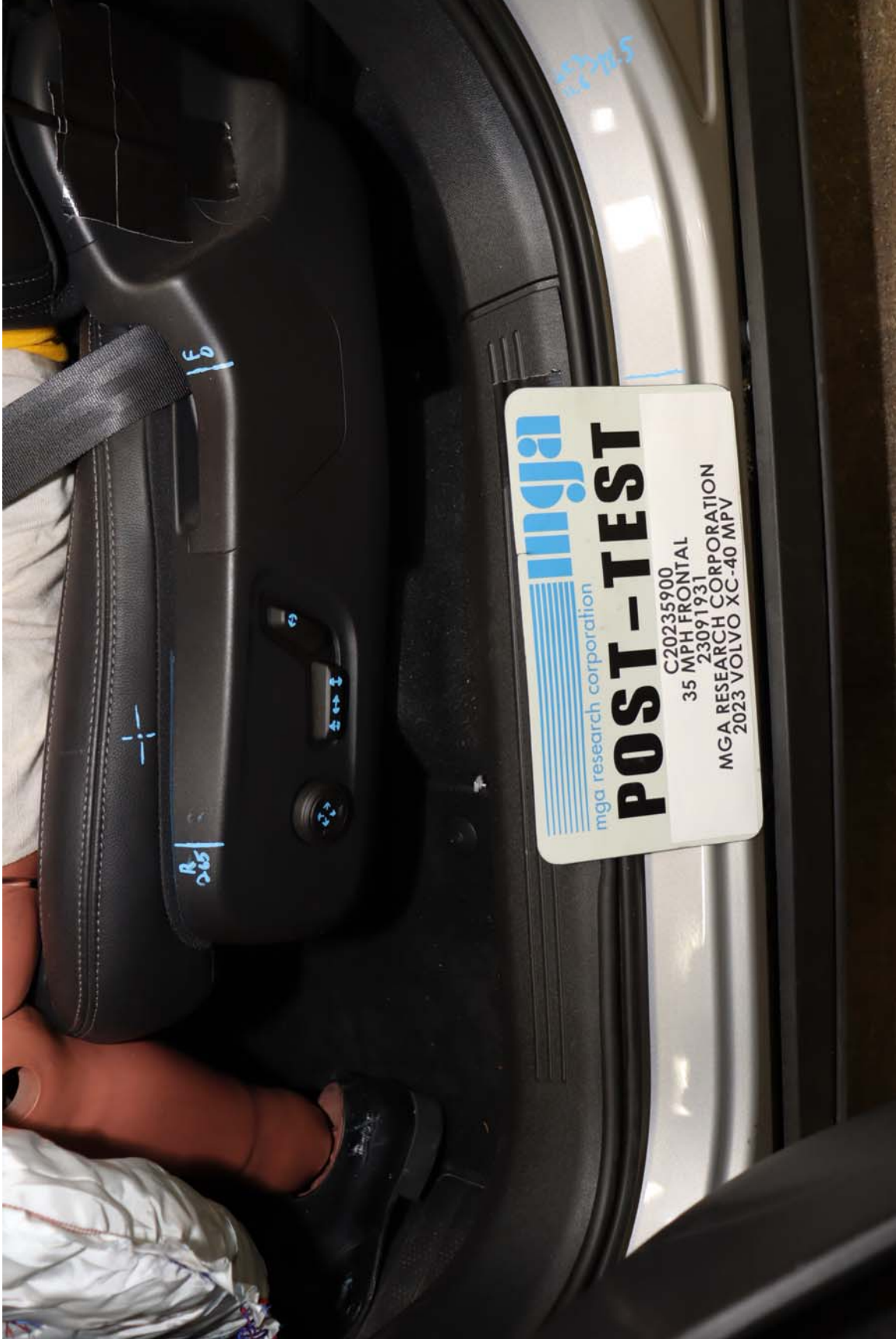

Photo No. 38 - Post-Test Driver Dummy Seat Position



Photo No. 39 - Pre-Test Driver Dummy Feet Position



Photo No. 40 - Post-Test Driver Dummy Feet Position



Photo No. 41 - Pre-Test Driver Side Knee Bolster View



Photo No. 42 - Post-Test Driver Side Knee Bolster View



Photo No. 43 - Post-Test Driver Dummy Airbag Contact



Photo No. 44 - Post-Test Driver Dummy Knee Contact



Photo No. 45 - Post-Test Driver Dummy Head Contact (headrest)



Photo No. 46 - Pre-Test Passenger Dummy Front View (head position)



Photo No. 47 - Post-Test Passenger Dummy Front View (head position)



Photo No. 48 - Pre-Test Passenger Dummy Position Right Side View



Photo No. 49 - Post-Test Passenger Dummy Position Right Side View



Photo No. 50 - Pre-Test Passenger Dummy Position Right Side View (door open)



Photo No. 51 - Post-Test Passenger Dummy Position Right Side View (door open)



Photo No. 52 - Pre-Test Passenger Dummy Seat Position

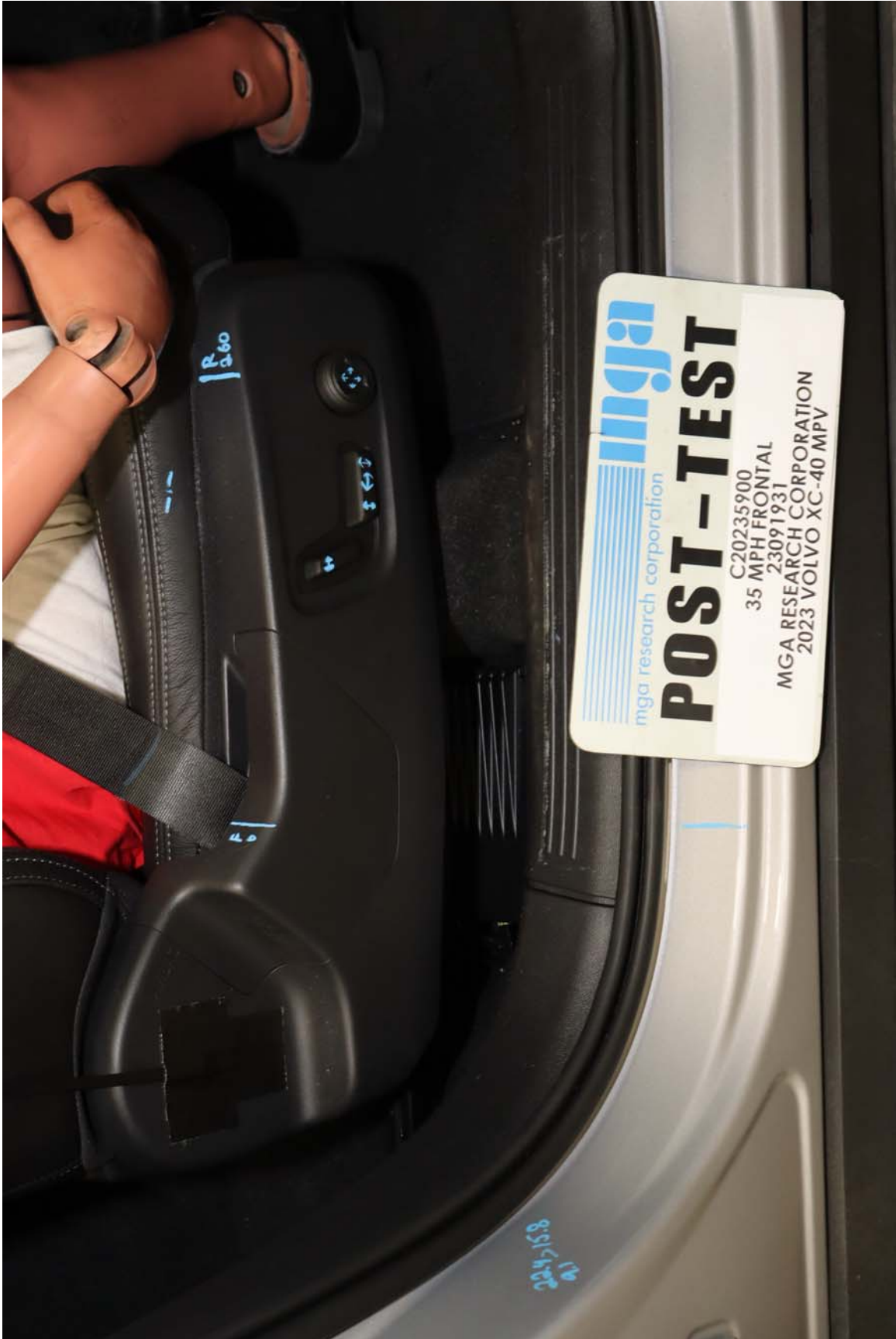

Photo No. 53 - Post-Test Passenger Dummy Seat Position



Photo No. 54 - Pre-Test Passenger Dummy Feet Position



Photo No. 55 - Post-Test Passenger Dummy Feet Position



Photo No. 56 - Pre-Test Passenger Side Knee Bolster View



Photo No. 57 - Post-Test Passenger Side Knee Bolster View



Photo No. 58 - Post-Test Passenger Dummy Airbag Contact



Photo No. 59 - Post-Test Passenger Dummy Knee Contact



Photo No. 60 - Post-Test Passenger Dummy Head Contact (headrest)



Photo No. 61 - Rollover 90 Degrees



Photo No. 62 - Rollover 180 Degrees



Photo No. 63 - Rollover 270 Degrees



Photo No. 64 - Rollover 360 Degrees

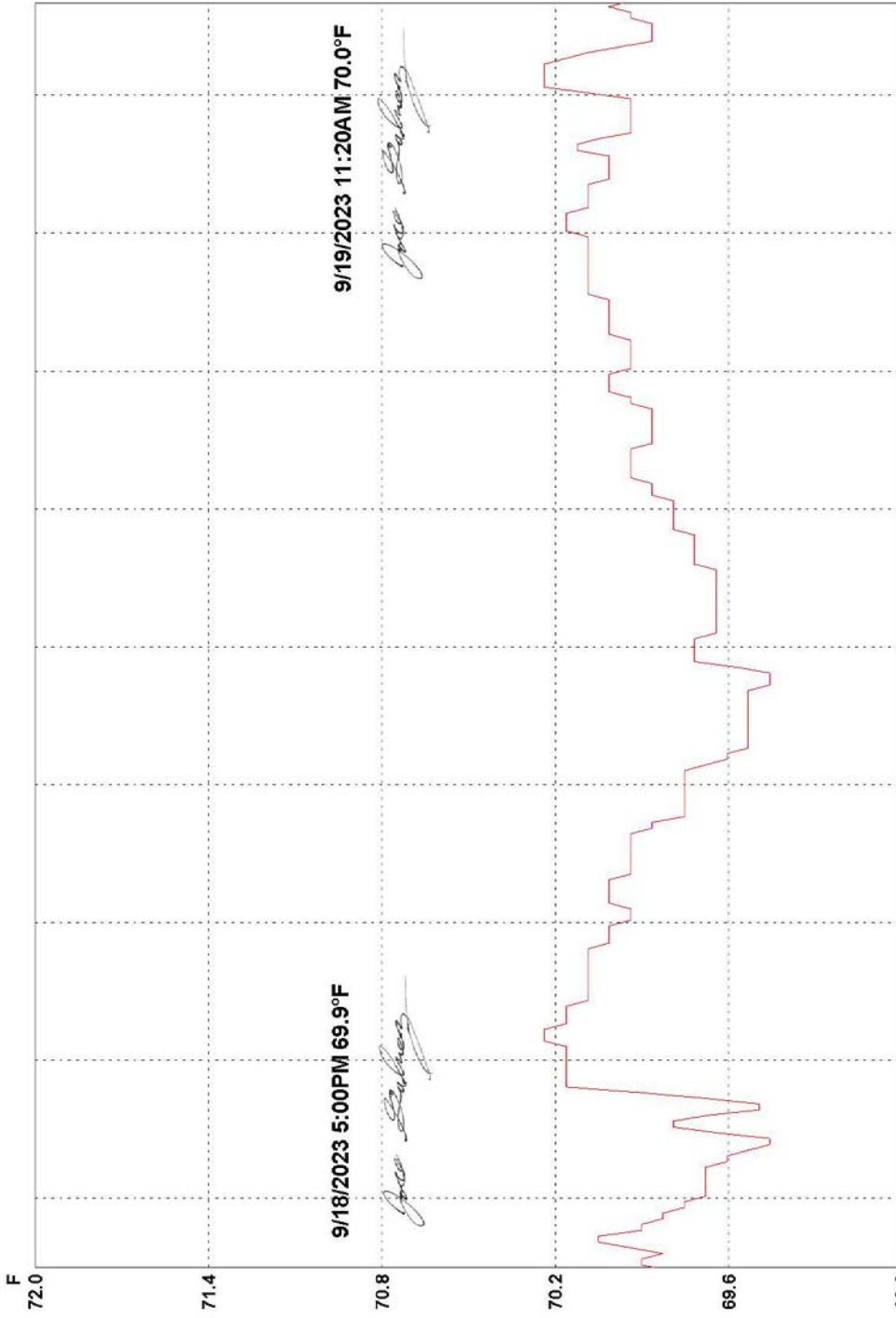

LN	Serial #	Description	CH	Value	Units	CH description	Logger file
1	21282027	VSC_Prep_Room 1	F	Temperature	C20235900	Volvo XC40.spl	

2 hours/div 18:20:00 (M/d/yyyy h:mm:ss tt) Central Time

Graph file (truncated): C20235900 Volvo XC40.spg

Photo No. 65 - Temperature Plot

## APPENDIX D

### LOW RISK PHOTOGRAPHS

#### TABLE OF PHOTOGRAPHS

		<u>Page No.</u>
Photo No. 1.	Pre-Test 5 <sup>th</sup> Fem. P1 Driver Dummy Left Side View	D-1
Photo No. 2.	Post-Test 5 <sup>th</sup> Fem. P1 Driver Dummy Left Side View	D-2
Photo No. 3.	Pre-Test 5 <sup>th</sup> Fem. P1 Driver Dummy Right Side View	D-3
Photo No. 4.	Post-Test 5 <sup>th</sup> Fem. P1 Driver Dummy Right Side View	D-4
Photo No. 5.	Post-Test 5 <sup>th</sup> Fem. P1 Driver Dummy Airbag Left Side View	D-5
Photo No. 6.	Post-Test 5 <sup>th</sup> Fem. P1 Driver Dummy Airbag Right Side View	D-6
Photo No. 7.	Pre-Test 5 <sup>th</sup> Fem. P2 Driver Dummy Left Side View	D-7
Photo No. 8.	Post-Test 5 <sup>th</sup> Fem. P2 Driver Dummy Left Side View	D-8
Photo No. 9.	Pre-Test 5 <sup>th</sup> Fem. P2 Driver Dummy Right Side View	D-9
Photo No. 10.	Post-Test 5 <sup>th</sup> Fem. P2 Driver Dummy Right Side View	D-10
Photo No. 11.	Post-Test 5 <sup>th</sup> Fem. P2 Driver Dummy Airbag Left Side View	D-11
Photo No. 12.	Post-Test 5 <sup>th</sup> Fem. P2 Driver Dummy Airbag Right Side View	D-12
Photo No. 13.	Post-Test 5 <sup>th</sup> Fem. P2 Driver Passenger Dummy Head Contact (visor)	D-13
Photo No. 14.	Pre-Test 3YO P1 Passenger Dummy Left Side View	D-14
Photo No. 15.	Post-Test 3YO P1 Passenger Dummy Left Side View	D-15
Photo No. 16.	Pre-Test 3YO P1 Passenger Dummy Right Side View	D-16
Photo No. 17.	Post-Test 3YO P1 Passenger Dummy Right Side View	D-17
Photo No. 18.	Post-Test 3YO P1 Passenger Dummy Airbag Left Side View	D-18
Photo No. 19.	Post-Test 3YO P1 Passenger Dummy Airbag Right Side View	D-19
Photo No. 20.	Post-Test 3YO P1 Passenger Dummy Head Contact (seat)	D-20
Photo No. 21.	Pre-Test 3YO P2 Passenger Dummy Left Side View	D-21
Photo No. 22.	Post-Test 3YO P2 Passenger Dummy Left Side View	D-22
Photo No. 23.	Pre-Test 3YO P2 Passenger Dummy Right Side View	D-23
Photo No. 24.	Post-Test 3YO P2 Passenger Dummy Right Side View	D-24
Photo No. 25.	Post-Test 3YO P2 Passenger Dummy Airbag Left Side View	D-25
Photo No. 26.	Post-Test 3YO P2 Passenger Dummy Airbag Right Side View	D-26
Photo No. 27.	Post-Test 3YO P2 Passenger Dummy Head Contact (seat back)	D-27
Photo No. 28.	Pre-Test 6YO P1 Passenger Dummy Left Side View	D-28
Photo No. 29.	Post-Test 6YO P1 Passenger Dummy Left Side View	D-29
Photo No. 30.	Pre-Test 6YO P1 Passenger Dummy Right Side View	D-30

Page No.

Photo No. 31.	Post-Test 6YO P1 Passenger Dummy Right Side View	D-31
Photo No. 32.	Post-Test 6YO P1 Passenger Dummy Airbag Left Side View	D-32
Photo No. 33.	Post-Test 6YO P1 Passenger Dummy Airbag Right Side View	D-33
Photo No. 34.	Post-Test 6YO P1 Passenger Dummy Head Contact (seat)	D-34
Photo No. 35.	Pre-Test 6YO P2 Passenger Dummy Left Side View	D-35
Photo No. 36.	Post-Test 6YO P2 Passenger Dummy Left Side View	D-36
Photo No. 37.	Pre-Test 6YO P2 Passenger Dummy Right Side View	D-37
Photo No. 38.	Post-Test 6YO P2 Passenger Dummy Right Side View	D-38
Photo No. 39.	Post-Test 6YO P2 Passenger Dummy Airbag Left Side View	D-39
Photo No. 40.	Post-Test 6YO P2 Passenger Dummy Airbag Right Side View	D-40



Photo No. 1 - Pre-Test 5th Fem. P1 Driver Dummy Left Side View

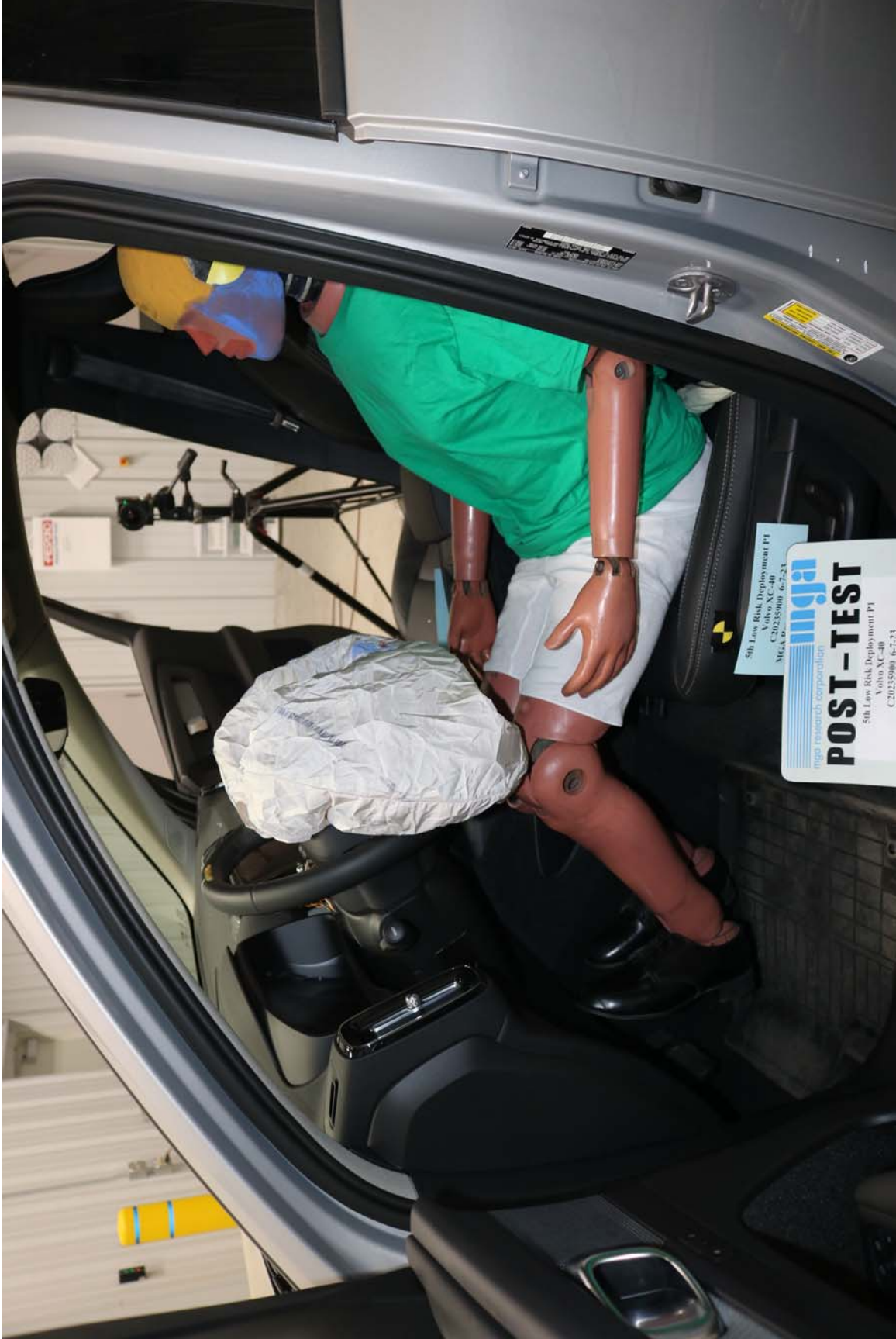

Photo No. 2 - Post-Test 5th Fem. P1 Driver Dummy Left Side View

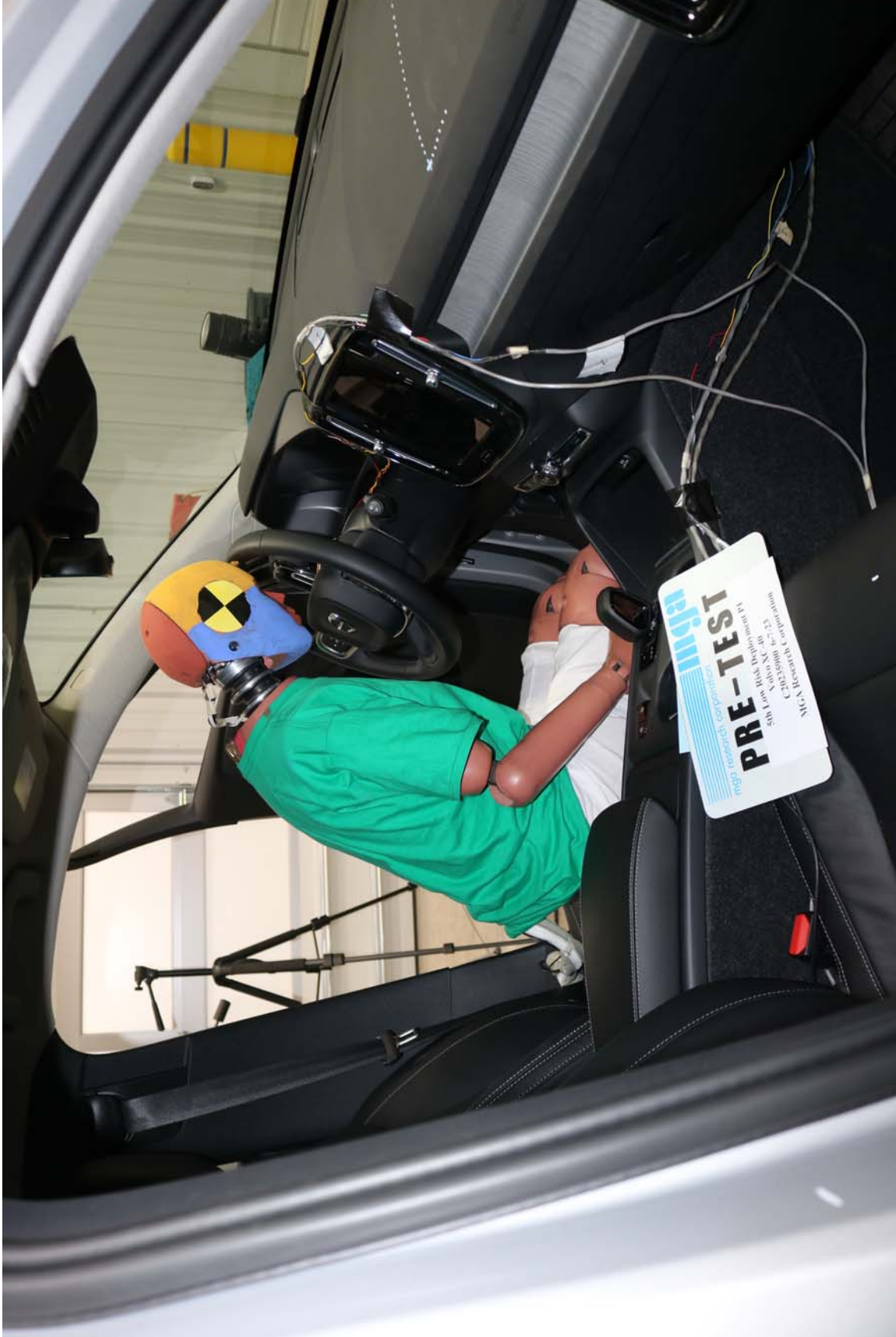

Photo No. 3 - Pre-Test 5th Fem. P1 Driver Dummy Right Side View



Photo No. 4 - Post-Test 5th Fem. P1 Driver Dummy Right Side View



Photo No. 5 - Post-Test 5th Fem. P1 Driver Dummy Airbag Left Side View



Photo No. 6 - Post-Test 5th Fem. P1 Driver Dummy Airbag Right Side View



Photo No. 7 - Pre-Test 5th Fem. P2 Driver Dummy Left Side View



Photo No. 8 - Post-Test 5th Fem. P2 Driver Dummy Left Side View

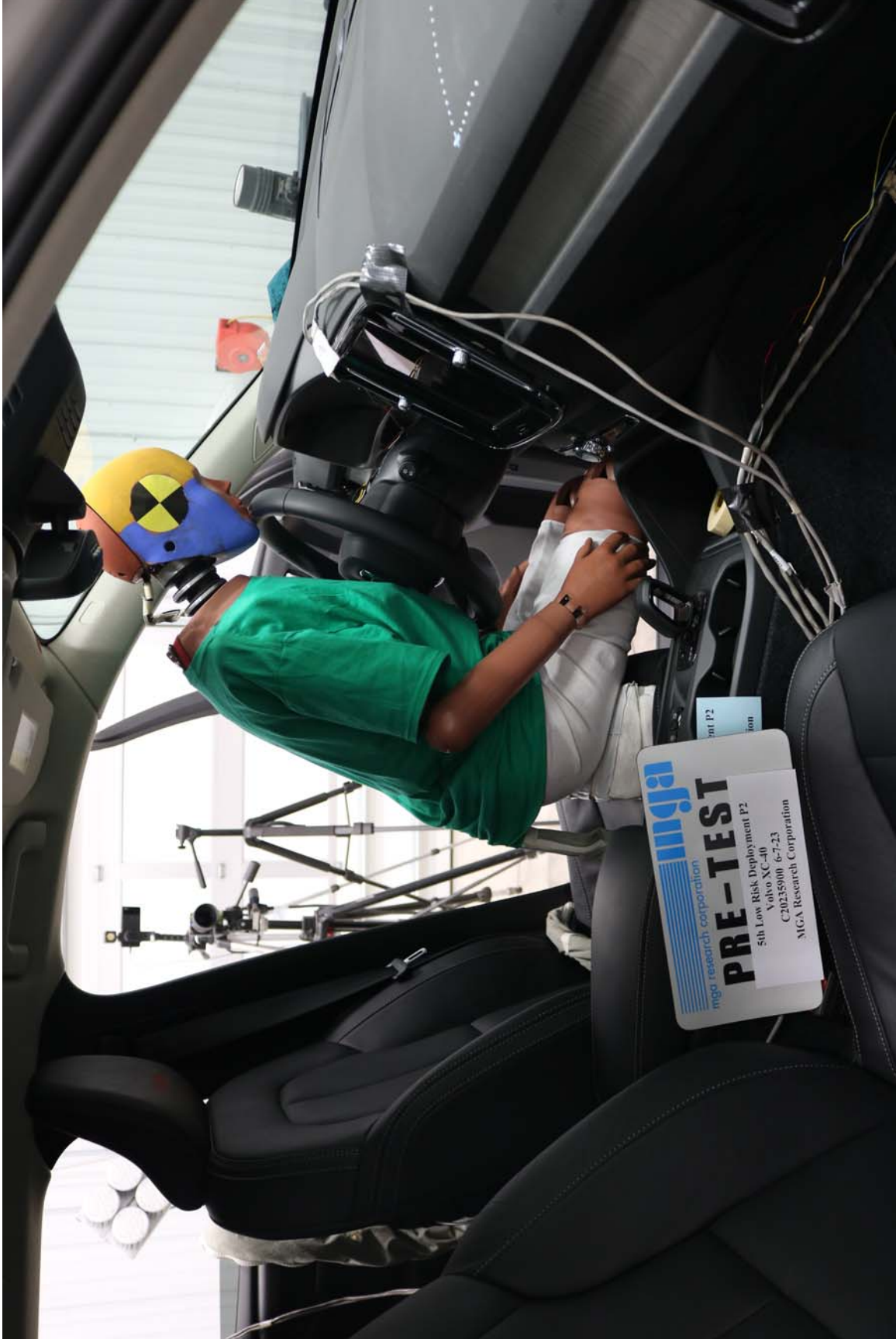

Photo No. 9 - Pre-Test 5th Fem. P2 Driver Dummy Right Side View



Photo No. 10 - Post-Test 5th Fem. P2 Driver Dummy Right Side View



Photo No. 11 - Post-Test 5th Fem. P2 Driver Dummy Airbag Left Side View



Photo No. 12 - Post-Test 5th Fem. P2 Driver Dummy Airbag Right Side View



Photo No. 13 - Post-Test 5th Fem. P2 Driver Dummy Head Contact (visor)



Photo No. 14 - Pre-Test 3YO P1 Passenger Dummy Left Side View



Photo No. 15 - Post-Test 3YO P1 Passenger Dummy Left Side View



Photo No. 16 - Pre-Test 3YO P1 Passenger Dummy Right Side View



Photo No. 17 - Post-Test 3YO P1 Passenger Dummy Right Side View



Photo No. 18 - Post-Test 3YO P1 Passenger Dummy Airbag Left Side View



Photo No. 19 - Post-Test 3YO P1 Passenger Dummy Airbag Right Side View



Photo No. 20 - Post-Test 3YO P1 Passenger Dummy Head Contact (seat)



Photo No. 21 - Pre-Test 3YO P2 Passenger Dummy Left Side View

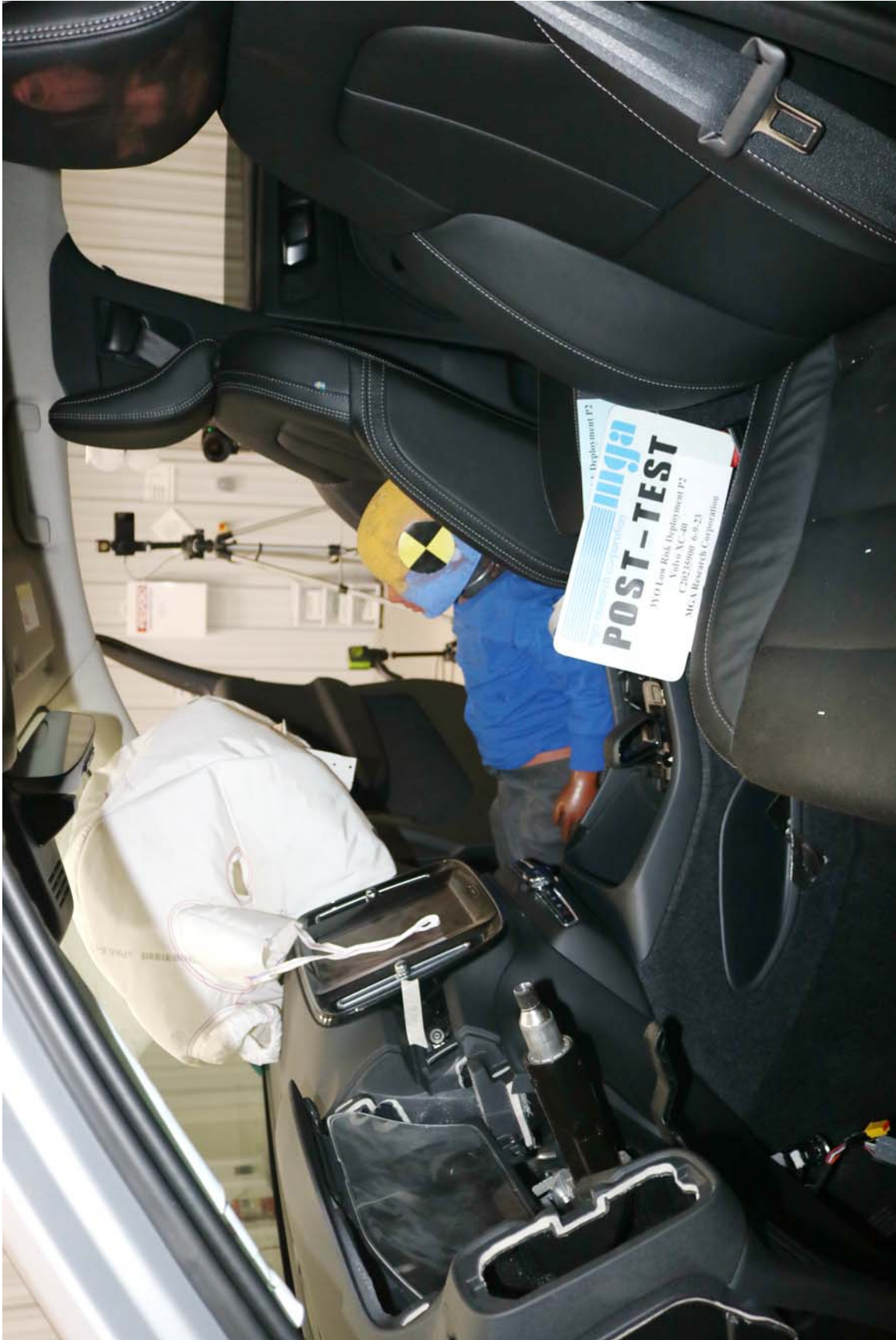

Photo No. 22 - Post-Test 3YO P2 Passenger Dummy Left Side View



Photo No. 23 - Pre-Test 3YO P2 Passenger Dummy Right Side View



Photo No. 24 - Post-Test 3YO P2 Passenger Dummy Right Side View



Photo No. 25 - Post-Test 3YO P2 Passenger Dummy Airbag Left Side View



Photo No. 26 - Post-Test 3YO P2 Passenger Dummy Airbag Right Side View



Photo No. 27 - Post-Test 3YO P2 Passenger Dummy Head Contact (seat back)



Photo No. 28 - Pre-Test 6YO P1 Passenger Dummy Left Side View



Photo No. 29 - Post-Test 6YO P1 Passenger Dummy Left Side View



Photo No. 30 - Pre-Test 6YO P1 Passenger Dummy Right Side View



Photo No. 31 - Post-Test 6YO P1 Passenger Dummy Right Side View



Photo No. 32 - Post-Test 6YO P1 Passenger Dummy Airbag Left Side View



Photo No. 33 - Post-Test 6YO P1 Passenger Dummy Airbag Right Side View



Photo No. 34 - Post-Test 6YO P1 Passenger Dummy Head Contact (seat)



Photo No. 35 - Pre-Test 6YO P2 Passenger Dummy Left Side View



Photo No. 36 - Post-Test 6YO P2 Passenger Dummy Left Side View



Photo No. 37 - Pre-Test 6YO P2 Passenger Dummy Right Side View



Photo No. 38 - Post-Test 6YO P2 Passenger Dummy Right Side View



Photo No. 39 - Post-Test 6YO P2 Passenger Dummy Airbag Left Side View



Photo No. 40 - Post-Test 6YO P2 Passenger Dummy Airbag Right Side View

## APPENDIX E

### SUPPRESSION PHOTOGRAPHS

#### TABLE OF PHOTOGRAPHS

		<u>Page #</u>
Photo No. 1.	Angel Guard Angel Ride Car Bed Belted, Forward Seat Track	E-1
Photo No. 2.	Angel Guard Angel Ride Car Bed Belted, Middle Seat Track	E-1
Photo No. 3.	Angel Guard Angel Ride Car Bed Belted, Rearward Seat Track	E-1
Photo No. 4.	Unbelted 5 <sup>th</sup> Percentile Female Human Reactivation, Forward Seat Track	E-1
Photo No. 5.	Cosco Arriva W/Base, Belted, Rear Facing, Forward Seat Track	E-2
Photo No. 6.	Cosco Arriva W/Base, Belted, Rear Facing, Middle Seat Track	E-2
Photo No. 7.	Cosco Arriva W/Base, Belted, Rear Facing, Rearward Seat Track	E-2
Photo No. 8.	Cosco Arriva W/Base, Unbelted, Rear Facing, Forward Seat Track	E-2
Photo No. 9.	Cosco Arriva W/Base, Unbelted, Rear Facing, Middle Seat Track	E-3
Photo No. 10.	Cosco Arriva W/Base, Unbelted, Rear Facing, Rearward Seat Track	E-3
Photo No. 11.	Cosco Arriva W/Base, Unbelted, Forward Facing, Forward Seat Track	E-3
Photo No. 12.	Cosco Arriva W/Base, Unbelted, Forward Facing, Middle Seat Track	E-3
Photo No. 13.	Cosco Arriva W/Base, Unbelted, Forward Facing, Rearward Seat Track	E-4
Photo No. 14.	Cosco Arriva W/Out Base, Belted, Rear Facing, Forward Seat Track	E-4
Photo No. 15.	Cosco Arriva W/Out Base, Belted, Rear Facing, Middle Seat Track	E-4
Photo No. 16.	Cosco Arriva W/Out Base, Belted, Rear Facing, Rearward Seat Track	E-4
Photo No. 17.	Cosco Arriva W/Out Base, Unbelted, Rear Facing, Forward Seat Track	E-5
Photo No. 18.	Cosco Arriva W/Out Base, Unbelted, Rear Facing, Middle Seat Track	E-5
Photo No. 19.	Cosco Arriva W/Out Base, Unbelted, Rear Facing, Rearward Seat Track	E-5
Photo No. 20.	Cosco Arriva W/Out Base, Unbelted, Forward Facing, Forward Seat Track	E-5
Photo No. 21.	Cosco Arriva W/Out Base, Unbelted, Forward Facing, Middle Seat Track	E-6
Photo No. 22.	Cosco Arriva W/Out Base, Unbelted, Forward Facing, Rearward Seat Track	E-6
Photo No. 23.	Unbelted 5 <sup>th</sup> Percentile Female Human Reactivation, Rearward Seat Track	E-6
Photo No. 24.	Graco Snugride W/Base, Belted, Rear Facing, Forward Seat Track	E-7
Photo No. 25.	Graco Snugride W/Base, Belted, Rear Facing, Middle Seat Track	E-7
Photo No. 26.	Graco Snugride W/Base, Belted, Rear Facing, Rearward Seat Track	E-7
Photo No. 27.	Graco Snugride W/Base, Unbelted, Rear Facing, Forward Seat Track	E-7
Photo No. 28.	Graco Snugride W/Base, Unbelted, Rear Facing, Middle Seat Track	E-8
Photo No. 29.	Graco Snugride W/Base, Unbelted, Rear Facing, Rearward Seat Track	E-8
Photo No. 30.	Graco Snugride W/Base, Unbelted, Forward Facing, Forward Seat Track	E-8
Photo No. 31.	Graco Snugride W/Base, Unbelted, Forward Facing, Middle Seat Track	E-8
Photo No. 32.	Graco Snugride W/Base, Unbelted, Forward Facing, Rearward Seat Track	E-9
Photo No. 33.	Graco Snugride W/Out Base, Belted, Rear Facing, Forward Seat Track	E-9
Photo No. 34.	Graco Snugride W/Out Base, Belted, Rear Facing, Middle Seat Track	E-9

	<u>Page #</u>	
Photo No. 35.	Graco Snugride W/Out Base, Belted, Rear Facing, Rearward Seat Track	E-9
Photo No. 36.	Graco Snugride W/Out Base, Unbelted, Rear Facing, Forward Seat Track	E-10
Photo No. 37.	Graco Snugride W/Out Base, Unbelted, Rear Facing, Middle Seat Track	E-10
Photo No. 38.	Graco Snugride W/Out Base, Unbelted, Rear Facing, Rearward Seat Track	E-10
Photo No. 39.	Graco Snugride W/Out Base, Unbelted, Forward Facing, Forward Seat Track	E-10
Photo No. 40.	Graco Snugride W/Out Base, Unbelted, Forward Facing, Middle Seat Track	E-11
Photo No. 41.	Graco Snugride W/Out Base, Unbelted, Forward Facing, Rearward Seat Track	E-11
Photo No. 42.	Unbelted 5 <sup>th</sup> Percentile Female Human Reactivation, Middle Seat Track	E-11
Photo No. 43.	Peg Perego Viaggio W/Base, Belted, Rear Facing, Forward Seat Track	E-12
Photo No. 44.	Peg Perego Viaggio W/Base, Belted, Rear Facing, Middle Seat Track	E-12
Photo No. 45.	Peg Perego Viaggio W/Base, Belted, Rear Facing, Rearward Seat Track	E-12
Photo No. 46.	Peg Perego Viaggio W/Base, Unbelted, Rear Facing, Forward Seat Track	E-12
Photo No. 47.	Peg Perego Viaggio W/Base, Unbelted, Rear Facing, Middle Seat Track	E-13
Photo No. 48.	Peg Perego Viaggio W/Base, Unbelted, Rear Facing, Rearward Seat Track	E-13
Photo No. 49.	Peg Perego Viaggio W/Base, Unbelted, Forward Facing, Forward Seat Track	E-13
Photo No. 50.	Peg Perego Viaggio W/Base, Unbelted, Forward Facing, Middle Seat Track	E-13
Photo No. 51.	Peg Perego Viaggio W/Base, Unbelted, Forward Facing, Rearward Seat Track	E-14
Photo No. 52.	Peg Perego Viaggio W/Out Base, Belted, Rear Facing, Forward Seat Track	E-14
Photo No. 53.	Peg Perego Viaggio W/Out Base, Belted, Rear Facing, Middle Seat Track	E-14
Photo No. 54.	Peg Perego Viaggio W/Out Base, Belted, Rear Facing, Rearward Seat Track	E-14
Photo No. 55.	Peg Perego Viaggio W/Out Base, Unbelted, Rear Facing, Forward Seat Track	E-15
Photo No. 56.	Peg Perego Viaggio W/Out Base, Unbelted, Rear Facing, Middle Seat Track	E-15
Photo No. 57.	Peg Perego Viaggio W/Out Base, Unbelted, Rear Facing, Rearward Seat Track	E-15
Photo No. 58.	Peg Perego Viaggio W/Out Base, Unbelted, Forward Facing, Forward Seat Track	E-15
Photo No. 59.	Peg Perego Viaggio W/Out Base, Unbelted, Forward Facing, Middle Seat Track	E-16
Photo No. 60.	Peg Perego Viaggio W/Out Base, Unbelted, Forward Facing, Rearward Seat Track	E-16
Photo No. 61.	Unbelted 5 <sup>th</sup> Percentile Female Human Reactivation, Forward Seat Track	E-16
Photo No. 62.	Britax Roundabout Forward Facing Belted, Forward Seat Track	E-17
Photo No. 63.	Britax Roundabout Forward Facing Belted, Middle Seat Track	E-17
Photo No. 64.	Britax Roundabout Forward Facing Belted, Rearward Seat Track	E-17
Photo No. 65.	Britax Roundabout Forward Facing Unbelted, Forward Seat Track	E-17
Photo No. 66.	Britax Roundabout Forward Facing Unbelted, Middle Seat Track	E-18
Photo No. 67.	Britax Roundabout Forward Facing Unbelted, Rearward Seat Track	E-18
Photo No. 68.	Britax Roundabout Rear Facing Belted, Forward Seat Track	E-18
Photo No. 69.	Britax Roundabout Rear Facing Belted, Middle Seat Track	E-18
Photo No. 70.	Britax Roundabout Rear Facing Belted, Rearward Seat Track	E-19
Photo No. 71.	Britax Roundabout Rear Facing Unbelted, Forward Seat Track	E-19
Photo No. 72.	Britax Roundabout Rear Facing Unbelted, Middle Seat Track	E-19

	<u>Page #</u>	
Photo No. 73.	Britax Roundabout Rear Facing Unbelted, Rearward Seat Track	E-19
Photo No. 74.	Unbelted 5 <sup>th</sup> Percentile Female Human Reactivation, Forward Seat Track	E-20
Photo No. 75.	Cosco Summit Deluxe Forward Facing Belted, Forward Seat Track	E-21
Photo No. 76.	Cosco Summit Deluxe Forward Facing Belted, Middle Seat Track	E-21
Photo No. 77.	Cosco Summit Deluxe Forward Facing Belted, Rearward Seat Track	E-21
Photo No. 78.	Cosco Summit Deluxe Forward Facing Unbelted, Forward Seat Track	E-21
Photo No. 79.	Cosco Summit Deluxe Forward Facing Unbelted, Middle Seat Track	E-22
Photo No. 80.	Cosco Summit Deluxe Forward Facing Unbelted, Rearward Seat Track	E-22
Photo No. 81.	Cosco Summit Deluxe Rear Facing Unbelted, Forward Seat Track	E-22
Photo No. 82.	Cosco Summit Deluxe Rear Facing Unbelted, Middle Seat Track	E-22
Photo No. 83.	Cosco Summit Deluxe Rear Facing Unbelted, Middle Seat Track	E-23
Photo No. 84.	Unbelted 5 <sup>th</sup> Percentile Female Human Reactivation, Middle Seat Track	E-23
Photo No. 85.	Evenflo Tribute Forward Facing Belted, Forward Seat Track	E-24
Photo No. 86.	Evenflo Tribute Forward Facing Belted, Middle Seat Track	E-24
Photo No. 87.	Evenflo Tribute Forward Facing Belted, Rearward Seat Track	E-24
Photo No. 88.	Evenflo Tribute Forward Facing Unbelted, Forward Seat Track	E-24
Photo No. 89.	Evenflo Tribute Forward Facing Unbelted, Middle Seat Track	E-25
Photo No. 90.	Evenflo Tribute Forward Facing Unbelted, Rearward Seat Track	E-25
Photo No. 91.	Evenflo Tribute Rear Facing Belted, Forward Seat Track	E-25
Photo No. 92.	Evenflo Tribute Rear Facing Belted, Middle Seat Track	E-25
Photo No. 93.	Evenflo Tribute Rear Facing Belted, Rearward Seat Track	E-26
Photo No. 94.	Evenflo Tribute Rear Facing Unbelted, Forward Seat Track	E-26
Photo No. 95.	Evenflo Tribute Rear Facing Unbelted, Middle Seat Track	E-26
Photo No. 96.	Evenflo Tribute Rear Facing Unbelted, Rearward Seat Track	E-26
Photo No. 97.	Unbelted 5 <sup>th</sup> Percentile Female Human Reactivation, Rearward Seat Track	E-27
Photo No. 98.	Graco Toddler SafeSeat Step 2 Forward Facing Belted, Forward Seat Track	E-28
Photo No. 99.	Graco Toddler SafeSeat Step 2 Forward Facing Belted, Middle Seat Track	E-28
Photo No. 100.	Graco Toddler SafeSeat Step 2 Forward Facing Belted, Rearward Seat Track	E-28
Photo No. 101.	Graco Toddler SafeSeat Step 2 Forward Facing Unbelted, Forward Seat Track	E-28
Photo No. 102.	Graco Toddler SafeSeat Step 2 Forward Facing Unbelted, Middle Seat Track	E-29
Photo No. 103.	Graco Toddler SafeSeat Step 2 Forward Facing Unbelted, Rearward Seat Track	E-29
Photo No. 104.	Graco Toddler SafeSeat Step 2 Rear Facing Unbelted, Forward Seat Track	E-29
Photo No. 105.	Graco Toddler SafeSeat Step 2 Rear Facing Unbelted, Middle Seat Track	E-29
Photo No. 106.	Graco Toddler SafeSeat Step 2 Rear Facing Unbelted, Rearward Seat Track	E-30
Photo No. 107.	Unbelted 5 <sup>th</sup> Percentile Female Human Reactivation, Rearward Seat Track	E-30



Angel Guard Ride Car Bed Belted, Forward Seat Track



Angel Guard Ride Car Bed Belted, Middle Seat Track



Angel Guard Ride Car Bed Belted, Rearward Seat Track



Unbelted 5th Percentile Female Human Reactivation, Forward Seat Track



Cosco Arriva WBBase, Belted, Rear Facing, Forward Seat Track



Cosco Arriva WBBase, Belted, Rear Facing, Middle Seat Track



Cosco Arriva WBBase, Belted, Rear Facing, Rearward Seat Track



Cosco Arriva WBBase, Unbelted, Rear Facing, Forward Seat Track



Cosco Arriva WBBase, Unbelleted, Rear Facing, Middle Seat Track



Cosco Arriva WBBase, Unbelleted, Rear Facing, Rearward Seat Track



Cosco Arriva WBBase, Unbelleted, Forward Facing, Forward Seat Track



Cosco Arriva WBBase, Unbelleted, Forward Facing, Middle Seat Track



Cosco Arriva WBase, Unbelleted, Forward Facing, Rearward Seat Track



Cosco Arriva WOut Base, Belleted, Rear Facing, Forward Seat Track



Cosco Arriva WOut Base, Belleted, Rear Facing, Middle Seat Track



Cosco Arriva WOut Base, Belleted, Rear Facing, Rearward Seat Track



Cosco Arriva WOut Base, Unbelted, Rear Facing, Forward Seat Track



Cosco Arriva WOut Base, Unbelted, Rear Facing, Middle Seat Track



Cosco Arriva WOut Base, Unbelted, Rear Facing, Rearward Seat Track



Cosco Arriva WOut Base, Unbelted, Forward Facing, Forward Seat Track



Cosco Arriva W/Out Base, Unbelted, Forward Facing, Middle Seat Track



Cosco Arriva W/Out Base, Unbelted, Forward Facing, Rearward Seat Track



Unbelted 5th Percentile Female Human Reactivation, Rearward Seat Track



Graco Snugride WBBase, Belted, Rear Facing, Forward Seat Track



Graco Snugride WBBase, Belted, Rear Facing, Rearward Seat Track



Graco Snugride WBBase, Belted, Rear Facing, Middle Seat Track



Graco Snugride WBBase, Unbelted, Rear Facing, Forward Seat Track



Graco Snugride WBase, Unbelted, Rear Facing, Middle Seat Track



Graco Snugride WBase, Unbelted, Rear Facing, Rearward Seat Track



Graco Snugride WBase, Unbelted, Forward Facing, Middle Seat Track



Graco Snugride WBase, Unbelted, Forward Facing, Middle Seat Track



Graco Snugride WB Base, Unbelted, Forward Facing, Rearward Seat Track



Graco Snugride WOut Base, Belted, Rear Facing, Forward Seat Track



Graco Snugride WOut Base, Belted, Rear Facing, Middle Seat Track



Graco Snugride WOut Base, Belted, Rear Facing, Rearward Seat Track



Graco Snugride WOut Base, Unbelted, Rear Facing, Forward Seat Track



Graco Snugride WOut Base, Unbelted, Rear Facing, Middle Seat Track



Graco Snugride WOut Base, Unbelted, Rear Facing, Rearward Seat Track



Graco Snugride WOut Base, Unbelted, Forward Facing, Forward Seat Track



Graco Snugride WOut Base, Unbelted, Forward Facing, Middle Seat Track



Graco Snugride WOut Base, Unbelted, Forward Facing, Rearward Seat Track



Unbelted 5th Percentile Female Human Reactivation, Middle Seat Track



Peg Perego Viaggio WBase, Belted, Rear Facing, Forward Seat Track



Peg Perego Viaggio WBase, Belted, Rear Facing, Middle Seat Track



Peg Perego Viaggio WBase, Belted, Rear Facing, Rearward Seat Track



Peg Perego Viaggio WBase, Unbelted, Rear Facing, Forward Seat Track



Peg Perego Viaggio WBase, Unbelted, Rear Facing, Middle Seat Track



Peg Perego Viaggio WBase, Unbelted, Rear Facing, Rearward Seat Track



Peg Perego Viaggio WBase, Unbelted, Forward Facing, Middle Seat Track



Peg Perego Viaggio WBase, Unbelted, Forward Facing, Middle Seat Track



Peg Perego Viaggio WBase, Unbelted, Forward Facing, Rearward Seat Track



Peg Perego Viaggio WOut Base, Belted, Rear Facing, Forward Seat Track



Peg Perego Viaggio WOut Base, Belted, Rear Facing, Middle Seat Track



Peg Perego Viaggio WOut Base, Belted, Rear Facing, Rearward Seat Track



Peg Perego Viaggio WOut Base, Unbelleted, Rear Facing, Forward Seat Track



Peg Perego Viaggio WOut Base, Unbelleted, Rear Facing, Middle Seat Track



Peg Perego Viaggio WOut Base, Unbelleted, Rear Facing, Rearward Seat Track



Peg Perego Viaggio WOut Base, Unbelleted, Forward Facing, Forward Seat Track



Peg Perego Viaggio WOut Base, Unbelted, Forward Facing, Middle Seat Track



Peg Perego Viaggio WOut Base, Unbelted, Forward Facing, Rearward Seat Track



Unbelted 5th Percentile Female Human Reactivation, Forward Seat Track



Britax Roundabout Forward Facing Belted, Forward Seat Track



Britax Roundabout Forward Facing Belted, Middle Seat Track



Britax Roundabout Forward Facing Belted, Rearward Seat Track



Britax Roundabout Forward Facing Unbelted, Forward Seat Track



Britax Roundabout Forward Facing Unbelted, Middle Seat Track



Britax Roundabout Forward Facing Unbelted, Rearward Seat Track



Britax Roundabout Rear Facing Belted, Forward Seat Track



Britax Roundabout Rear Facing Belted, Middle Seat Track



Britax Roundabout Rear Facing Belted, Rearward Seat Track



Britax Roundabout Rear Facing Unbelted, Forward Seat Track



Britax Roundabout Rear Facing Unbelted, Middle Seat Track



Britax Roundabout Rear Facing Unbelted, Rearward Seat Track



Unbelted 5th Percentile Female Human Reactivation, Forward Seat Track



Cosco Summit Deluxe Forward Facing Belted, Forward Seat Track



Cosco Summit Deluxe Forward Facing Belted, Middle Seat Track



Cosco Summit Deluxe Forward Facing Belted, Rearward Seat Track



Cosco Summit Deluxe Forward Facing Unbelted, Forward Seat Track



Cosco Summit Deluxe Forward Facing Unbelted, Middle Seat Track



Cosco Summit Deluxe Rear Facing Unbelted, Forward Seat Track



Cosco Summit Deluxe Forward Facing Unbelted, Rearward Seat Track



Cosco Summit Deluxe Rear Facing Unbelted, Middle Seat Track



Cosco Summit Deluxe Rear Facing Unbelleted, Rearward Seat Track



Unbelleted 5th Percentile Female Human Reactivation, Middle Seat Track



Evenflo Tribute Forward Facing Belted, Forward Seat Track



Evenflo Tribute Forward Facing Belted, Middle Seat Track



Evenflo Tribute Forward Facing Belted, Rearward Seat Track



Evenflo Tribute Forward Facing Unbelted, Forward Seat Track



Evenflo Tribute Forward Facing Unbelleted, Middle Seat Track



Evenflo Tribute Rear Facing Belleted, Forward Seat Track



Evenflo Tribute Forward Facing Unbelleted, Rearward Seat Track



Evenflo Tribute Rear Facing Belleted, Middle Seat Track



Evenflo Tribute Rear Facing Belted, Rearward Seat Track



Evenflo Tribute Rear Facing Unbelleted, Forward Seat Track



Evenflo Tribute Rear Facing Unbelleted, Middle Seat Track



Evenflo Tribute Rear Facing Unbelleted, Rearward Seat Track



Unbelted 5th Percentile Female Human Reactivation, Rearward Seat Track



Graco Toddler SafeSeat Step 2 Forward Facing Belted, Forward Seat Track



Graco Toddler SafeSeat Step 2 Forward Facing Belted, Middle Seat Track



Graco Toddler SafeSeat Step 2 Forward Facing Belted, Rearward Seat Track



Graco Toddler SafeSeat Step 2 Forward Facing Unbelted, Forward Seat Track



Graco Toddler SafeSeat Step 2 Forward Facing Unbelted, Middle Seat Track



Graco Toddler SafeSeat Step 2 Rear Facing Unbelted, Forward Seat Track



Graco Toddler SafeSeat Step 2 Forward Facing Unbelted, Rearward Seat Track



Graco Toddler SafeSeat Step 2 Rear Facing Unbelted, Middle Seat Track



Graco Toddler SafeSeat Step 2 Rear Facing Unbelleted, Rearward Seat Track



Unbelleted 5th Percentile Female Human Reactivation, Rearward Seat Track

**APPENDIX F**

**INSTRUMENTATION CALIBRATION**

**INSTRUMENTS FOR DRIVER DUMMY NO.: 507**

	SERIAL NO.	MANUFACTURER	CALIBRATION DATE
Head X	P85158	Endevco	08/16/2023
Head Y	P85159	Endevco	08/16/2023
Head Z	P85160	Endevco	08/16/2023
Neck Load Cell	N937	Denton	05/10/2023
Chest X	P79787	Endevco	08/16/2023
Chest Y	T30846	Endevco	08/16/2023
Chest Z	P86735	Endevco	08/16/2023
Chest Displacement	507	Humanetics	08/16/2023
Left Femur Load Cell	F8152	Denton	08/16/2023
Right Femur Load Cell	F8151	Denton	08/16/2023

**INSTRUMENTS FOR PASSENGER DUMMY NO.: 510**

	SERIAL NO.	MANUFACTURER	CALIBRATION DATE
Head X	T24763	Endevco	08/03/2023
Head Y	T24813	Endevco	08/03/2023
Head Z	T24814	Endevco	08/03/2023
Neck Load Cell	N742	Denton	08/09/2023
Chest X	P88334	Endevco	06/05/2023
Chest Y	P88335	Endevco	06/05/2023
Chest Z	P93609	Endevco	06/05/2023
Chest Displacement	510	Humanetics	06/05/2023
Left Femur Load Cell	F1827	Denton	06/05/2023
Right Femur Load Cell	F1826	Denton	06/05/2023

**INSTRUMENTS FOR LOW RISK 5<sup>TH</sup> FEMALE DUMMY NO.: 510 (P1 & P2)**

	SERIAL NO.	MANUFACTURER	CALIBRATION DATE
Head X	P79575	Endevco	06/05/2023
Head Y	P79577	Endevco	06/05/2023
Head Z	P79578	Endevco	06/05/2023
Neck Load Cell	N2039	Denton	04/05/2023
Chest X	P88334	Endevco	06/05/2023
Chest Y	P88335	Endevco	06/05/2023
Chest Z	P93609	Endevco	06/05/2023
Chest Displacement	510	Humanetics	06/05/2023
Left Femur Load Cell	F1827	Denton	06/05/2023
Right Femur Load Cell	F1826	Denton	06/05/2023

**INSTRUMENTS FOR LOW RISK 3 YEAR OLD DUMMY NO.: 031 (P1 & P2)**

	SERIAL NO.	MANUFACTURER	CALIBRATION DATE
Head X	P85701	Endevco	05/24/2023
Head Y	P88338	Endevco	05/24/2023
Head Z	T26458	Endevco	05/24/2023
Neck Load Cell	N184	Denton	05/05/2023
Chest X	T18417	Endevco	05/24/2023
Chest Y	T22265	Endevco	05/24/2023
Chest Z	T24803	Endevco	05/24/2023
Chest Displacement	031	Humanetics	05/31/2023

**INSTRUMENTS FOR LOW RISK 6 YEAR OLD DUMMY NO.: 155 (P1 & P2)**

	SERIAL NO.	MANUFACTURER	CALIBRATION DATE
Head X	P79723	Endevco	05/24/2023
Head Y	P84426	Endevco	05/24/2023
Head Z	P84428	Endevco	05/24/2023
Neck Load Cell	N253	Denton	05/05/2023
Chest X	P88330	Endevco	05/24/2023
Chest Y	P88331	Endevco	05/24/2023
Chest Z	P88332	Endevco	05/24/2023
Chest Displacement	155	Humanetics	05/31/2023

**VEHICLE INSTRUMENTS**

	SERIAL NO.	MANUFACTURER	CALIBRATION DATE
Left Rear Seat Crossmember X	A383761	MSI	09/15/2023
Right Rear Seat Crossmember X	A405208	MSI	09/15/2023
Top of Engine X	T33408	Endevco	04/05/2023
Bottom of Engine X	A391134	MSI	06/08/2023
Right Brake Caliper X	A395084	MSI	03/29/2023
Instrument Panel X	T32358	Endevco	04/17/2023
Left Brake Caliper X	A377286	MSI	04/27/2023
Trunk Z	T33142	Endevco	04/17/2023