

REPORT NUMBER TR-P28001-22-NC

**NEW CAR ASSESMENT PROGRAM
FRONTAL BARRIER IMPACT TEST**

**HYUNDAI MOTOR MANUFACTURING ALABAMA,LLC
2009 HYUNDAI SONATA
4-DOOR SEDAN**

NHTSA NUMBER: M90502

**Prepared By:
KARCO ENGINEERING, LLC
9270 HOLLY ROAD
ADELANTO, CALIFORNIA 92301**



AUGUST 22, 2008

FINAL REPORT

**PREPARED FOR:
U.S. DEPARTMENT OF TRANSPORTATION
NATIONAL HIGHWAY TRAFFIC SAFETY ADMINISTRATION
OFFICE OF CRASHWORTHINESS STANDARDS
RULEMAKING
MAIL CODE: NVS-111
1200 NEW JERSEY AVE SE, ROOM W43-410
WASHINGTON, D.C. 20590**

This final test report was prepared for the U.S. Department of Transportation, National Highway Traffic Safety Administration, in response to Contract Number DTNH22-06-D-00027.

This publication is distributed by the U.S. Department of Transportation, National Highway Traffic Safety Administration, in the interest of information exchange. The opinions, findings and conclusions expressed in this publication are those of the author(s) and not necessarily those of the Department of Transportation or the National Highway Traffic Safety Administration. The United States Government assumes no liability for its contents or use thereof. If trade or manufacturers' names or products are mentioned it is only because they are considered essential to the object of the publication and should not be construed as an endorsement. The United States Government does not endorse products or manufacturers.

Prepared by:  Date: August 22, 2008
Mr. Pablo Vega, Project Engineer
KARCO Engineering, LLC

Reviewed by:  Date: August 22, 2008
Mr. Michael L. Dunlap, Director of Operations
KARCO Engineering, LLC

Approved by:  Date: August 22, 2008
Mr. Frank D. Richardson, Program Manager
KARCO Engineering, LLC

FINAL REPORT ACCEPTED BY:

Manager, New Car Assessment Program

Date of Acceptance

COTR, NCAP Frontal Impact Program

Date of Acceptance

Technical Report Documentation Page

1. Report No. TR-P28001-22-NC	2. Government Accession No.	3. Recipients Catalog No.																											
4. Title and Subtitle Final Report of New Car Assessment Program Testing of a 2009 Hyundai Sonata 4-Door Sedan NHTSA No. M90502		5. Report Date August 22, 2008																											
		6. Performing Organization Code KAR																											
7. Authors Mr. Pablo Vega, Project Engineer, KARCO Mr. Frank Richardson, Program Manager, KARCO		8. Performing Organization Report No. TR-P28001-22-NC																											
		9. Performing Organization Name and Address Karco Engineering, LLC 9270 Holly Rd. Adelanto, CA, 92301																											
12. Sponsoring Agency Name and Address U. S. Department of Transportation National Highway Traffic Safety Administration Rulemaking Office of Crashworthiness Standards Mail Code NVS-111 1200 New Jersey Ave., SE, Room W43-410 Washington, D.C 20590		10. Work Unit No.																											
		11. Contract or Grant No. DTNH22-06-D-00027																											
15. Supplementary Notes		13. Type of Report and Period Covered Final Test Report																											
		14. Sponsoring Agency Code DOT/NHTSA/NRM/OCS																											
16. Abstract A 35 mph (56.3 km/h) frontal barrier impact test was conducted on the subject 2009 Hyundai Sonata 4-Door Sedan at KARCO Engineering, LLC, in Adelanto, CA, on August 22, 2008. This test was conducted to obtain data indicant of FMVSS 208, 212, 219 (partial), 301, and footwell intrusion performance. The impact velocity was 56.36 km/h. The ambient temperature at the barrier at the time of the crash was 34.4 degrees Celsius. The vehicle's maximum post static crush was 355 mm at the vehicle's centerline. The test vehicle was equipped with a 3-point continuous belt system and a second generation airbag at both front outboard positions. With respect to FMVSS 208 'Occupant Crash Protection', the occupant injury criteria summary is as follows:																													
<table border="1" style="width: 100%; border-collapse: collapse;"> <thead> <tr> <th style="width: 30%;">Measurement Description</th> <th style="width: 15%;">Units</th> <th style="width: 15%;">Threshold</th> <th style="width: 15%;">Driver ATD</th> <th style="width: 25%;">Passenger ATD</th> </tr> </thead> <tbody> <tr> <td>Head Injury Criteria (HIC)</td> <td>N/A</td> <td>1000</td> <td style="text-align: center;">281.6</td> <td style="text-align: center;">382.8</td> </tr> <tr> <td>Max. Chest Accel. (3 msec. Chest Clip)</td> <td>G's</td> <td>60</td> <td style="text-align: center;">43.5</td> <td style="text-align: center;">44.9</td> </tr> <tr> <td>Left Femur Force</td> <td>Newtons</td> <td>10008</td> <td style="text-align: center;">-3955.3</td> <td style="text-align: center;">-4280.4</td> </tr> <tr> <td>Right Femur Force</td> <td>Newtons</td> <td>10008</td> <td style="text-align: center;">-3270.5</td> <td style="text-align: center;">-4156.4</td> </tr> </tbody> </table>					Measurement Description	Units	Threshold	Driver ATD	Passenger ATD	Head Injury Criteria (HIC)	N/A	1000	281.6	382.8	Max. Chest Accel. (3 msec. Chest Clip)	G's	60	43.5	44.9	Left Femur Force	Newtons	10008	-3955.3	-4280.4	Right Femur Force	Newtons	10008	-3270.5	-4156.4
Measurement Description	Units	Threshold	Driver ATD	Passenger ATD																									
Head Injury Criteria (HIC)	N/A	1000	281.6	382.8																									
Max. Chest Accel. (3 msec. Chest Clip)	G's	60	43.5	44.9																									
Left Femur Force	Newtons	10008	-3955.3	-4280.4																									
Right Femur Force	Newtons	10008	-3270.5	-4156.4																									
17. Key Words 56.3 km/h NCAP Frontal Impact Test New Car Assesment Program (NCAP) 2009 Hyundai Sonata 4-Door Sedan NHTSA No. M90502			18. Distribution Statement Copies of this report are available from: National Highway Traffic Safety Admin. NHTSA Technical Reference Division 1200 New Jersey Ave., SE, Room W43-410 Washington, DC 20590																										
19. Security Classification of this report UNCLASSIFIED	20. Security Classification of this page UNCLASSIFIED	21. No. of Pages 129	22. Price																										

Form DOT F1700.7 (8-72)

TR-P28001-22-NC

TABLE OF CONTENTS

Section	Description	Page
1	Purpose and Summary of Test M90502	1
2	Occupant and Vehicle Information/Data Sheets	3

Data Sheet	Description	Page
1	Crash Test Summary	4
2	General Test and Vehicle Parameter Data	5
3	Post-Test Impact Data	8
4	Test Vehicle Information	9
5	Dummy Positioning in Vehicle	11
6	Seat Belt Positioning Data	13
7	Vehicle Accelerometer Location	14
8	Seat Belt Assessment Test Data	15
9	Summary of FMVSS 212 Data	16
10	Windshield Zone Intrusion FMVSS 219 Data (Partial)	17
11	FMVSS 301 Fuel System Integrity Post-Impact Data	18
12	FMVSS 301 Static Rollover Data	19
13	Vehicle Measurements	21
14	Camera Locations	24
15	Photographic Reference Target Locations	25
16	Vehicle Intrusion Measurements	26
17	Fixed Barrier Load Cell Locations	31
18	Accident Investigation Division Data	32
19	Dummy/Vehicle Temperature Stabilization	33

Appendix	Description	Appendix
A	Photographs	A
B	Data Plots	B
C	Dummy Calibration Data	C

SECTION 1
PURPOSE AND SUMMARY OF TEST M90502

1.1 PURPOSE

This 35 mph (56.3 km/h) frontal barrier impact test is part of the New Car Assessment Program (NCAP) sponsored by the National Highway Traffic Safety Administration (NHTSA) under Contract No. DTNH22-06-D-00027. The purpose of this test was to obtain vehicle crashworthiness and occupant restraint system performance data for an impact speed in excess of the current 30 mph (48.3 km/h) requirements.

The 35 mph (56.3 km/h) frontal barrier impact test was conducted in accordance with the Office of Crashworthiness Standards (OCS) New Car Assessment Program (NCAP) Laboratory Indicant Test Procedure, dated July 2005. Data was obtained indicant of FMVSS 208 "Occupant Crash Protection", FMVSS 212, "Windshield Retention", FMVSS 219, "Windshield Zone Intrusion (Partial)", and FMVSS 301 "Fuel System Integrity", performance. Procedures for receiving, inspection, testing and reporting of test results are described in the test procedures and are not repeated in this report.

1.2 SUMMARY

A load cell barrier consisting of 36 load cells was impacted by a 2009 Hyundai Sonata 4-Door Sedan at a velocity of 56.36 km/h. The test was performed at KARCO Engineering, LLC on August 22, 2008

Three (3) real-time and fourteen (14) high-speed cameras were used to document the frontal barrier impact event. Camera locations and other pertinent camera information can be found in Data Sheet number 14 (page number 24) of this report.

Two Part 572E, 50th percentile male anthropomorphic test devices (ATDs), were placed in the driver and right-front passenger seating positions according to dummy placement instructions specified in the Laboratory Indicant Test Procedure.

Both ATDs were fully instrumented with head (primary and redundant), chest (primary and redundant) and pelvis triaxial accelerometers, chest displacement potentiometers, six-axis upper neck transducers, right/left femur load cells, and lower leg instrumentation. Seat belt load cells were placed on the driver's and passenger's lap and shoulder belts to measure dummy torso and pelvic section loading. Shoulder belt spool-off was measured for the driver and passenger dummies. The driver (position 1) ATD (Serial No.034) and the right-front passenger (position 2) ATD (Serial No. 035) were calibrated one test prior to this test.

One hundred and thirty-two (132) channels of data were recorded using a TDAS data acquisition system. Appendix A contains Pre and Post-Test Photographs, Appendix B contains the Dummy Response data traces, and Appendix C contains the Dummy Calibration data.

There was 100% windshield retention and no intrusion into the protected zone of the windshield during impact. There was no Stoddard solvent leakage after the event, or during any phase of the static rollover.

The maximum static crush of the vehicle was 355 mm at the vehicle's centerline. Both the driver and passenger side doors remained closed and latched during the impact event, and were operable after the impact.

The driver's visible contact points were as follows: The driver ATD's head, chest, and abdomen contacted the airbag. The head also contacted the headrest. Both knees contacted the bolster.

The passenger's visible contact points were as follows: The passenger ATD's head, chest, and abdomen contacted the airbag. The head also contacted the headrest. Both knees contacted the glovebox.

Occupant injury data is contained in table below.

OCCUPANT DATA SUMMARY

ATD Position	HIC 36	3 msec Chest Clip	Chest Defl. (mm)	Left Femur (N)	Right Femur (N)
Driver	281.6	43.5	-36.2	-3955.3	-3270.5
Passenger	382.8	44.9	-30.2	-4280.4	-4156.4

Additional data plots for this test are available in the research and development section of the NHTSA website. The website can be found at: www.NHTSA.Dot.Gov

SECTION 2

OCCUPANT AND VEHICLE INFORMATION/DATA SHEETS

Test Vehicle: 2009 Hyundai Sonata 4-Door Sedan NHTSA No.: M90502
Test Program: NHTSA 35mph NCAP Test Date: 8/22/08

CONVERSION FACTORS USED IN THIS REPORT*

Quantity	Typical Application	Std Units	Metric Unit	Multiply By
Mass	Vehicle Weight	lb	kg	0.4536
Linear Velocity	Impact Velocity	miles/hr	km/hr	1.609344
Length or Distance	Measurements	in	mm	25.4
Volume	Fuel Systems	gal	liter	3.785
Volume	Small Fluids	oz	mL	29.573
Pressure	Tire Pressures	lbf/in ²	kPa	7.0
Volume	Liquid	gal	liter	3.785
Temperature	General Use	°F	°C	$=(tf - 32)/1.8$
Force	Dynamic Forces	lbf	N	4.448
Moment	Torque	lbf/ft	Nm	1.355

* Based on the Recommended Practice in SAE J916, May 85

DATA SHEET NO. 1
CRASH TEST SUMMARY

Test Vehicle: 2009 Hyundai Sonata 4-Door Sedan
 Test Program: NHTSA 35mph NCAP

NHTSA No.: M90502
 Test Date: 8/22/08

PRIMARY IMPACT DATA

Measured Parameter	Units	Value
Velocity at Impact	km/h	56.36
Test Weight	kg	1708
Impact Angle	degrees	0
Average Rebound	mm	818
Maximum Static Crush	mm	355

DOOR OPENING AND SEAT TRACK INFORMATION

Description	Driver	Passenger
Front Door Opening	Remained closed and latched, jammed	Remained closed and latched, jammed
Rear Door Opening	Remained closed and latched, opened without tools	Remained closed and latched, opened without tools
Seat Track Shift (mm)	None	None
Seatback Failure	No	No

TEST DUMMY INFORMATION

Description	Driver	Passenger
Dummy Type/Serial No.	50% Male Hybrid III No.034	50% Male Hybrid III No. 035
Head Contact	Airbag, Headrest	Airbag, Headrest
Chest Contact	Airbag	Airbag
Abdomen Contact	Airbag	Airbag
Left Knee Contact	Bolster	Glovebox
Right Knee Contact	Bolster	Glovebox

MOVIE COVERAGE

Cameras	Standard	Additional
High Speed	16	0
Real Time	1	2
Total	15	2

DATA CHANNELS

Driver ATD Sensors	40
Passenger ATD Sensors	40
Belt Assessment Sensors	8
Vehicle Structure Acclerometers	8
Rigid Barrier Load Cells	36
Total	132

DATA SHEET NO. 2

GENERAL TEST AND VEHICLE PARAMETER DATA

Test Vehicle: 2009 Hyundai Sonata 4-Door Sedan NHTSA No.: M90502
 Test Program: NHTSA 35mph NCAP Test Date: 8/22/08

TEST VEHICLE INFORMATION AND OPTIONS

NHTSA No.	M90502
Make	Hyundai
Model	Sonata
Body Style	4-Door Sedan
VIN No.	5NPET46C09H402560
Color	Khaki
Delivery Date	08/07/08
Odometer (Miles)	81.0
Dealer	Future Hyundai
Transmission	5-Speed Automatic
Final Drive	Front
Type/No. of Cylinders	4
Engine Displ. (L)	2.4
Engine Placement	Transverse
Roof Rack	No
Sunroof/T-top	No
Tinted Glass	No
Traction Control	Yes
Power Brakes	Yes
Front Disc	Yes
Rear Disc	Yes

Anti-Lock Brakes	Yes
All Wheel Drive	No
Power Steering	Yes
Driver Front Airbag	Yes
Driver Side Torso Airbag	Yes
Driver Side Head Airbag	No
Driver Curtain Airbag	Yes
Pass. Front Airbag	Yes
Pass. Side Torso Airbag	Yes
Pass. Head Airbag	No
Pass. Curtain Airbag	Yes
Pre-Tensioners	Yes
Load Limiters	Yes
Bucket Seats	Yes
Air Conditioning	Yes
AM/FM CD	Yes
Tilt Steering	Yes
Automatic Door Locks	Yes
Power Windows	Yes
Power Seats	No
Other	n/a

Does the Owner's Manual provide instructions to turn off automatic door locks? No

DATA FROM MANUFACTURER'S LABEL

Manufactured By	HYUNDAI MOTOR MANUFACTURING ALABAMA,LLC
Date of Manufacture	Jan-08

GVWR (kg)	1950
GAWR Front (kg)	1140
GAWR Rear (kg)	970

VEHICLE SEATING CAPACITY AND WEIGHT INFORMATION

Measured Parameter	Front	Rear	Third	Total
Type of Seats	Bucket	Bench		
Number of Occupants	2	3		5
Capacity Weight (VCW) (kg)				390
Cargo Weight (RCLW) (kg)				50

DATA SHEET NO. 2...(CONTINUED)

GENERAL TEST AND VEHICLE PARAMETER DATA

Test Vehicle: 2009 Hyundai Sonata 4-Door Sedan

NHTSA No.: M90502

Test Program: NHTSA 35mph NCAP

Test Date: 8/22/08

Collect year, make, model, VIN, items circled in red, and tire manufacturer and tire name.

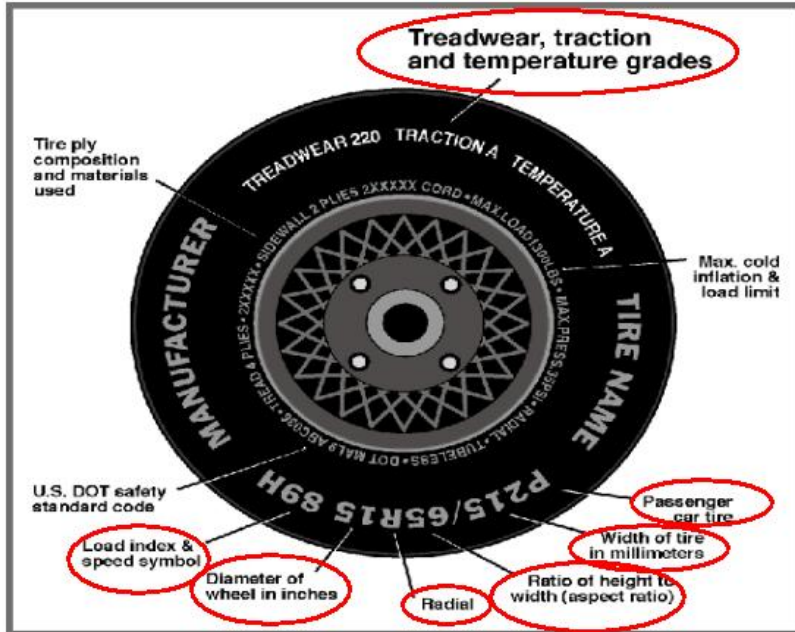

TIRE INFORMATION

Measured Parameter	Front	Rear
Max. Tire Pressure (kPa)	308	308
Cold Tire Pressure (kPa)	220	220
Recommended Tire Size	P215/60R16	P215/60R16
Tire Size on Vehicle	P215/60R16	P215/60R16
Tire Manufacturer	Michelin	Michelin
Treadwear	300	300
Traction	A	A
Temperature Grades	A	A
Tire Plies - Sidewall	2 Polyester	2 Polyester
Tire Plies - Body	2 Polyester, 1Polyamide, 2 Steel	2 Polyester, 1Polyamide, 2 Steel
Load Index/Speed Symbol	97V	97V
Tire Material	Polyester, Polyamide, Steel	Polyester, Polyamide, Steel
DOT Safety Code Right	B9NP 1J9X 2108	B9NP 1J9X 2108
DOT Safety Code Left	B9NP 1J9X 2108	B9NP 1J9X 2108

DATA SHEET NO. 2...(CONTINUED)

GENERAL TEST AND VEHICLE PARAMETER DATA

Test Vehicle: 2009 Hyundai Sonata 4-Door Sedan NHTSA No.: M90502
 Test Program: NHTSA 35mph NCAP Test Date: 8/22/08

TEST VEHICLE WEIGHTS

	Units	As Delivered Weights (UVW)			As Tested Weights (ATW)		
		Front Axle	Rear Axle	Total	Front Axle	Rear Axle	Total
Left	kg	456	302	758	494	365	859
Right	kg	458	295	753	492	357	849
Ratio	%	60.5	39.5	100.0	57.7	42.3	100.0
Totals	kg	914	597	1511	986	722	1708

TARGET TEST WEIGHT CALCULATION

Measured Parameter	Units	Value
Total Delivered Weight (UVW)	kg	1511
Weight of 2 P572 ATD's	kg	152
Rated Cargo/Luggage Weight (RCLW)	kg	50
Calculated Target Vehicle Test Weight (TVT _W)	kg	1713

TEST VEHICLE ATTITUDE AND CG

	Units	LF	RF	LR	RR	CG Aft of Front Axle
As Delivered	mm	708	716	710	715	1077
As Tested	mm	694	696	674	680	1154

Vehicle Wheel Base (mm) 2727
 Weight of Ballast Secured in Cargo Area (kg) 0
 Weight of Items Removed (kg) 58
 Vehicle Components Removed: Trunk lid, spare tire and tools, trunk carpeting, rear bumper cover,

*Ballast weight does not include cameras, instrumentation or brake abort system.

FUEL SYSTEM DATA

Fuel System Capacity from Owner's Manual (L) 66.99
 Actual Test Volume with Entire Fuel System Filled (L) 62.30
 Test Fluid Type Stoddard Solvent
 Kinematic Viscosity as per ASTM Standard D484-71 Red
 Is Vehicle Fuel Pump Electric or Mechanical? electric
 If electric, does pump operate with the ignition switch "ON" & engine "OFF"? yes
 Fuel System Particulars The electric fuel pump operates for 2 seconds to pressurize the fuel system following the activation of the ignition. The fuel pump operates continuously while the engine is running.

DATA SHEET NO. 3
POST-TEST IMPACT DATA

Test Vehicle: 2009 Hyundai Sonata 4-Door Sedan
 Test Program: NHTSA 35mph NCAP

NHTSA No.: M90502
 Test Date: 8/22/08

SPEED TRAP DATA

Measured Paramater	Units	Requirement	Value
Trap No. 1 Velocity	km/h	55.1 to 57.12	56.36
Trap No. 2 Velocity	km/h	55.1 to 57.12	Failed

VEHICLE STATIC CRUSH

Measured Parameter	Units	Pre-Test	Post-Test	Difference
Left Side	mm	4595	4330	265
Center	mm	4805	4450	355
Right Side	mm	4595	4345	250

VEHICLE REBOUND FROM BARRIER

Measured Paramater	Units	Value
Left Side	mm	805
Center	mm	760
Right Side	mm	890
Average	mm	818

DATA SHEET NO. 4

TEST VEHICLE INFORMATION

Test Vehicle: 2009 Hyundai Sonata 4-Door Sedan

NHTSA No.: M90502

Test Program: NHTSA 35mph NCAP

Test Date: 8/22/08

NOMINAL DESIGN RIDING POSITION

The driver and passenger seat backs are positioned to the manufacturer's designated angle. The procedure is as follows: Seat back angle was measured at the headrest, using a digital inclinometer.

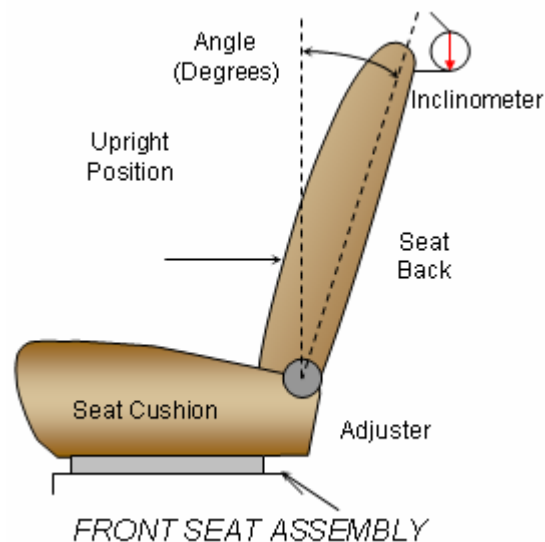

SEAT BACK ANGLES

Position	Degrees
Driver w/ Seated Dummy	10.8 @ headrest
Passenger w/ Seated Dummy	10.8 @ headrest

SEAT FORE/AFT POSITIONS

The total seat travel was measured from forward most position to rearmost position. The seat was set at the longitudinal mid position. There were vertical adjustments on the driver seat that was equipped with the vehicle. There were no adjustments on the passenger seat. The driver seat was placed in the lowermost position.

SEAT FORE/AFT POSITIONING

Position	Total Fore/Aft Travel	Placed in Position
Driver Seat	25 Detents	13th Detent
Passenger Seat	25 Detents	13th Detent

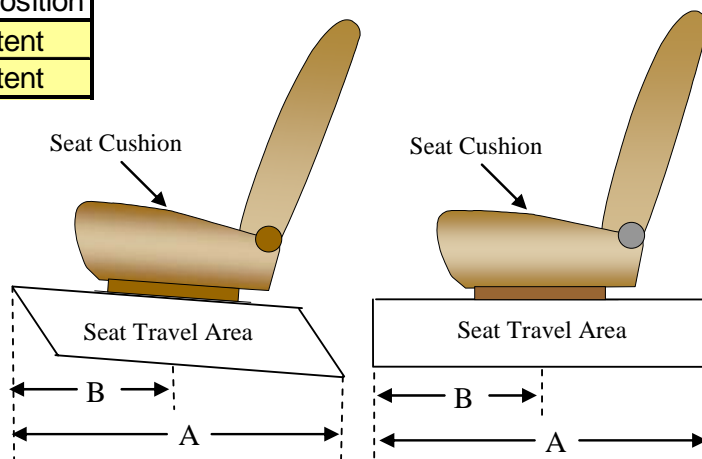

SEAT BELT ANCHORAGE

Position number one (1) is the uppermost position.

SEAT BELT ANCHORAGE POSITIONING

	Total Number of Positions	Placed in Position
Driver Seat	4	2
Passenger Seat	4	2

DATA SHEET NO. 4...(CONTINUED)

TEST VEHICLE INFORMATION

Test Vehicle: 2009 Hyundai Sonata 4-Door Sedan

NHTSA No.: M90502

Test Program: NHTSA 35mph NCAP

Test Date: 8/22/08

FUEL TANK CAPACITY

	Liters
Usable Capacity of Standard Tank	66.99
Usable Capacity of Optional Tank	
Usable Capacity Used for FMVSS 301	61.62 to 62.98
Actual Amount of Solvent Used	62.30

The test vehicle is equipped with an electric fuel pump. The fuel pump will operate for approximately two (2) seconds with the ignition in the "ON" position, after which the fuel pump automatically shuts off. The fuel filler door is located on the left rear fender. The standard fuel tank occupies the area under rear seat.

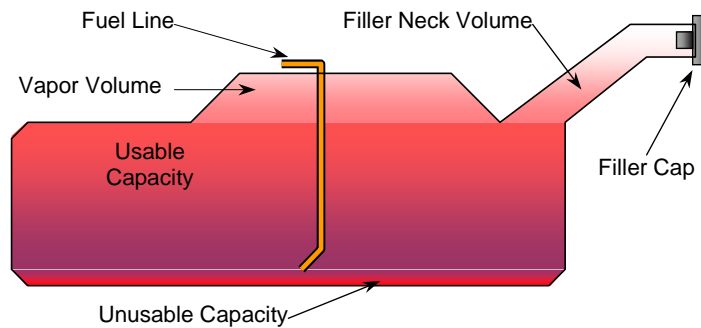

VEHICLE FUEL TANK ASSEMBLY

STEERING COLUMN ADJUSTMENT

Steering wheel and column adjustments are made so that the steering wheel hub is at the geometric center of the locus it describes when moved through its full range of motion. An aluminum plate is placed across the rim of the steering wheel, an inclinometer is placed on the plate and the angle is measured.

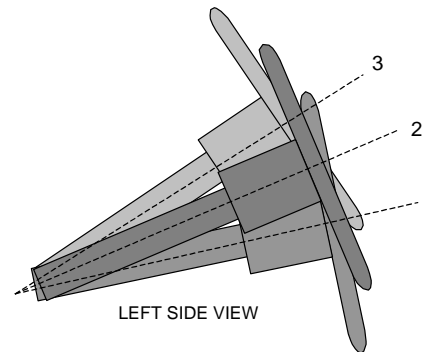

STEERING COLUMN ASSEMBLY

STEERING COLUMN POSITIONS

	Degrees	Fore/Aft Position
Lowermost - Position No. 1	32.9	
Geometric Center - Position No. 2	25.9	
Uppermost - Position No. 3	18.9	

DATA SHEET NO. 5

DUMMY POSITIONING IN VEHICLE

Test Vehicle: 2009 Hyundai Sonata 4-Door Sedan

NHTSA No.: M90502

Test Program: NHTSA 35mph NCAP

Test Date: 8/22/08

TEST DUMMY POSITION MEASUREMENTS

Code	Measurement Description	Driver		Passenger	
		Length (mm)	Angle (°)	Length (mm)	Angle (°)
WA	Windshield angle		26.1		
SWA	Steering wheel angle		65.7		
SCA	Steering column angle		24.3		
SA	Seat Back angle		10.6 @ headrest		10.8 @ headrest
HZ	Head to roof (Z)	209	90.0	203	90.0
HH	Head to header	326		326	
HW	Head to windshield	597		578	
HR	Head to side header (Y)	300		295	
NR	Nost to rim	387	10.1		
CD	Chest to dash	545		579	
CS	Chest to steering hub	271			
RA	Rim to abdomen	180			
KDL	Left knee to dash	149	35.9	119	
KDR	Right knee to dash	125		159	34.7
PA	Pelvic angle		24.4		23.3
TA	Tibia Angle		43.3		44.0
KK	Knee to knee	315		287	
SK	Striker to outboard knee	652	17.0	641	6.4
ST	Striker to head	420	79.9	405	80.4
SH	Striker to H-Point	225	0.0	240	0.0
SHY	Striker to H-Point (Y)	235		243	
HS	Head to side window	345		359	
HD	H-Point to door	170		168	
AD	Arm to door	138		50	

DATA SHEET NO. 5...(CONTINUED)

DUMMY POSITIONING IN VEHICLE

Test Vehicle: 2009 Hyundai Sonata 4-Door Sedan

NHTSA No.: M90502

Test Program: NHTSA 35mph NCAP

Test Date: 8/22/08

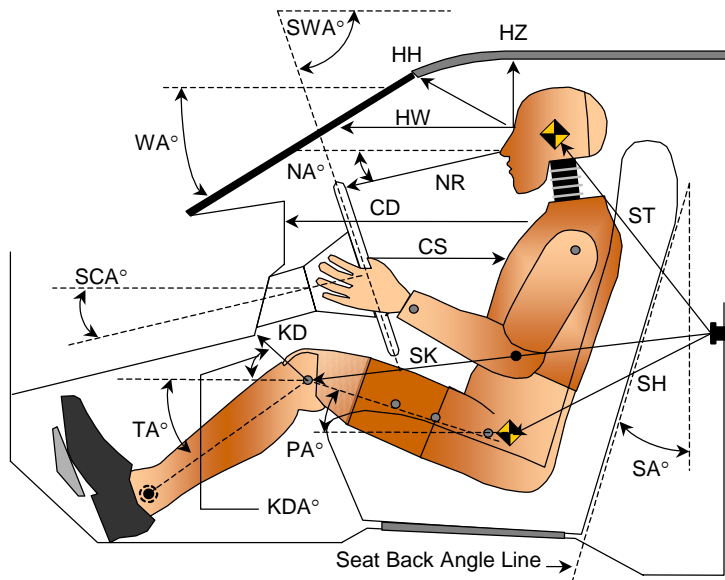

- | | |
|-----|-----------------------------|
| AD | Arm to Door |
| HD | H-Point to Door |
| HR | Head to Side Header |
| HS | Head to Side Window |
| KK | Knee to Knee |
| SHY | Striker to H-Point (Y Axis) |

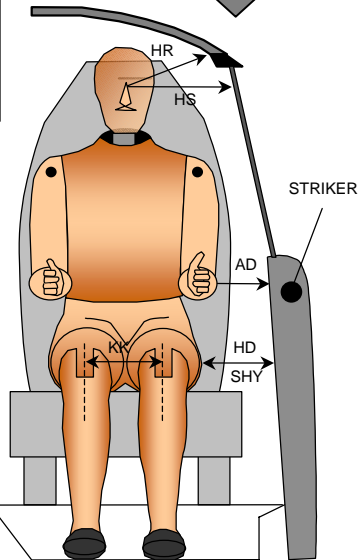

- | | |
|-----|-----------------------------|
| CD | Chest to Dash |
| CS | Chest to Steering Wheel Hub |
| HH | Head to Header |
| HW | Head to Windshield |
| HZ | Head to Roof |
| KDA | Knee to Dash Angle |
| KDL | Left Knee to Dash |
| KDR | Right Knee to Dash |
| NA | Nose to Rim Angle |
| NR | Nose to Rim |
| PA | Pelvic Angle |
| RA | Rim to Abdomen |
| SA | Seat Back Angle |
| SCA | Steering Column Angle |
| SH | Striker to H-Point |
| SK | Striker to Knee |
| ST | Striker to Head |
| SWA | Steering Wheel Angle |
| TA | Tibial Angle |
| WA | Windshield Angle |

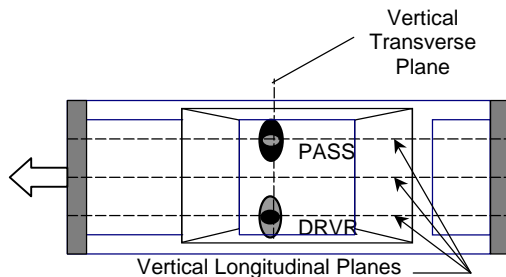

DATA SHEET NO. 6

SEAT BELT POSITIONING DATA

Test Vehicle: 2009 Hyundai Sonata 4-Door Sedan

NHTSA No.: M90502

Test Program: NHTSA 35mph NCAP

Test Date: 8/22/08

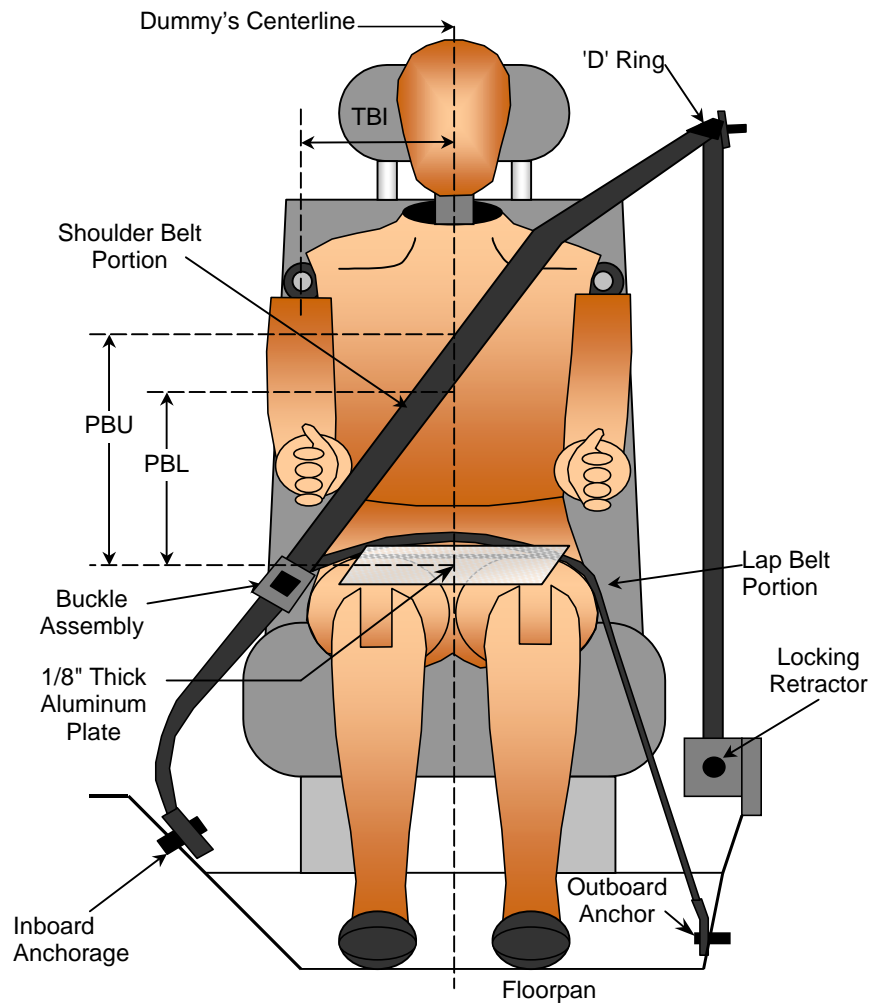

SEAT BELT POSITIONING MEASUREMENTS

Measured Parameter	Units	Driver	Passenger
TBI - Dummy C/L to Lap/Shoulder Belt Intersect	mm	205	240
PBU - Top Surface of Reference to Belt Upper Edge	mm	330	340
PBL - Top Surface of Reference to Belt Lower Edge	mm	260	265
Lap Belt Tension	Newtons	10	10
Shoulder Belt Tension	N/A	Retractor	Retractor

DATA SHEET NO. 7**VEHICLE ACCELEROMETER LOCATIONS**Test Vehicle: 2009 Hyundai Sonata 4-Door SedanNHTSA No.: M90502Test Program: NHTSA 35mph NCAPTest Date: 8/22/08**VEHICLE ACCELEROMETER PRE-TEST LOCATIONS**

No.	Accelerometer Location	Measurement (mm)		
		X	Y	Z
1	Left Rear X-Member	1843	-709	330
2	Right Rear X-Member	1843	709	330
3	Engine Top	3980	20	833
4	Engine Bottom	3985	300	141
5	Left Brake Caliper	3614	-692	346
6	Right Brake Caliper	3614	692	346
7	Instrument Panel			
8	Left Rear X-Member (Z-Axis)	1843	-709	330
9	Right Rear X-Member (Z-Axis)	1843	709	330

Reference Planes: X=From Rear Surface of Vehicle, Y=Vehicle Centerline, Z=Ground Plane

- 1.) Instrument Panel no longer used by NHTSA.
- 2.) Instrumentation not installed

DATA SHEET NO. 8**SEAT BELT ASSESSMENT TEST DATA**

Test Vehicle: 2009 Hyundai Sonata 4-Door Sedan NHTSA No.: M90502
 Test Program: NHTSA 35mph NCAP Test Date: 8/22/08

SEAT BELT POSITIONING MEASUREMENTS

Measurement Description	Units	Driver	Passenger
Retractor Reel to D-Ring	mm	705	705
Shoulder Belt Length as Measured on ATD	mm	855	861
Lap Belt Length as Measured on ATD	mm	846	874
Remainder of Belt on Reel	mm	781	748
Total Belt Length for Continuous Webbing Systems	mm	3187	3188

SHOULDER BELT SPOOL-OFF DATA

Measurement Description	Units	Driver	Passenger
As determined mechanically	mm	N/A	N/A
As determined electronically	mm	0	0

BELT STRETCH DATA

Measurement Description	Units	Driver	Passenger
Electronically between belt load cell and D-Ring	mm/cm	*	*
Mechanically	mm/cm		

*Not used with shoulder belt pre-tensioner systems

DATA SHEET NO. 9

SUMMARY OF FMVSS 212 DATA

Test Vehicle: 2009 Hyundai Sonata 4-Door Sedan NHTSA No.: M90502
 Test Program: NHTSA 35mph NCAP Test Date: 8/22/08

Windshield Mounting Details: Windshield glass is secured to the vehicle frame with rubber cement type adhesive. Plastic and rubber molding covers the windshield periphery.

The standard requires that the post-test retention measurement be a minimum of 75 percent of the pretest total periphery measurement for vehicles not equipped with occupant passive restraints and 50 percent for each side of the windshield for vehicles that are equipped with occupant passive restraints.

Temperature of windshield molding during test: 34.3 °C

WINDSHIELD PERIPHERY MEASUREMENTS

Measurement	Pre-Test (mm)	Post-Test (mm)	% of Retention
Left Side	2185	2185	100.0
Right Side	2185	2185	100.0
Total	4370	4370	100.0

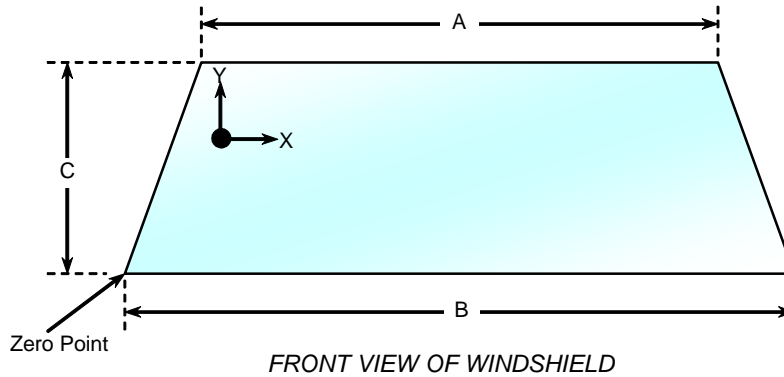

WINDSHIELD DIMENSIONS

Item	Units	Segment Length	Molding Width
A	mm	1180	5
B	mm	1520	0
C-Left	mm	835	20
C-Right	mm	835	20

DATA SHEET NO. 10

WINDSHIELD ZONE INTRUSION FMVSS 219 DATA (PARTIAL)

Test Vehicle: 2009 Hyundai Sonata 4-Door Sedan
 Test Program: NHTSA 35mph NCAP

NHTSA No.: M90502
 Test Date: 8/22/08

WINDSHIELD AND PROTECTED ZONE

Item	Units	Value
A	mm	1180
B	mm	390
C	mm	1520
D	mm	835
E	mm	500
F	mm	505

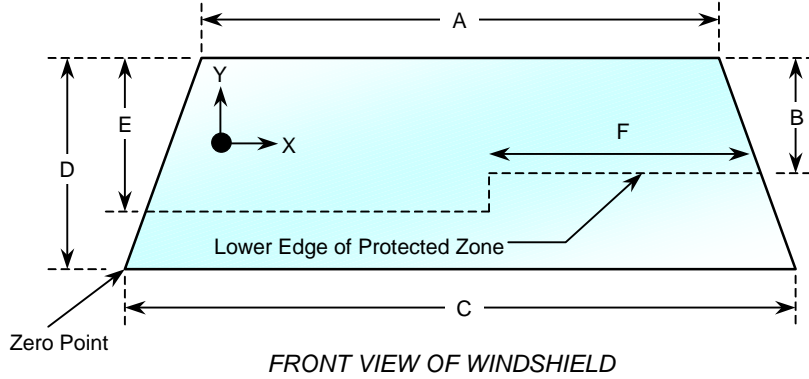

AREA OF PROTECTED ZONE FAILURES

A. Provide coordinates of the area that the protected zone was penetrated more than 0.25 in. by a vehicle component other than one that is normally in contact with the windshield.

X	Y

B. Provide coordinates of the area beneath the protected zone that the inner surface of the windshield was penetrated by a vehicle component.

X	Y

DATA SHEET NO. 11

FMVSS 301 FUEL SYSTEM INTEGRITY POST-IMPACT DATA

Test Vehicle: 2009 Hyundai Sonata 4-Door Sedan NHTSA No.: M90502
Test Program: NHTSA 35mph NCAP Test Date: 8/22/08

Test Time: 1:30 PM Temperature: 34.4 ° C

STODDARD SOLVENT SPILLAGE MEASUREMENTS

- A. From impact until vehicle motion ceases: 0
(Maximum allowable = 1 ounce)
- B. For the 5 minute period after motion ceases: 0
(Maximum allowable = 5 ounces)
- C. For the following 25 minutes: 0
(Maximum allowable = 1 oz/minute)
- D. Spillage Details: No leakage occurred

DATA SHEET NO. 12

FMVSS 301 STATIC ROLLOVER DATA

Test Vehicle: 2009 Hyundai Sonata 4-Door Sedan

NHTSA No.: M90502

Test Program: NHTSA 35mph NCAP

Test Date: 8/22/08

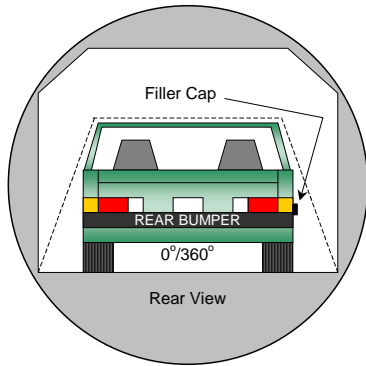

0° to 90°

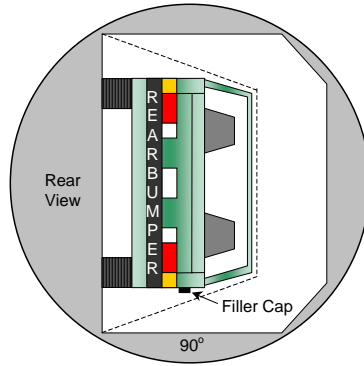

90° to 180°

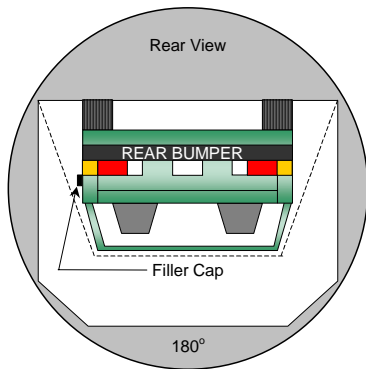
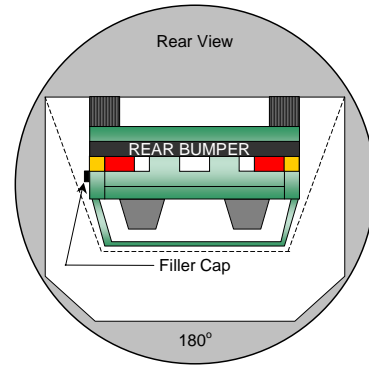

180° to 270°

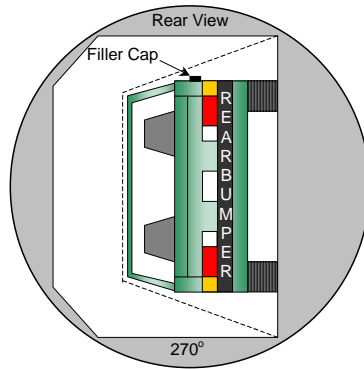

270° to 360°

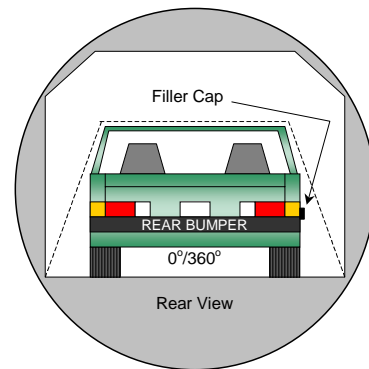

1. The specified fixture rollover rate for each 90° of rotation is 60 to 120 seconds.
2. The position hold time at each position is 300 seconds (minimum).
3. No solvent leakage occurred during rollover.

DATA SHEET NO. 12...(CONTINUED)
FMVSS 301 STATIC ROLLOVER DATA

Test Vehicle: 2009 Hyundai Sonata 4-Door Sedan NHTSA No.: M90502
 Test Program: NHTSA 35mph NCAP Test Date: 8/22/08

SOLVENT COLLECTION TIME TABLE IN SECONDS

Test Phase	Rotation Time	Hold Time	Total Time
0° to 90°	83	305	388
90° to 180°	83	315	398
180° to 270°	77	319	396
270° to 360°	76	300	376

FMVSS 301 SPILLAGE TABLE REQUIREMENT

First 5 Minutes	5.0
Sixth Minute	1.0
Seventh Minute	1.0
Eighth Minute	1.0

ACTUAL TEST VEHICLE SOLVENT SPILLAGE TABLE (OZ)

Test Phase	First 5 Minutes	Sixth Minute	Seventh Minute	Eighth Minute
0° to 90°	0	0	0	0
90° to 180°	0	0	0	0
180° to 270°	0	0	0	0
270° to 360°	0	0	0	0

SOLVENT SPILLAGE LOCATION TABLE

Test Phase	Spillage Location
0° to 90°	None
90° to 180°	None
180° to 270°	None
270° to 360°	None

DATA SHEET NO. 13
VEHICLE MEASUREMENTS

Test Vehicle: 2009 Hyundai Sonata 4-Door Sedan

NHTSA No.: M90502

Test Program: NHTSA 35mph NCAP

Test Date: 8/22/08

VEHICLE MEASUREMENT TABLE

No.	Measurement Description	Units	Pre-Test	Post-Test	Difference
1	Length of test vehicle at centerline	mm	4805	4450	-355
2	RSOV to front of engine	mm	4288	4095	-193
3	RSOV to firewall centerline	mm	3710	3705	-5
4	RSOV to upper leading edge of right door	mm	3340	3350	10
5	RSOV to upper leading edge of left door	mm	3340	3346	6
6	RSOV to lower leading edge of right door	mm	3298	3290	-8
7	RSOV to lower leading edge of left door	mm	3297	3294	-3
8	RSOV to upper trailing edge of right door	mm	2257	2260	3
9	RSOV to upper trailing edge of left door	mm	2254	2260	6
10	RSOV to lower trailing edge of right door	mm	2253	2240	-13
11	RSOV to lower trailing edge of left door	mm	2251	2245	-6
12	RSOV to bottom of right A-pillar	mm	3296	3298	2
13	RSOV to bottom of left A-pillar	mm	3291	3298	7
14	RSOV to firewall on right side	mm	3695	3685	-10
15	RSOV to firewall on left side	mm	3695	3610	-85
16	RSOV to steering column hub	mm	2863	2820	-43
17	Center of steering column to left A-pillar, Y	mm	425	385	-40
18	Center of steering column to headlining, Z	mm	430	390	-40
19	RSOV to right side of front bumper	mm	4595	4345	-250
20	RSOV to left side of front bumper	mm	4595	4330	-265
21	Length of engine block	mm	585	585	0
RD	RSOV to right side of dash panel	mm	3100	3110	10
CD	RSOV to center of dash panel	mm	3085	3085	0
LD	RSOV to left side of dash panel	mm	3100	3075	-25

DATA SHEET NO. 13...(CONTINUED)

VEHICLE STRUCTURAL MEASUREMENTS

Test Vehicle: 2009 Hyundai Sonata 4-Door Sedan

NHTSA No.: M90502

Test Program: NHTSA 35mph NCAP

Test Date: 8/22/08

VEHICLE STRUCTURAL MEASUREMENT TABLE

No.	Measurement Description	Units	Pre-Test	Post-Test	Difference
1	Total length	mm	4805	4450	-355
2	Total width	mm	1810	1805	-5
3	Front bumper top height	mm	585	540	-45
4	Front bumper bottom height	mm	219	178	-41
5	Longitudinal member top height	mm	515	535	20
6	Longitudinal member bottom height	mm	385	410	25
7	Distance between longitudinal members	mm	925	940	15
8	Longitudinal member width	mm	80	100	20
9	Engine top height	mm	850	860	10
10	Engine bottom height	mm	336	358	22
11	Engine and gearbox width	mm	590	590	0
12	Front bumper-engine distance	mm	515	365	-150
13	Front shock absorber height	mm	860	860	0
14	Front hood leading edge height	mm	705	725	20
15	Distance between front shock absorbers	mm	1035	960	-75
16	Front bumper-front axle distance	mm	955	665	-290
17	Front axle to A-pillar distance	mm	490	440	-50
18	A Pillar to B Pillar distance	mm	981	978	-3
19	B Pillar to rear axle distance	mm	1151	1145	-6
20	B Pillar to C Pillar distance	mm	958	956	-2
21	Roof sill bottom height	mm	1340	1310	-30
22	Roof sill top height	mm	1445	1415	-30
23	Floor sill bottom height	mm	224	183	-41
24	Floor sill top height	mm	355	320	-35

DATA SHEET NO. 13...(CONTINUED)

VEHICLE MEASUREMENTS

Test Vehicle: 2009 Hyundai Sonata 4-Door Sedan

NHTSA No.: M90502

Test Program: NHTSA 35mph NCAP

Test Date: 8/22/08

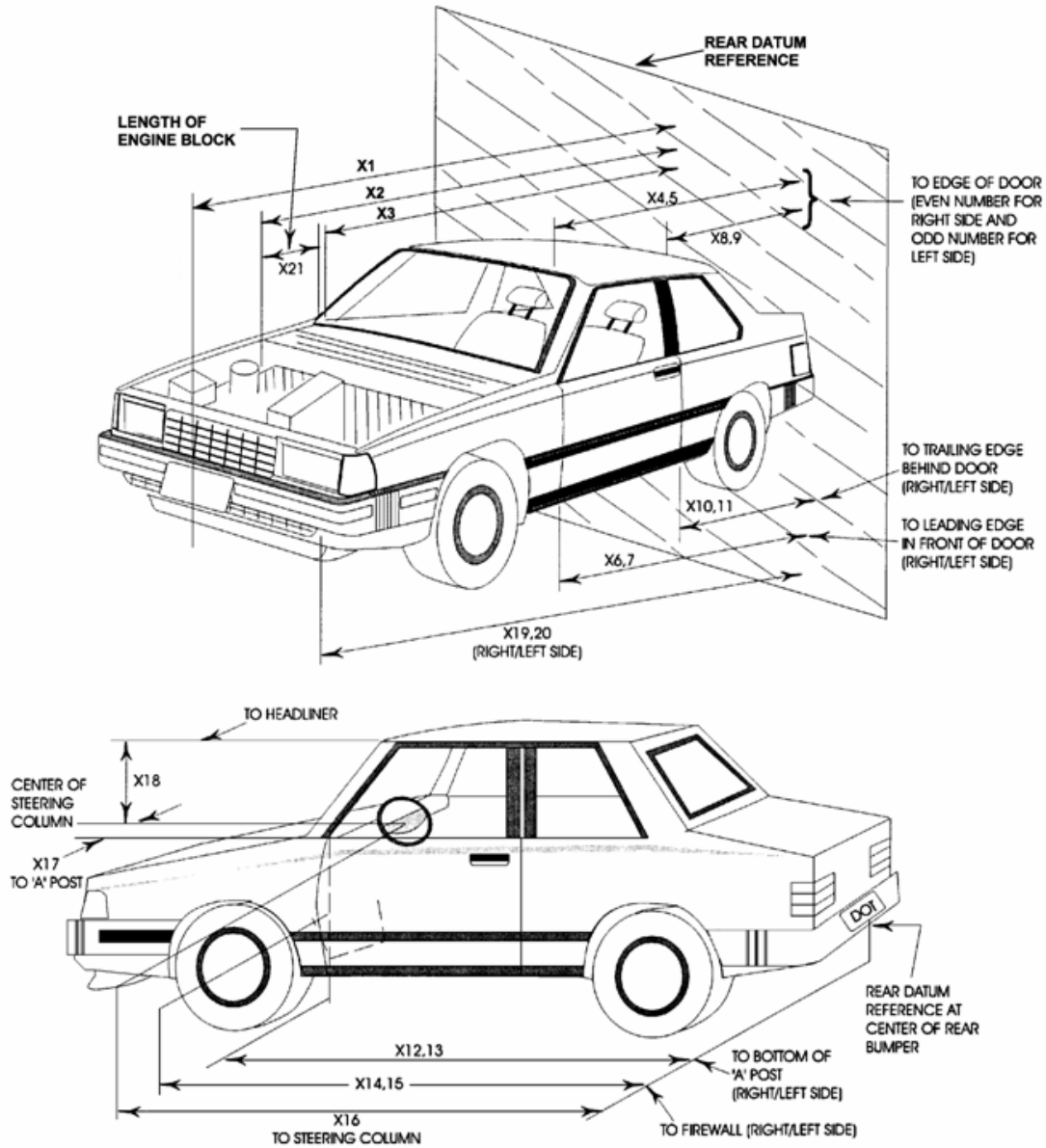

DATA SHEET NO. 14
CAMERA LOCATIONS

Test Vehicle: 2009 Hyundai Sonata 4-Door Sedan

NHTSA No.: M90502

Test Program: NHTSA 35mph NCAP

Test Date: 8/22/08

VEHICLE CAMERA MEASUREMENT TABLE

No.	Camera View	Location			Angle (deg)	Film Plane to Head	Lens (mm)	Speed (fps)
		X	Y	Z				
1	Real Time Camera (Panning)	-11412	-8150	-1484	0			30
2	Overall Left Side	-2626	-6949	-1199	0	8105	20	1000
3	Closeup Left Side	-1706	-5751	-1292	0	7844	50	1000
4	Driver and Interior View	-6696	-5987	-1071	-17	15570	ZOOM	1000
5	Steering Column (Bottom)	-1972	-8184	-2879	-13	9453	35	1000
6	Steering Column (Top)	-1966	-8141	-3258	-13	9549	35	1000
7	Overall Right Side	-2400	6690	-1049	0	7409	20	1000
8	Closeup Right Side	-1750	5725	-1359	0	7079	50	1000
9	Passenger and Interior View	-5136	9516	-2460	-10	10211	ZOOM	1000
10	Right Side View	-1582	7995	-1713	-6	7134	ZOOM	1000
11	Windshield View	-354	0	-5749	-90		24	1000
12	Driver Front View	363	-543	-2548	-34		25	1000
13	Passenger Front View	381	445	-2548	-34		25	1000
14	Pit View of Engine	-756	0	1495	90		12	1000
15	Pit View of Fuel Tank	-3398	0	1495	90		8	1000
16	Driver Side Dummy On-Board	-2426	0	-1397	90	787	12	1000
17	Passenger Side Dummy On-Board	-2972	-508	-1397	-7	1143	12	1000
18	Real Time Driver	-1926	-8089	-1704	-1	-1704	-1	30
19	Real Time Passenger	-1433	8047	-1704	-1	-1704	-1	30

All measurements are made relative to the point of impact.

DATA SHEET NO. 15

PHOTOGRAPHIC REFERENCE TARGET LOCATIONS

Test Vehicle: 2009 Hyundai Sonata 4-Door Sedan

NHTSA No.: M90502

Test Program: NHTSA 35mph NCAP

Test Date: 8/22/08

All Dimensions in Millimeters (mm)	
Item	Value
A	385
B	905
C	2330
D	615
E	1940
F	155
G	1790
H	1155
I	1415
J	913
K	913
L	1559
M	1130
N	1562
O	912
P	912
Q	1423

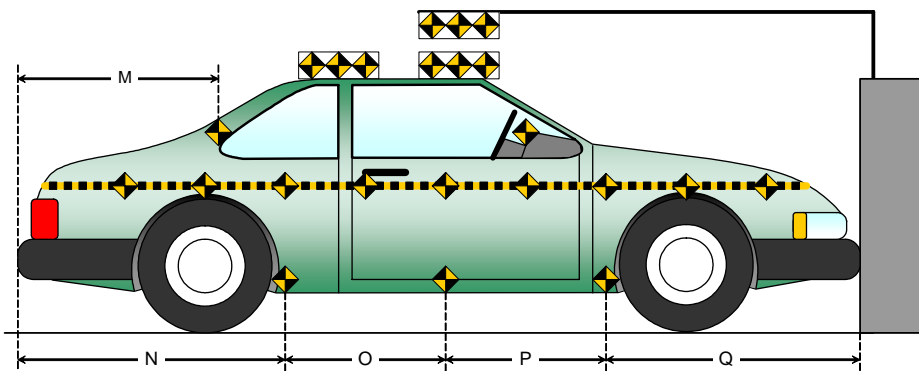
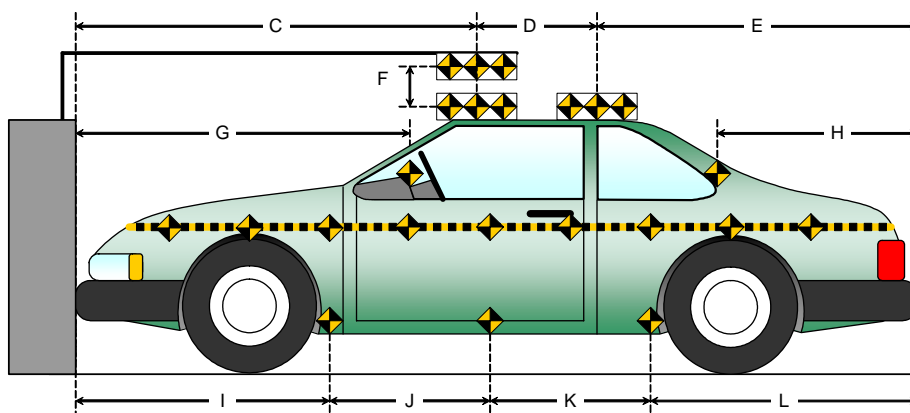
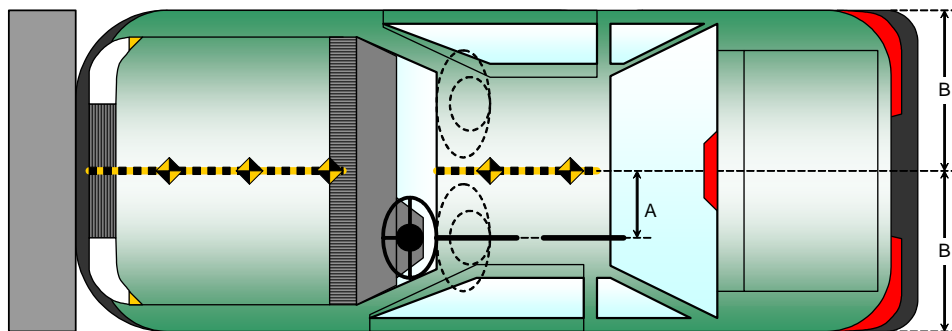

DATA SHEET NO. 16

VEHICLE INTRUSION MEASUREMENTS

Test Vehicle: 2009 Hyundai Sonata 4-Door Sedan

NHTSA No.: M90502

Test Program: NHTSA 35mph NCAP

Test Date: 8/22/08

DOOR OPENING WIDTH TABLE

Item	Description	Units	Pre-Test	Post-Test	Difference
1L	Left Side	mm	981	978	3
2L	Left Side (Diagonally)	mm	1456	1458	-2
3L	Left Side (Diagonally)	mm	951	953	-2
1R	Right Side	mm	981	978	3
2R	Right Side (Diagonally)	mm	1466	1468	-2
3R	Right Side (Diagonally)	mm	941	943	-2

WHEELBASE MEASUREMENT TABLE

Item	Description	Units	Pre-Test	Post-Test	Difference
C	Left Side Wheelbase	mm	2727	2645	82
F	Right Side Wheelbase	mm	2727	2655	72

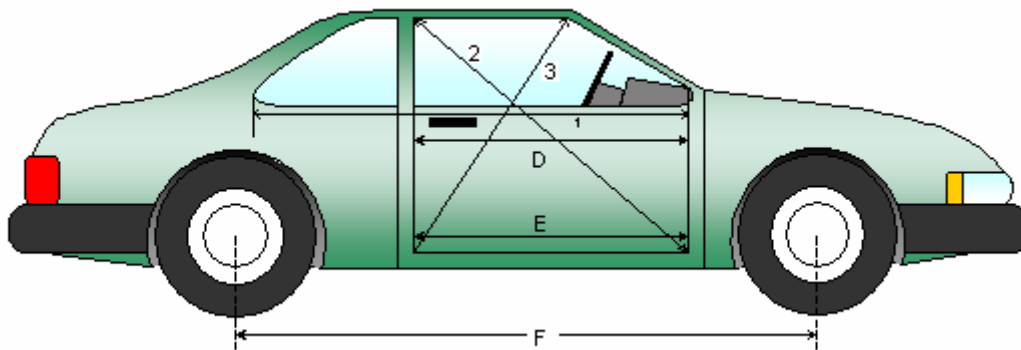
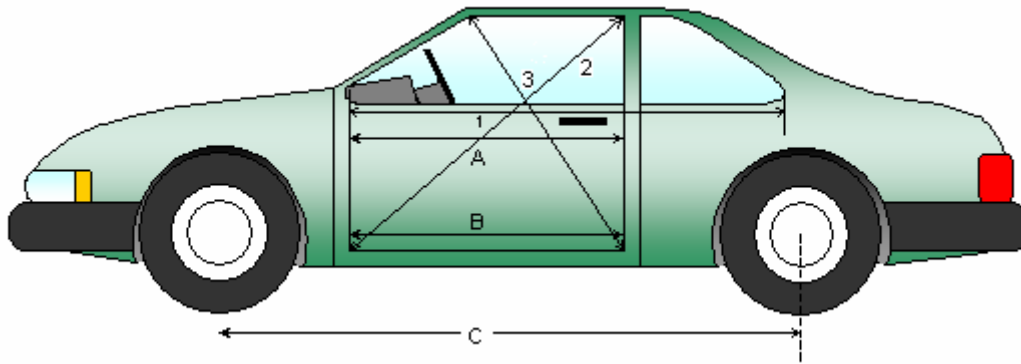

DATA SHEET NO. 16...(CONTINUED)
VEHICLE INTRUSION MEASUREMENTS

Test Vehicle: 2009 Hyundai Sonata 4-Door Sedan
 Test Program: NHTSA 35mph NCAP

NHTSA No.: M90502
 Test Date: 8/22/08

DRIVER COMPARTMENT INTRUSION TABLE

Item	Description	Units	Pre-Test	Post-Test	Difference
AB	Door Opening (Inside Window Jam)	mm	981	978	3
CX	Left Knee Bolster to X	mm	280	280	0
DX	Right Knee Bolster to X	mm	260	255	5
EX	Brake Pedal to X	mm	560	548	12
FX	Foot Rest to X	mm	585	593	-8
GX	Center of Steering Wheel Hub to X	mm	60	100	-40

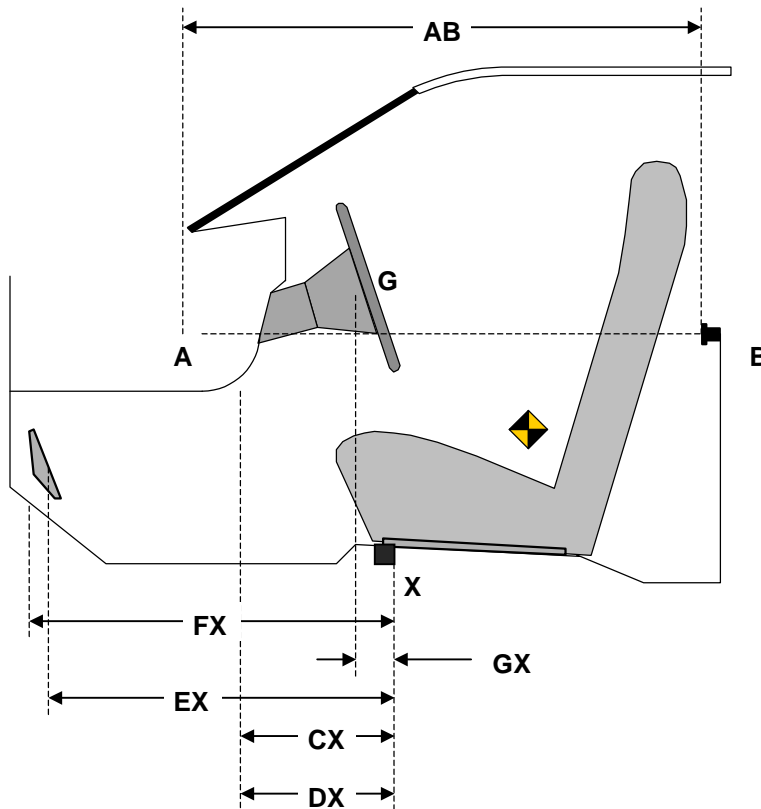

DATA SHEET NO. 16...(CONTINUED)
VEHICLE INTRUSION MEASUREMENTS

Test Vehicle: 2009 Hyundai Sonata 4-Door Sedan
 Test Program: NHTSA 35mph NCAP

NHTSA No.: M90502
 Test Date: 8/22/08

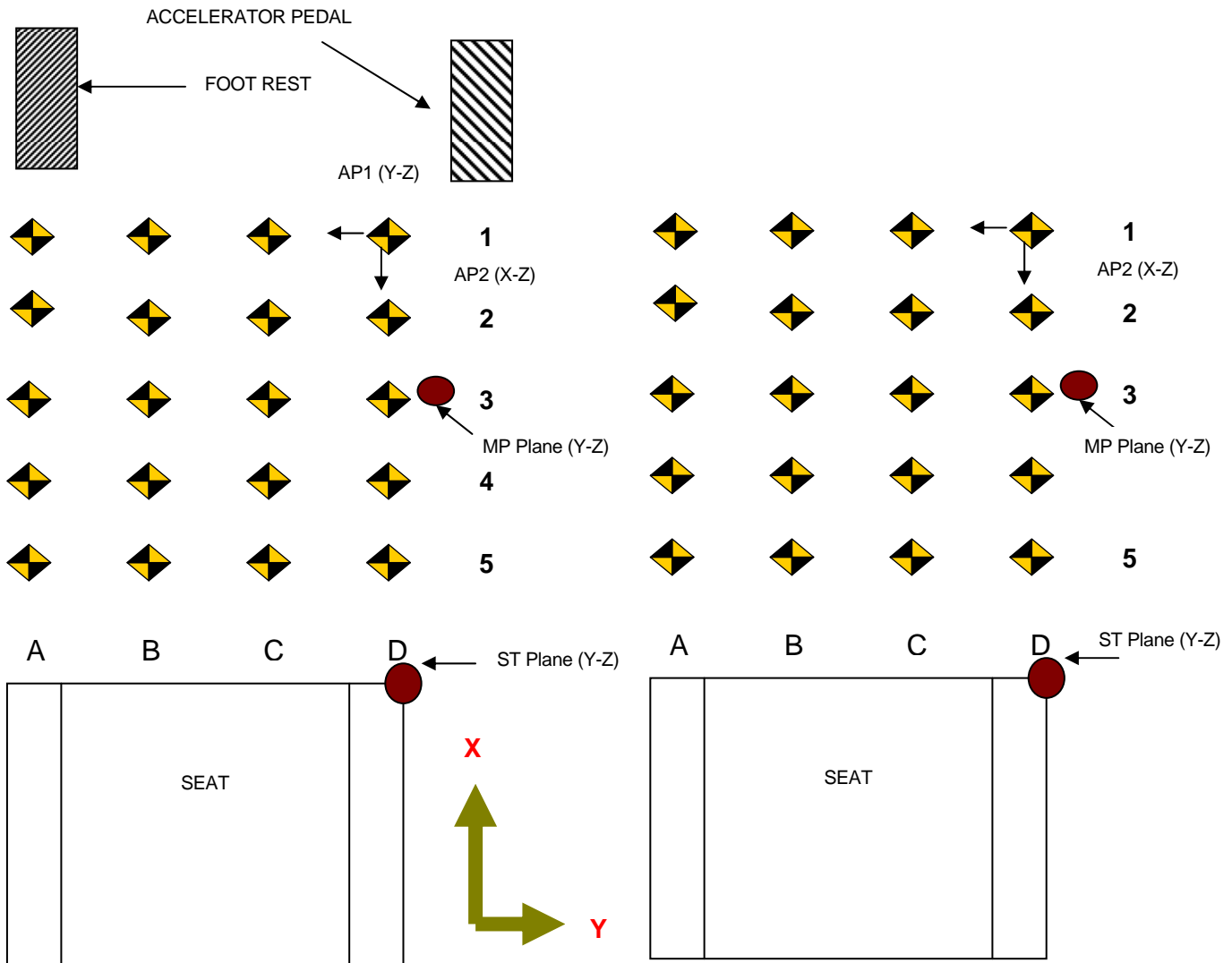

- AP1: Y-Z Plane passing through D1
- AP2: X-Z Plane passing through D1
- AP3: X-Y plane passing through D1
- MP: Y-Z plane, halfway between the ST plane and AP1 plane
- CF Plane: X-Z plane passes through center of footrest.
- BP Plane: X-Z plane passes through center of brake pedal
- TP Plane: Y-Z plane, intersection of BP Plane and the intersection of the toe pan and floorboard
- Column A: intersection of vehicle and CF plane
- Column D: Intersection of vehicle and AP2 plane
- Row 1: intersection of the vehicle and the AP3 Plane
- Row 3: intersection of the vehicle and TP plane
- Row 5: intersection of the vehicle and MP plane
- Row 2: evenly spaced between row 1 and 3
- Row 4: evenly spaced between row 3 and 5

DATA SHEET NO. 16...(CONTINUED)
VEHICLE INTRUSION MEASUREMENTS

Test Vehicle: 2009 Hyundai Sonata 4-Door Sedan

NHTSA No.: M90502

Test Program: NHTSA 35mph NCAP

Test Date: 8/22/08

All measurements in mm

DRIVER FLOORPAN X-AXIS

	Pre-Test				Post-Test				Difference			
	A	B	C	D	A	B	C	D	A	B	C	D
1	672	742	740	724	638	689	668	677	34	53	72	47
2	640	640	644	642	620	596	590	589	20	44	54	53
3	528	525	521	522	512	491	483	477	16	34	38	45
4	395	388	396	391	363	353	354	351	32	35	42	40
5	272	266	264	268	240	232	228	225	32	34	36	43

DRIVER FLOORPAN Y-AXIS

	Pre-Test				Post-Test				Difference			
	A	B	C	D	A	B	C	D	A	B	C	D
1	8	133	248	401	15	152	268	424	-7	-19	-20	-23
2	-18	131	244	407	12	148	260	423	-30	-17	-16	-16
3	7	132	246	408	21	141	259	421	-14	-9	-13	-13
4	13	135	245	404	21	142	255	413	-8	-7	-10	-9
5	17	136	250	402	25	141	255	410	-8	-5	-5	-8

DRIVER FLOORPAN Z-AXIS

	Pre-Test				Post-Test				Difference			
	A	B	C	D	A	B	C	D	A	B	C	D
1	-95	-42	-37	-27	-104	-64	-80	-65	9	22	43	38
2	35	42	50	42	41	28	26	17	-6	14	24	25
3	97	93	92	88	88	87	85	80	9	6	7	8
4	108	96	94	88	89	89	85	75	19	7	9	13
5	118	96	94	99	113	90	84	86	5	6	10	13

DATA SHEET NO. 16...(CONTINUED)

VEHICLE INTRUSION MEASUREMENTS

Test Vehicle: 2009 Hyundai Sonata 4-Door Sedan

NHTSA No.: M90502

Test Program: NHTSA 35mph NCAP

Test Date: 8/22/08

All measurements in mm

PASSENGER FLOORPAN X-AXIS

	Pre-Test				Post-Test				Difference			
	A	B	C	D	A	B	C	D	A	B	C	D
1	761	762	769	705	700	707	718	656	61	55	51	49
2	659	662	665	547	604	610	619	629	55	52	46	42
3	406	538	545	411	480	491	502	508	54	47	43	39
4	286	408	410	287	353	364	367	369	53	44	43	42
5	286	285	283	287	233	240	242	250	53	45	41	37

PASSENGER FLOORPAN Y-AXIS

	Pre-Test				Post-Test				Difference			
	A	B	C	D	A	B	C	D	A	B	C	D
1	-390	-242	-123	-30	-394	-248	-131	-27	4	6	8	-3
2	-405	-247	-126	-4	-410	-250	-129	-11	5	3	3	7
3	-414	-247	-131	-14	-415	-249	-133	-22	1	2	2	8
4	-414	-252	-140	-19	-410	-249	-136	-22	-4	-3	-4	3
5	-418	-258	-142	-15	-411	-250	-137	-17	-7	-8	-5	2

PASSENGER FLOORPAN Z-AXIS

	Pre-Test				Post-Test				Difference			
	A	B	C	D	A	B	C	D	A	B	C	D
1	-51	-49	-54	-93	-73	-69	-70	-99	22	20	16	6
2	31	32	29	29	14	17	18	24	17	15	11	5
3	95	95	94	99	84	87	90	88	11	8	4	11
4	95	97	97	109	82	93	98	85	13	4	-1	24
5	96	98	98	119	79	99	104	107	17	-1	-6	12

DATA SHEET NO. 17

FIXED BARRIER LOAD CELL LOCATIONS

Test Vehicle: 2009 Hyundai Sonata 4-Door Sedan

NHTSA No.: M90502

Test Program: NHTSA 35mph NCAP

Test Date: 8/22/08

36 Load Cell Rigid Barrier (NHTSA Standard)
Load Cell Locations on Fixed Barrier

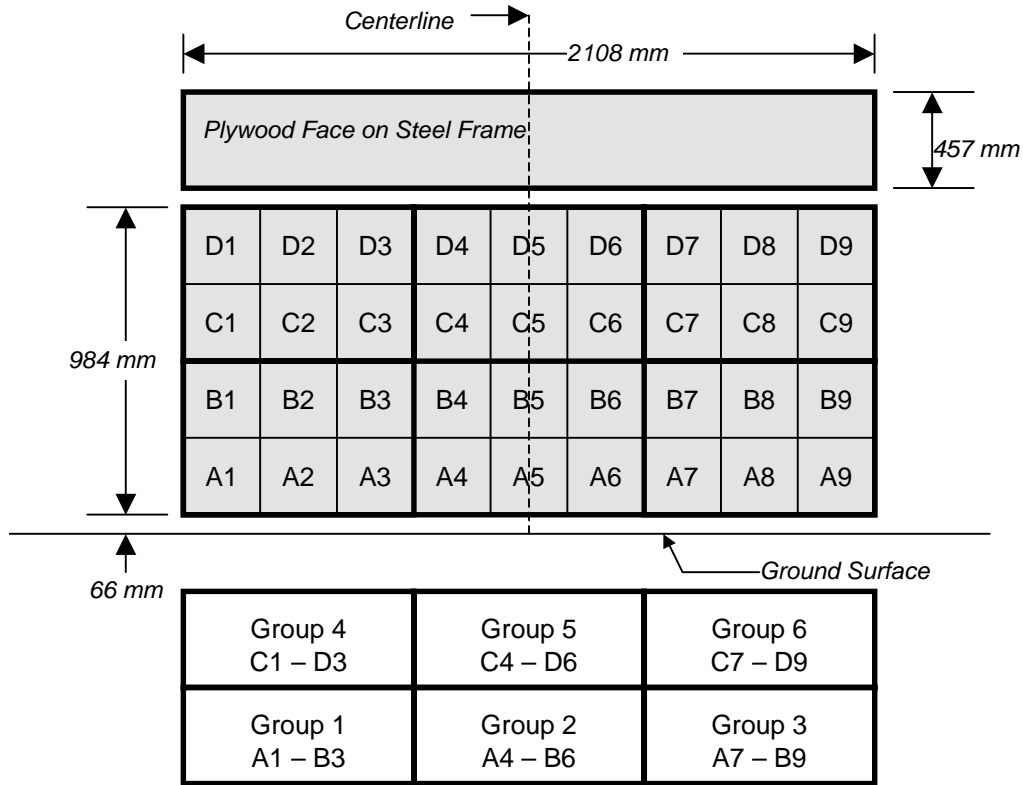

6 Groups of 6 Load Cells Each

DATA SHEET NO. 18

ACCIDENT INVESTIGATION DIVISION DATA

Test Vehicle: 2009 Hyundai Sonata 4-Door Sedan NHTSA No.: M90502
 Test Program: NHTSA 35mph NCAP Test Date: 8/22/08

VEHICLE INFORMATION

VIN: 5NPET46C09H402560 Wheelbase (mm): 2727
 Vehicle Size Category: 4-Door Sedan Test Weight (kg): 1708

ACCELEROMETER DATA

Accelerometer Location: Left rear cross member
 Cal. Procedure/Interval: 6 months/drop test
 Integration Algorithm: NHTSA Standard Linearity: Good
 Impact Velocity (km/h): 56.36
 Velocity Change (km/h): 66.0 Time of Separation (msec): 67.9

CRUSH PROFILE

Collision Deformation Classification: 12FDEW6 Midpoint of Damage: Vehicle Centerline
 Damage Region Length: 1810 Impact Mode: Full frontal

No.	Measurement Description	Units	Pre-Test	Post-Test	Difference
C1	Crush zone 1 at left side of vehicle	mm	210	475	-265
C2	Crush zone 2 on left side of vehicle	mm	65	385	-320
C3	Crush zone 3 on left side of vehicle	mm	20	365	-345
C4	Crush zone 4 on right side of vehicle	mm	20	367	-347
C5	Crush zone 5 on right side of vehicle	mm	65	385	-320
C6	Crush zone 6 at right side of vehicle	mm	210	460	-250

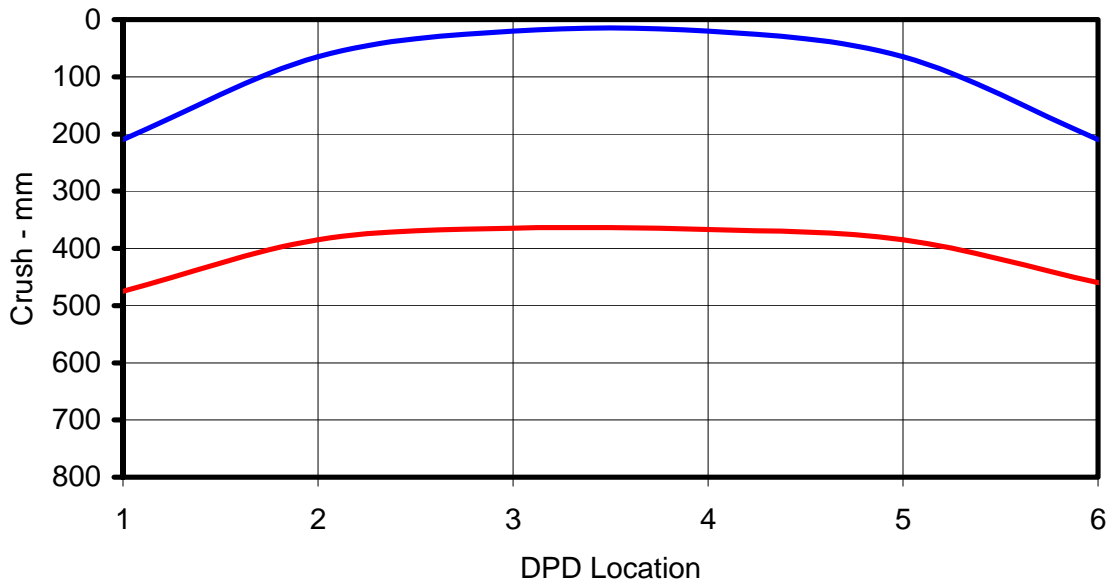

DATA SHEET NO. 19

DUMMY/VEHICLE TEMPERATURE STABILIZATION

Test Vehicle: 2009 Hyundai Sonata 4-Door Sedan

NHTSA No.: M90502

Test Program: NHTSA 35mph NCAP

Test Date: 8/22/08

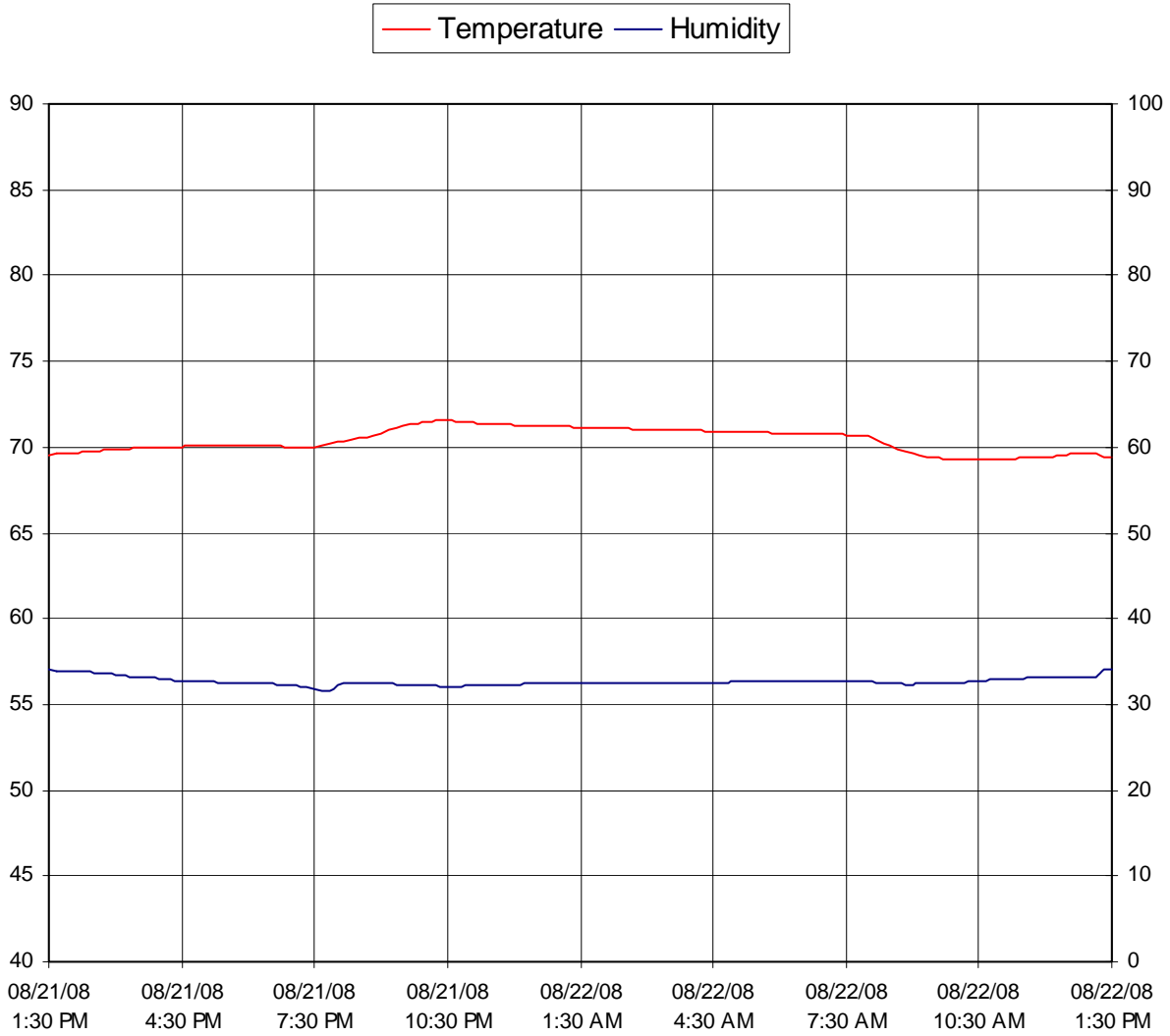

APPENDIX A
PHOTOGRAPHS

LIST OF PHOTOGRAPHS

Figure		Page
A-1	Load Cell Location	A-1
A-2	Manufacturer's Label	A-2
A-3	Tire Placard	A-3
A-4	Right Front $\frac{3}{4}$ View, As Received	A-4
A-5	Left Rear $\frac{3}{4}$ View, As Received	A-5
A-6	Pre-Test Front View	A-6
A-7	Post-Test Front View	A-7
A-8	Pre-Test Left Side View	A-8
A-9	Post-Test Left Side View	A-9
A-10	Pre-Test Right Side View	A-10
A-11	Post-Test Right Side View	A-11
A-12	Pre-Test Right Front $\frac{3}{4}$ View	A-12
A-13	Post-Test Right Front $\frac{3}{4}$ View	A-13
A-14	Pre-Test Left Rear $\frac{3}{4}$ View	A-14
A-15	Post-Test Left Rear $\frac{3}{4}$ View	A-15
A-16	Post-Test Left Side $\frac{3}{4}$ View of Doors After Impact	A-16
A-17	Post-Test Right Side $\frac{3}{4}$ View of Doors After Impact	A-17
A-18	Pre-Test Windshield	A-18
A-19	Post-Test Windshield	A-19
A-20	Pre-Test Engine Compartment	A-20
A-21	Post-Test Engine Compartment (Vehicle Moved)	A-21
A-22	Pre-Test Fuel Cap	A-22
A-23	Post-Test Fuel Cap	A-23
A-24	Pre-Test Front Underbody	A-24
A-25	Post-Test Front Underbody	A-25
A-26	Pre-Test Mid Underbody	A-26
A-27	Post-Test Mid Underbody	A-27
A-28	Pre-Test Rear Underbody	A-28
A-29	Post-Test Rear Underbody	A-29
A-30	Pre-Test Driver Dummy Front View (Head Position)	A-30
A-31	Post-Test Driver Dummy Front View (Head Position)	A-31
A-32	Pre-Test Driver Dummy (Through Window)	A-32
A-33	Post-Test Driver Dummy (Through Window)	A-33
A-34	Pre-Test Driver Dummy (Door Open)	A-34
A-35	Post-Test Driver Dummy (Door Open)	A-35

LIST OF PHOTOGRAPHS...(CONTINUED)

<u>Figure</u>		<u>Page</u>
A-36	Pre-Test Driver Dummy Feet	A-36
A-37	Post-Test Driver Dummy Feet	A-37
A-38	Pre-Test Driver Side Knee Bolster	A-38
A-39	Post-Test Driver Side Knee Bolster	A-39
A-40	Pre-Test Driver Side Floor Pan	A-40
A-41	Post-Test Driver Side Floor Pan	A-41
A-42	Post-Test Driver Dummy Head	A-42
A-43	Post-Test Driver Dummy Airbag Contact	A-43
A-44	Pre-Test Passenger Dummy Front View (Head Position)	A-44
A-45	Post-Test Passenger Dummy Front View (Head Position)	A-45
A-46	Pre-Test Passenger Dummy Front (Through Window)	A-46
A-47	Post-Test Passenger Dummy Front (Through Window)	A-47
A-48	Pre-Test Passenger Dummy (Door Open)	A-48
A-49	Post-Test Passenger Dummy (Door Open)	A-49
A-50	Pre-Test Passenger Dummy Feet	A-50
A-51	Post-Test Passenger Dummy Feet	A-51
A-52	Pre-Test Passenger Side Glove Box	A-52
A-53	Post-Test Passenger Side Glove Box	A-53
A-54	Pre-Test Passenger Side Floor Pan	A-54
A-55	Post-Test Passenger Side Floor Pan	A-55
A-56	Post-Test Passenger Dummy Head	A-56
A-57	Post-Test Passenger Dummy Airbag Contact	A-57
A-58	Vehicle on Rollover Device (0°)	A-58
A-59	Vehicle on Rollover Device (90°)	A-59
A-60	Vehicle on Rollover Device (180°)	A-60
A-61	Vehicle on Rollover Device (270°)	A-61
A-62	Vehicle Impact	A-62

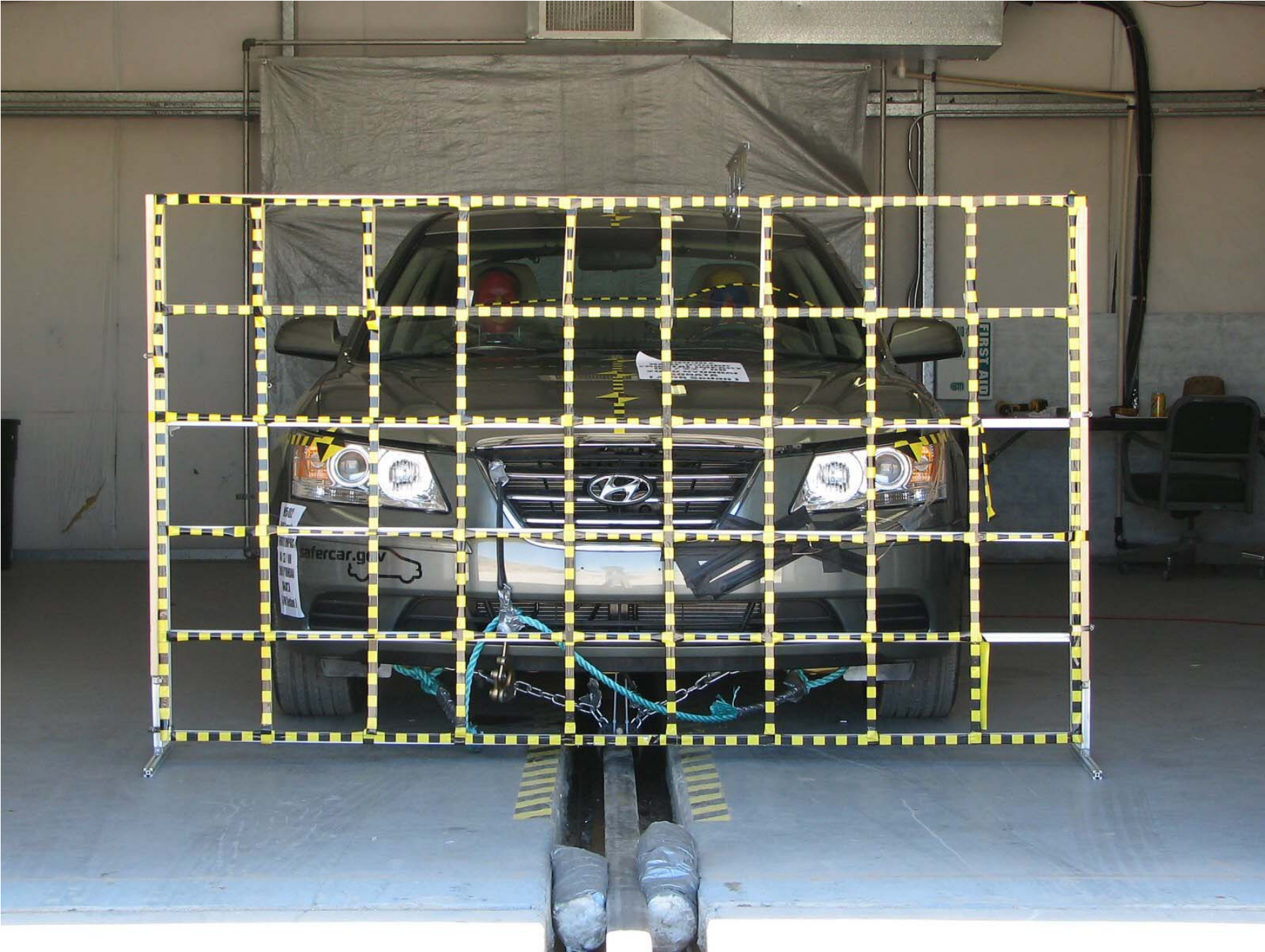

Figure A-1: Load Cell Location



MANUFACTURED BY
HYUNDAI MOTOR MANUFACTURING ALABAMA, LLC

Jan/02/08

GVWR 4299 lbs

PAINT GP

GAWR
FRONT 2513 lbs

GAWR
REAR 2138 lbs

TRIM V2

THIS VEHICLE CONFORMS TO ALL APPLICABLE U.S.A. FEDERAL
MOTOR VEHICLE SAFETY, BUMPER, AND THEFT PREVENTION STANDARDS
IN EFFECT ON THE DATE OF MANUFACTURE SHOWN ABOVE

V.I.N 5NPET46C09H402560

PASSENGER CAR



Figure A-2: Manufacturer's Label



TIRE AND LOADING INFORMATION

SEATING CAPACITY | TOTAL 5 | FRONT 2 | REAR 3

The combined weight of occupants and cargo should never exceed 390 kg or 860 lbs.

TIRE	SIZE	COLD TIRE PRESSURE	SEE OWNER'S MANUAL FOR ADDITIONAL INFORMATION
FRONT	P215/60R16	220KPA, 32PSI	
REAR	P215/60R16	220KPA, 32PSI	
SPARE	T125/80D16	420KPA, 60PSI	

F1
P215/60R16

Figure A-3: Tire Placard



Figure A-4: Right Front $\frac{3}{4}$ View, As Received



A-5

TR-P28001-22-NC

Figure A-5: Left Rear $\frac{3}{4}$ View, as Received



Figure A-6: Pre-Test Front View

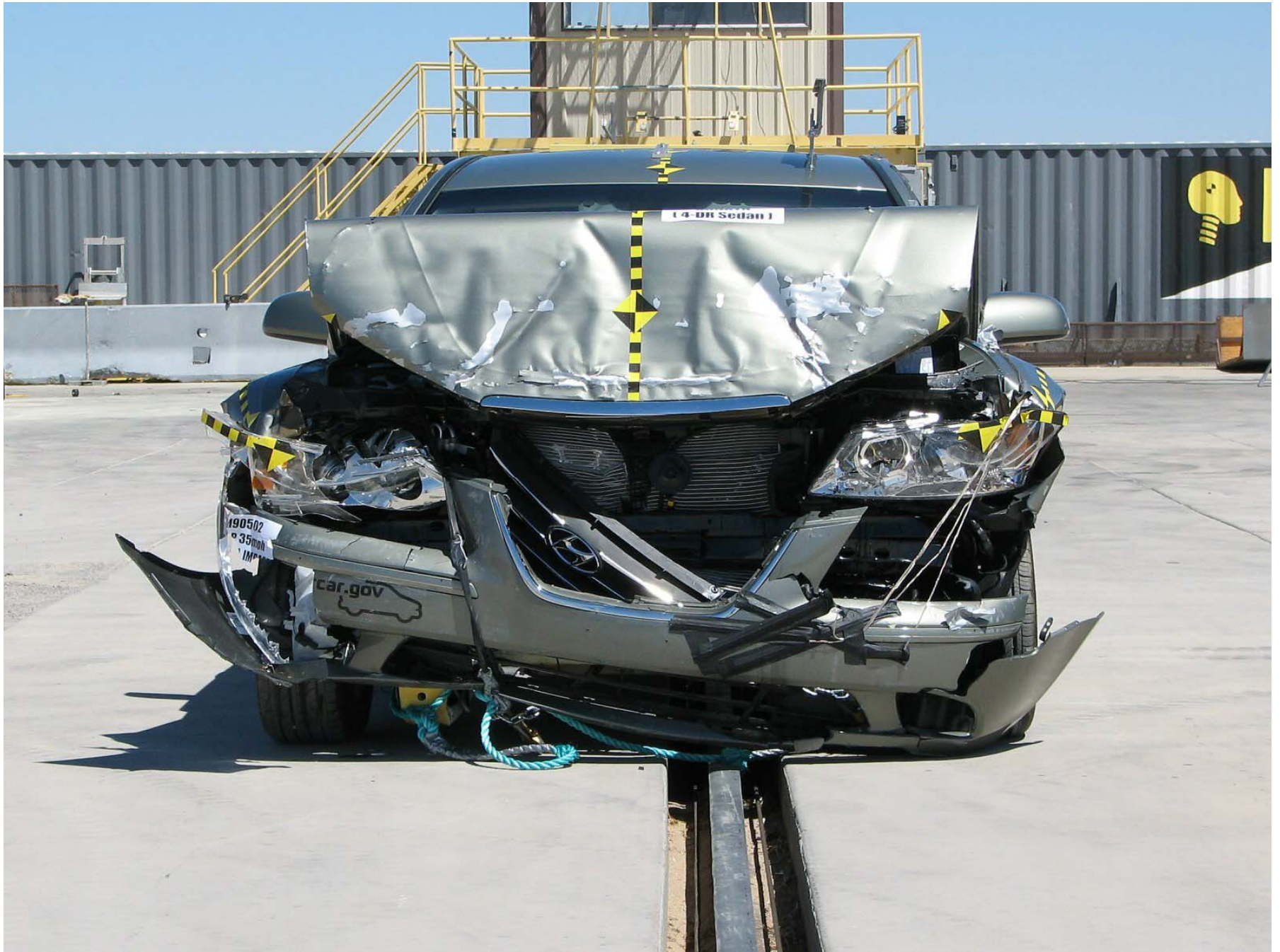

Figure A-7: Post-Test Front View (Vehicle Moved)



Figure A-8: Pre-Test Left Side View



Figure A-9: Post-Test Left Side View



Figure A-10: Pre-Test Right Side View



Figure A-11: Post-Test Right Side View



Figure A-12: Pre-Test Right Front 3/4 View



Figure A-13: Post-Test Right Front 3/4 View (Vehicle Moved)



Figure A-14: Pre-Test Left Rear ¾ View



Figure A-15: Post-Test Left Rear $\frac{3}{4}$ View



Figure A-16: Post-Test Left Side 3/4 View of Doors After Impact



Figure A-17: Post-Test Right Side 3/4 View of Doors After Impact

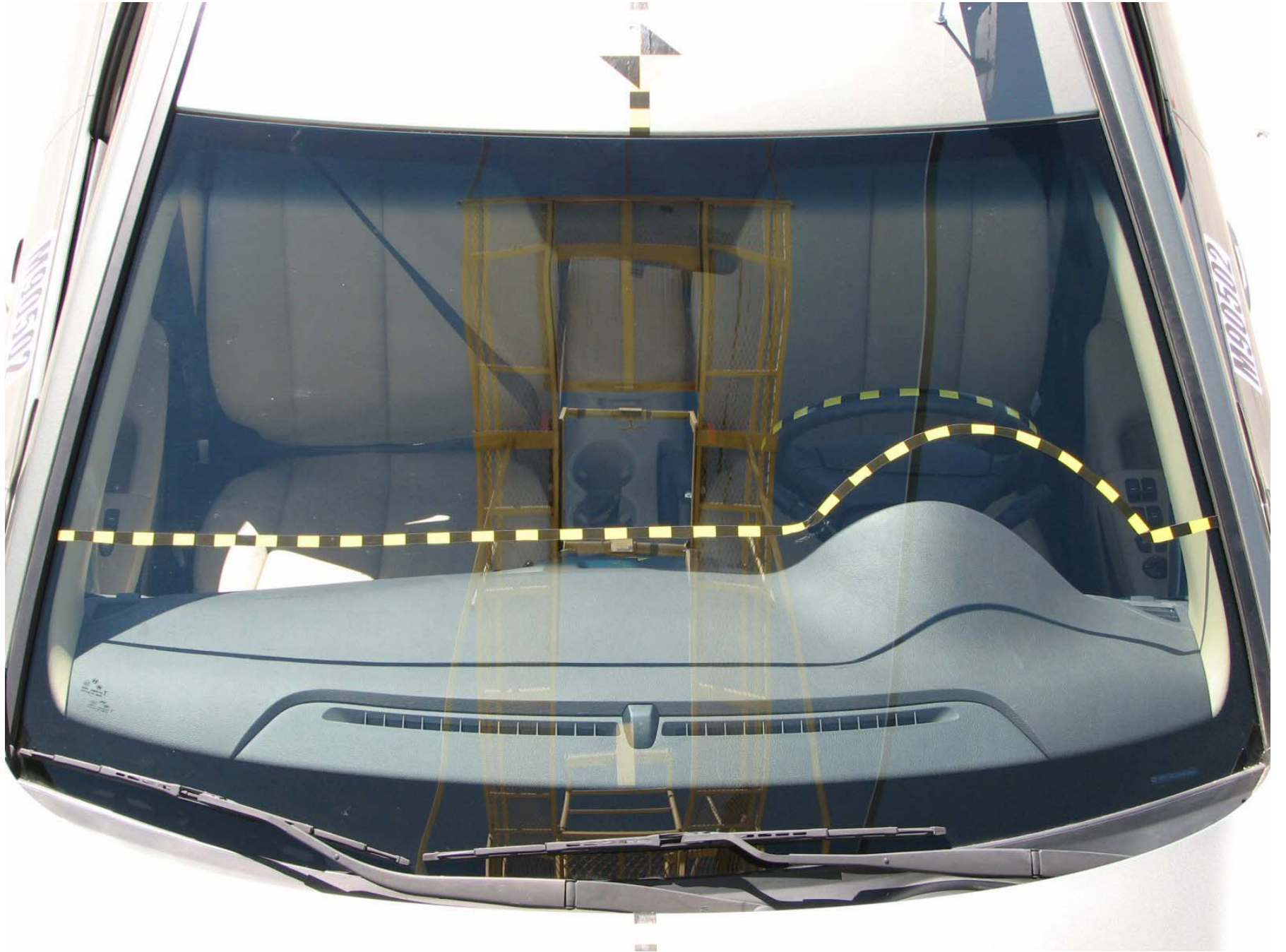

Figure A-18: Pre-Test Windshield



Figure A-19: Post-Test Windshield



Figure A-20: Pre-Test Engine Compartment



Figure A-21: Post-Test Engine Compartment (Vehicle Moved)



Figure A-22: Pre-Test Fuel Cap



**2009 HYUNDAI SONATA
M90502
08/22/08
STODDARD SOLVENT ADDED
16.46 GALLONS
(62.30 LITERS)**

WARNING
Fuel Spill May Cause Fire
REMOVE SLOWLY
Tighten Until Cap Clicks
Or Service Engine Light
May Turn On

Figure A-23: Post-Test Fuel Cap

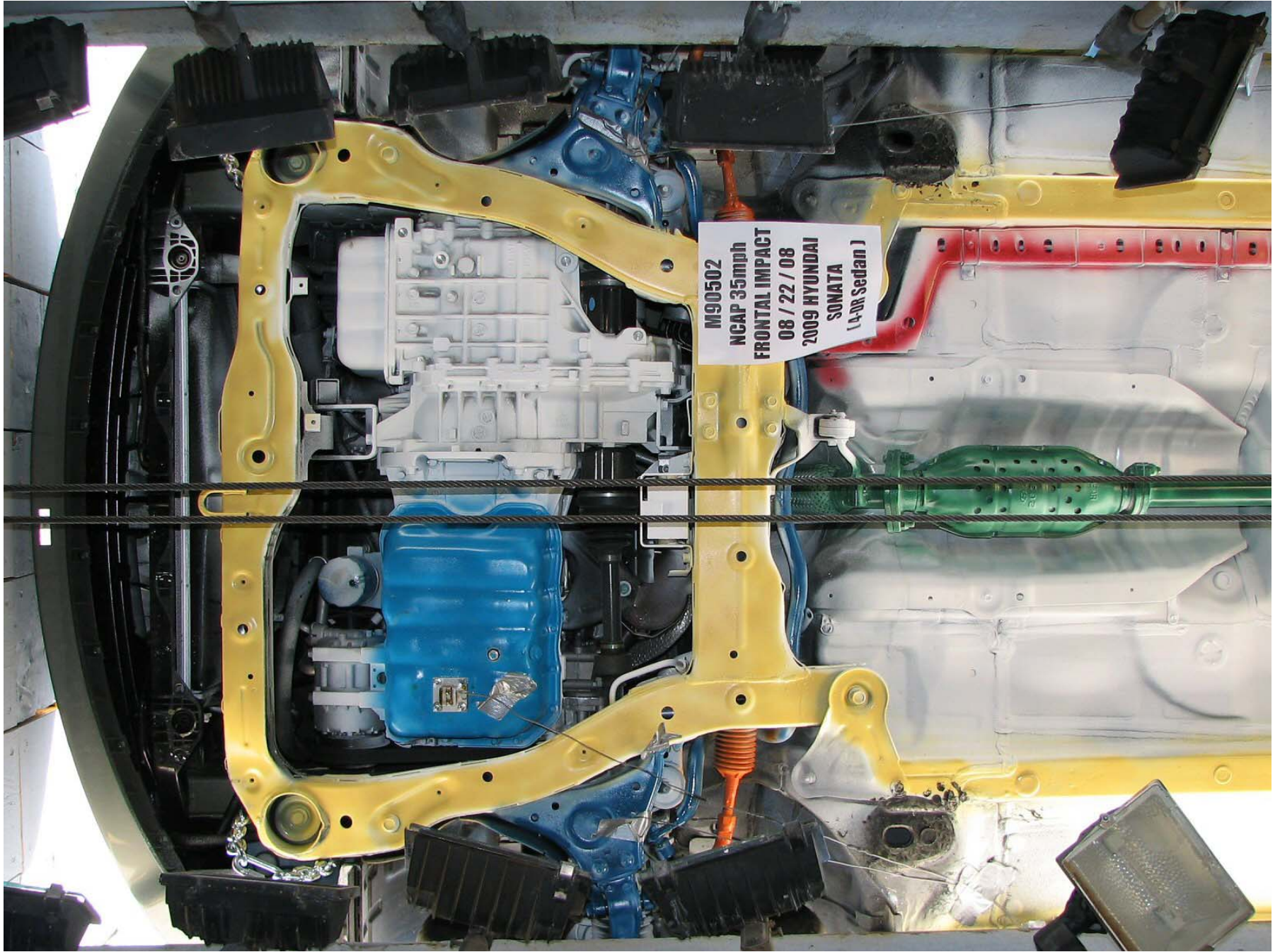

Figure A-24: Pre-Test Front Underbody

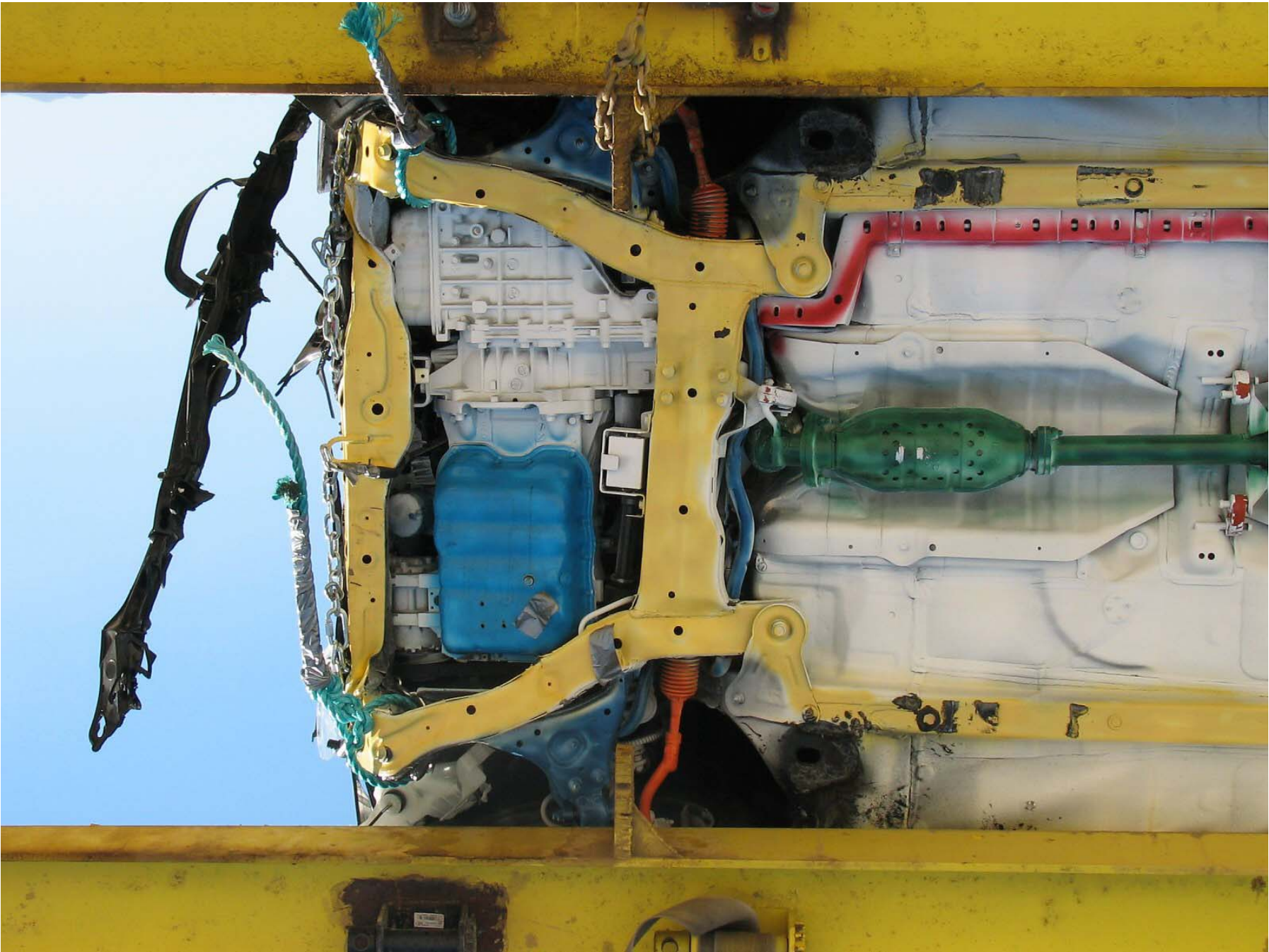

Figure A-25: Post-Test Front Underbody

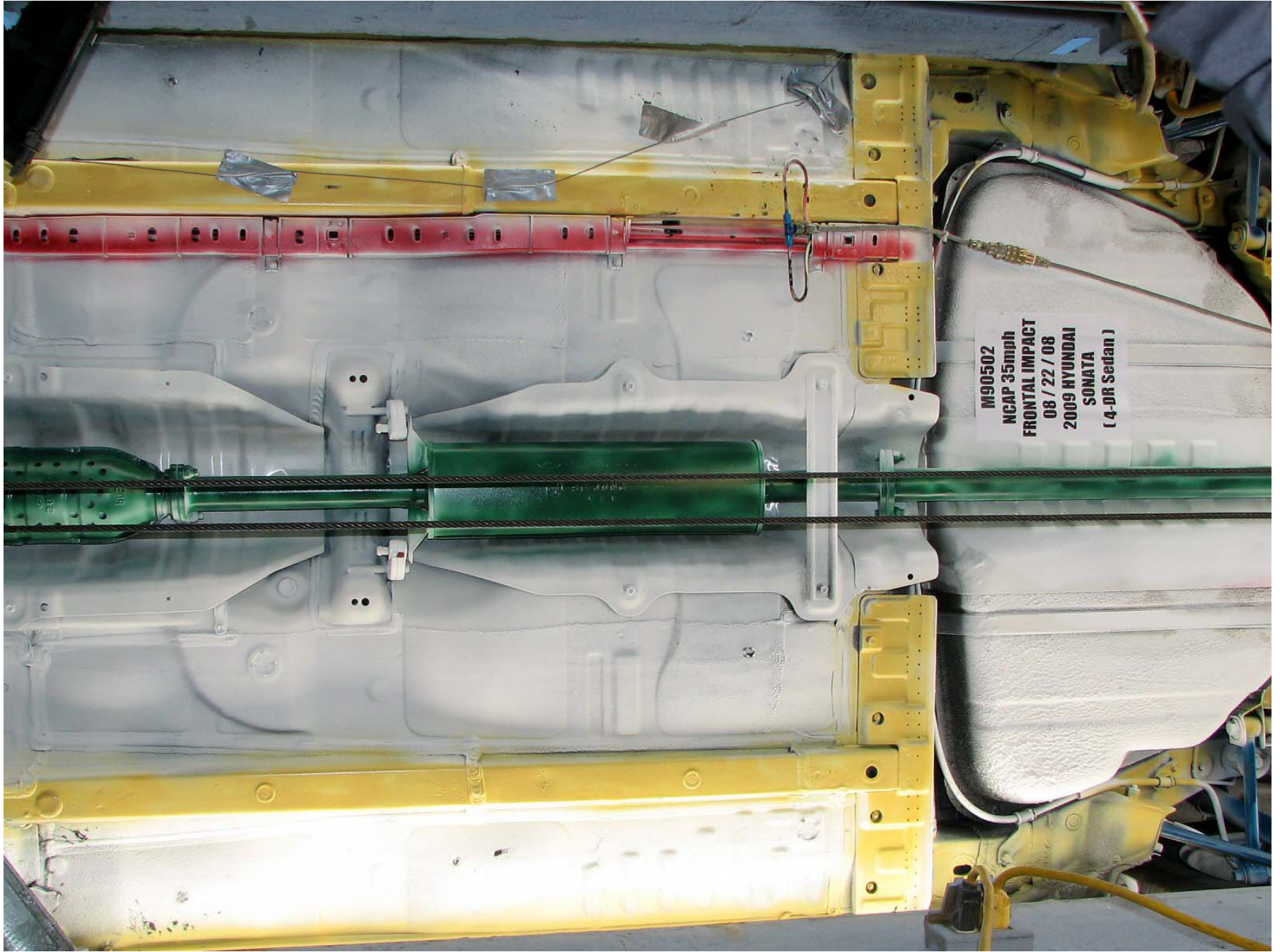

Figure A-26: Pre-Test Mid Underbody

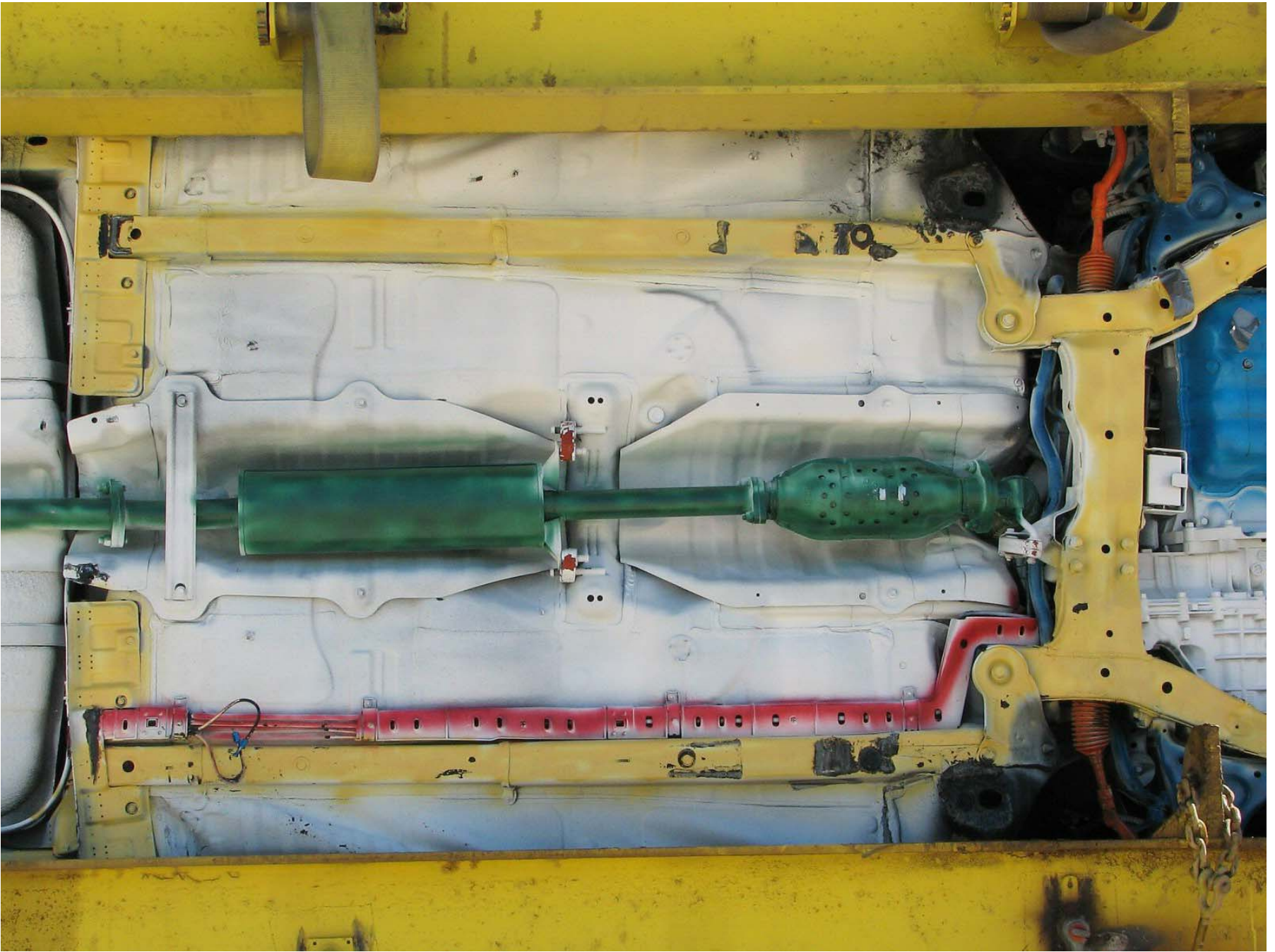

Figure A-27: Post-Test Mid Underbody

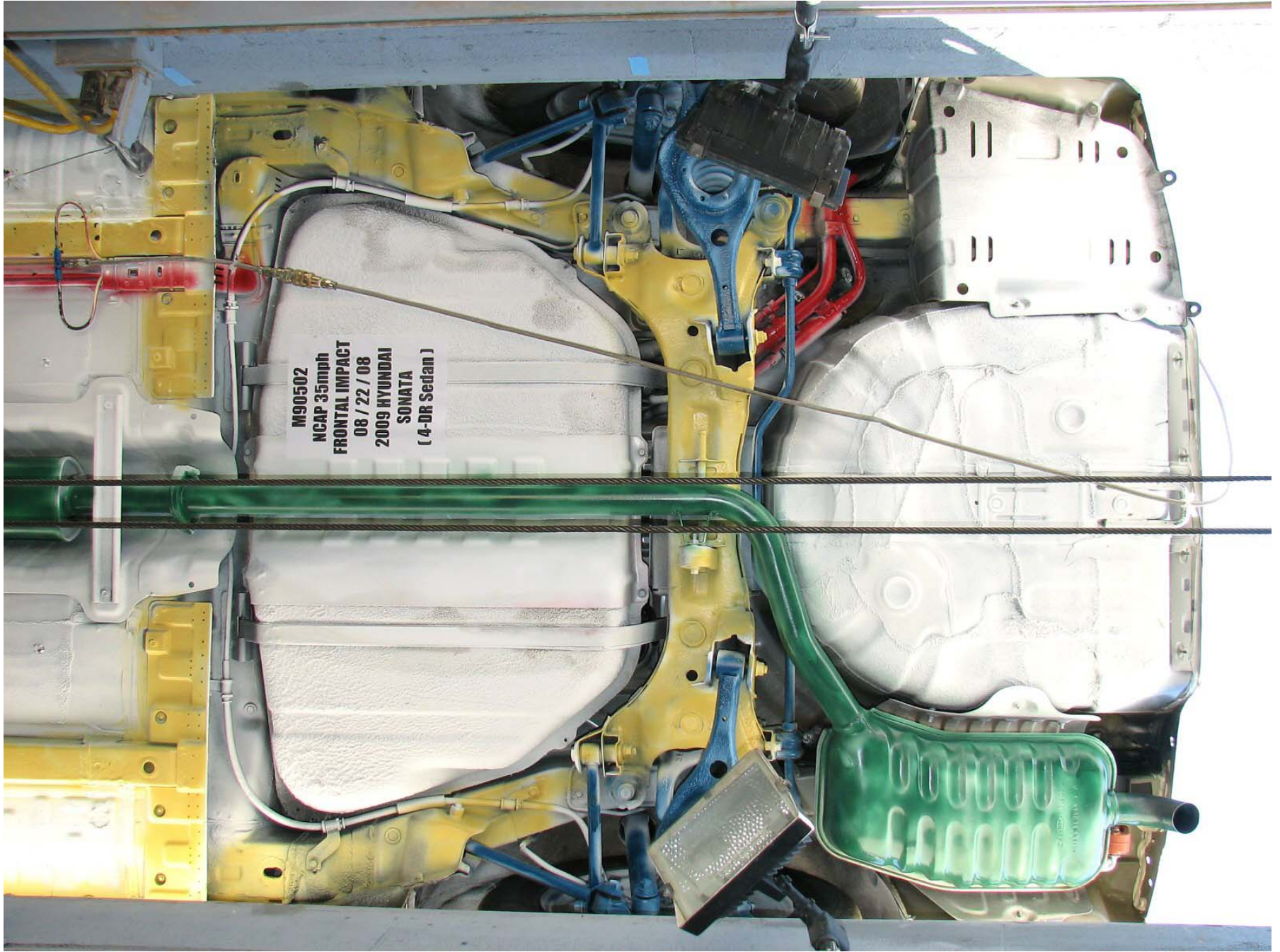

Figure A-28: Pre-Test Rear Underbody

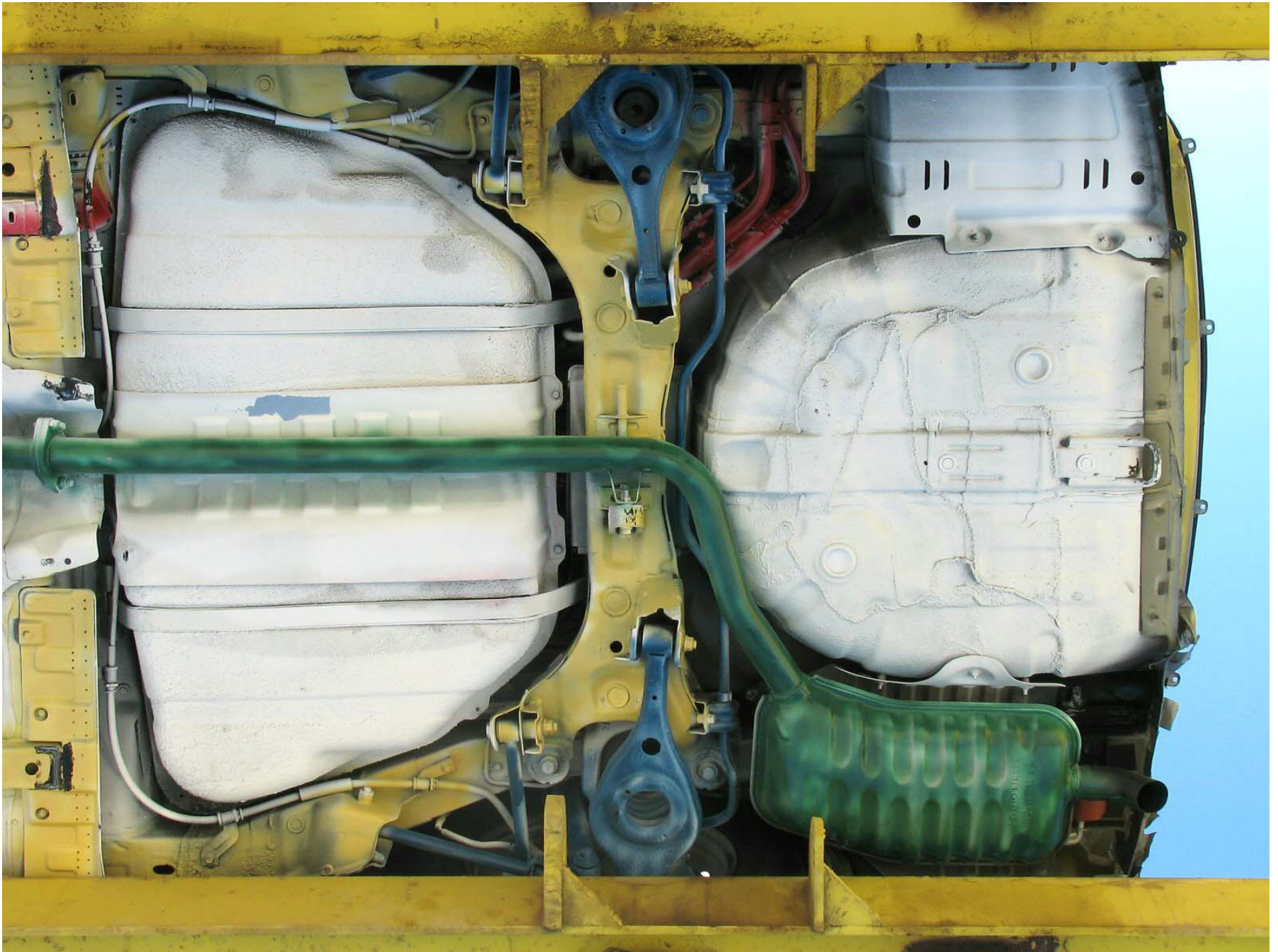

Figure A-29: Post-Test Rear Underbody



Figure A-30: Pre-Test Driver Dummy Front View (Head Position)



Figure A-31: Post-Test Driver Dummy Front View (Head Position)



Figure A-32: Pre-Test Driver Dummy (Through Window)



Figure A-33: Post-Test Driver Dummy (Through Window)



Figure A-34: Pre-Test Driver Dummy (Door Open)



Figure A-35: Post-Test Driver Dummy (Door Open)



Figure A-36: Pre-Test Driver Dummy Feet



Figure A-37: Post-Test Driver Dummy Feet



Figure A-38: Pre-Test Driver Side Knee Bolster

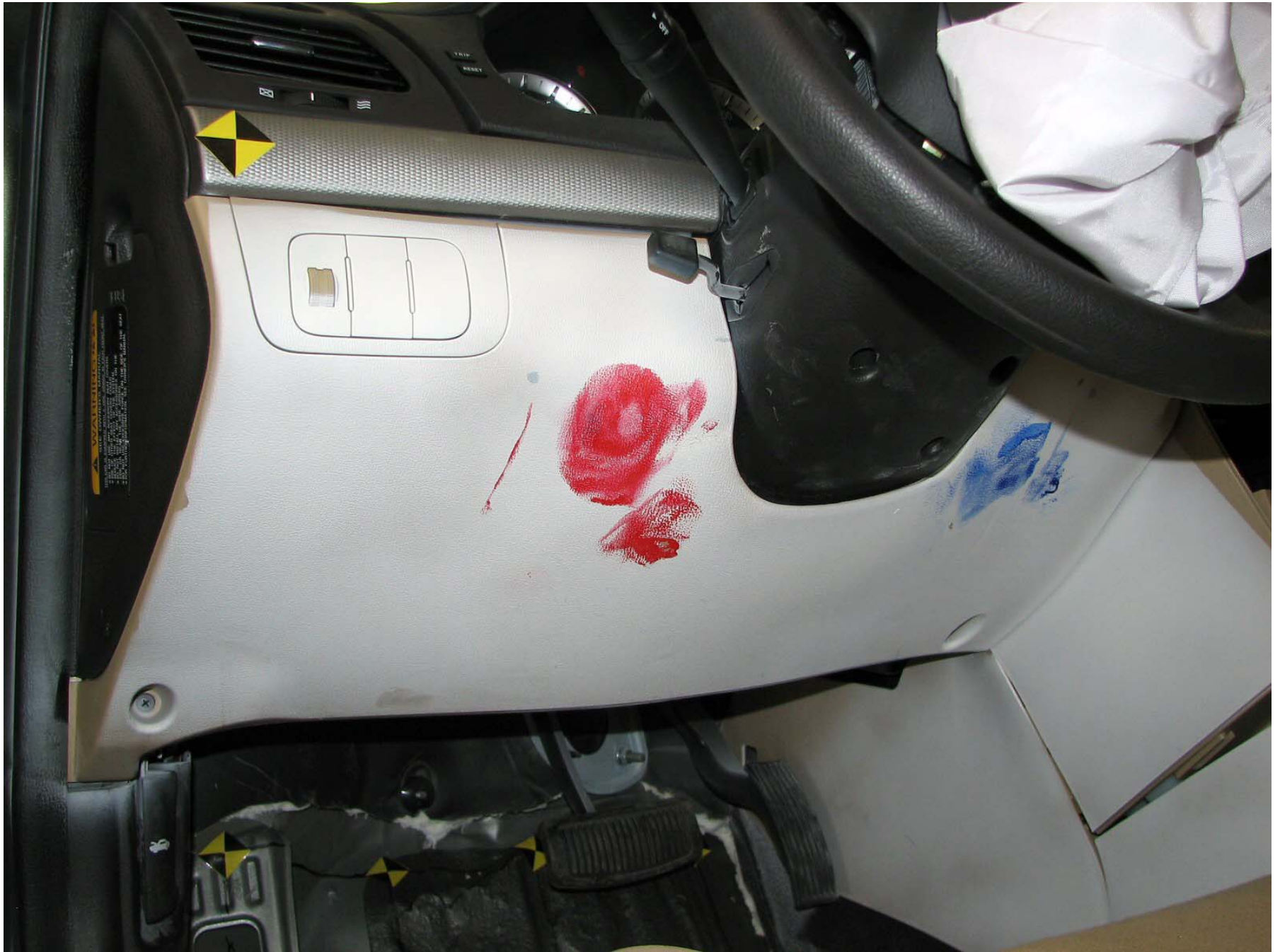

Figure A-39: Post-Test Driver Side Knee Bolster



Figure A-40: Pre-Test Driver Side Floor Pan



Figure A-41: Post-Test Driver Side Floor Pan



Figure A-42: Post-Test Driver Dummy Head



Figure A-43: Post-Test Driver Dummy Airbag Contact



Figure A-44: Pre-Test Passenger Dummy Front View (Head Position)



Figure A-45: Post-Test Passenger Dummy Front View (Head Position)



Figure A-46: Pre-Test Passenger Dummy (Through Window)



Figure A-47: Post-Test Passenger Dummy (Through Window)



Figure A-48: Pre-Test Passenger Dummy (Door Open)



Figure A-49: Post-Test Passenger Dummy (Door Open)



Figure A-50: Pre-Test Passenger Dummy Feet



Figure A-51: Post-Test Passenger Dummy Feet



Figure A-52: Pre-Test Passenger Side Glove Box



Figure A-53: Post-Test Passenger Side Glove Box



Figure A-54: Pre-Test Passenger Side Floor Pan



Figure A-55: Post-Test Passenger Side Floor Pan



Figure A-56: Post-Test Passenger Dummy Head



Figure A-57: Post-Test Passenger Dummy Airbag Contact



A-58

TR-P28001-22-NC

Figure A-58: Vehicle on Rollover Device (0°)



Figure A-59: Vehicle on Rollover Device (90°)



Figure A-60: Vehicle on Rollover Device (180°)

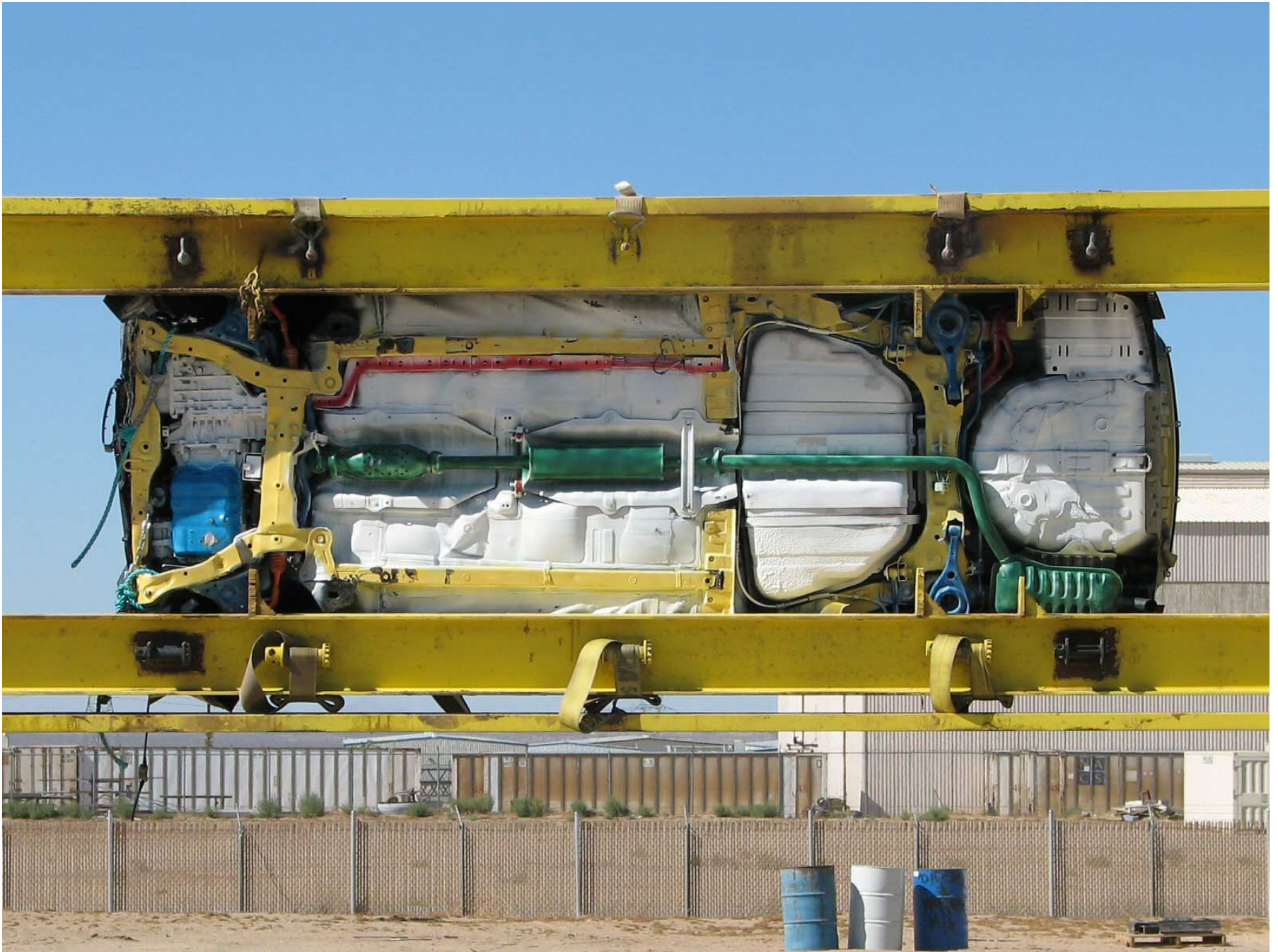

Figure A-61: Vehicle on Rollover Device (270°)

A-61

TR-P28001-22-NC



Figure A-62: Vehicle Impact

APPENDIX B
DATA PLOTS

LIST OF DATA PLOTS

Data Plot	Page	
B-1	Driver Head Primary X	B-1
	Driver Head Primary Y	B-1
	Driver Head Primary Z	B-1
	Driver Head Resultant Primary	B-1
B-2	Driver Chest Primary X	B-2
	Driver Chest Primary Y	B-2
	Driver Chest Primary Z	B-2
	Driver Chest Resultant Primary	B-2
B-3	Driver Left Femur Force Z	B-3
	Driver Right Femur Force Z	B-3
B-4	Passenger Head Primary X	B-4
	Passenger Head Primary Y	B-4
	Passenger Head Primary Z	B-4
	Passenger Head Resultant Primary	B-4
B-5	Passenger Chest Primary X	B-5
	Passenger Chest Primary Y	B-5
	Passenger Chest Primary Z	B-5
	Passenger Chest Resultant Primary	B-5
B-6	Passenger Left Femur Force Z	B-6
	Passenger Right Femur Force Z	B-6

LIST OF DATA PLOTS...(CONTINUED)

The following additional data plots for this test can be obtained from the research and development section of the NHTSA website. The website can be found at www.NHTSA.dot.gov.

Driver Head Primary X Velocity
Driver Head Primary X Displacement
Driver Head Redundant X
Driver Head Redundant Y
Driver Head Redundant Z
Driver Head Resultant Redundant
Driver Head Redundant X Velocity
Driver Head Redundant X Displacement
Driver Upper Neck Force X
Driver Upper Neck Force Y
Driver Upper Neck Force Z
Driver Upper Neck Force Resultant
Driver Upper Neck Moment X
Driver Upper Neck Moment Y
Driver Upper Neck Moment Z
Driver Upper Neck Moment Resultant
Driver Chest Primary X Velocity
Driver Chest Primary X Displacement
Driver Chest Redundant X
Driver Chest Redundant Y
Driver Chest Redundant Z
Driver Chest Resultant Redundant
Driver Chest Redundant X Velocity
Driver Chest Redundant X Displacement
Driver Chest Displacement
Driver Pelvis X
Driver Pelvis Y
Driver Pelvis Z
Driver Pelvis Resultant
Driver Pelvis X Velocity
Driver Pelvis X Displacement
Driver Left Upper Tibia Moment X
Driver Left Upper Tibia Moment Y
Driver Right Upper Tibia Moment X

LIST OF DATA PLOTS...(CONTINUED)

Driver Right Upper Tibia Moment Y
Driver Left Lower Tibia Moment X
Driver Left Lower Tibia Moment Y
Driver Left Lower Tibia Force Z
Driver Right Lower Tibia Moment X
Driver Right Lower Tibia Moment Y
Driver Right Lower Tibia Force Z
Driver Left Foot Aft X
Driver Left Foot Aft Z
Driver Left Foot Fore Z
Driver Right Foot Aft X
Driver Right Foot Aft Z
Driver Right Foot Fore Z
Driver Lap Belt Force
Driver Shoulder Belt Force
Driver Shoulder Belt Pullout
Driver Shoulder Belt Elongation
Passenger Head Primary X Velocity
Passenger Head Primary X Displacement
Passenger Head Redundant X
Passenger Head Redundant Y
Passenger Head Redundant Z
Passenger Head Resultant Redundant
Passenger Head Redundant X Velocity
Passenger Head Redundant X Displacement
Passenger Upper Neck Force X
Passenger Upper Neck Force Y
Passenger Upper Neck Force Z
Passenger Upper Neck Force Resultant
Passenger Upper Neck Moment X
Passenger Upper Neck Moment Y
Passenger Upper Neck Moment Z
Passenger Upper Neck Moment Resultant
Passenger Chest Primary X Velocity
Passenger Chest Primary X Displacement
Passenger Chest Redundant X

LIST OF DATA PLOTS...(CONTINUED)

Passenger Chest Redundant Y
Passenger Chest Redundant Z
Passenger Chest Resultant Redundant
Passenger Chest Redundant X Velocity
Passenger Chest Redundant X Displacement
Passenger Chest Displacement
Passenger Pelvis X
Passenger Pelvis Y
Passenger Pelvis Z
Passenger Pelvis Resultant
Passenger Pelvis X Velocity
Passenger Pelvis X Displacement
Passenger Left Femur Force
Passenger Right Femur Force
Passenger Left Upper Tibia Moment X
Passenger Left Upper Tibia Moment Y
Passenger Right Upper Tibia Moment X
Passenger Right Upper Tibia Moment Y
Passenger Left Lower Tibia Moment X
Passenger Left Lower Tibia Moment Y
Passenger Left Lower Tibia Force Z
Passenger Right Lower Tibia Moment X
Passenger Right Lower Tibia Moment Y
Passenger Right Lower Tibia Force Z
Passenger Left Foot Aft X
Passenger Left Foot Aft Z
Passenger Left Foot Fore Z
Passenger Right Foot Aft X
Passenger Right Foot Aft Z
Passenger Right Foot Fore Z
Passenger Lap Belt Force
Passenger Shoulder Belt Force
Passenger Shoulder Belt Pullout
Passenger Shoulder Belt Elongation
Vehicle Left Rear X
Vehicle Left Rear X Velocity

LIST OF DATA PLOTS...(CONTINUED)

Vehicle Left Rear X Displacement
Vehicle Right Rear X
Vehicle Right Rear X Velocity
Vehicle Right Rear X Displacement
Vehicle Engine Top
Vehicle Engine Top Velocity
Vehicle Engine Top Displacement
Vehicle Engine Bottom
Vehicle Engine Bottom Velocity
Vehicle Engine Bottom Displacement
Vehicle Left Brake Caliper
Vehicle Left Brake Caliper Velocity
Vehicle Left Brake Caliper Displacement
Vehicle Right Brake Caliper
Vehicle Right Brake Caliper Velocity
Vehicle Right Brake Caliper Displacement
Vehicle Instrument Panel
Vehicle Instrument Panel Velocity
Vehicle Instrument Panel Displacement
Vehicle Left Rear Z
Vehicle Left Rear Z Velocity
Vehicle Left Rear Z Displacement
Vehicle Right Rear Z
Vehicle Right Rear Z Velocity
Vehicle Right Rear Z Displacement

Test Vehicle: 2009 Hyundai Sonata 4-Door Sedan
 Test Program: NHTSA 35mph NCAP

Test Date: 8/22/08
 NHTSA No.: M90502

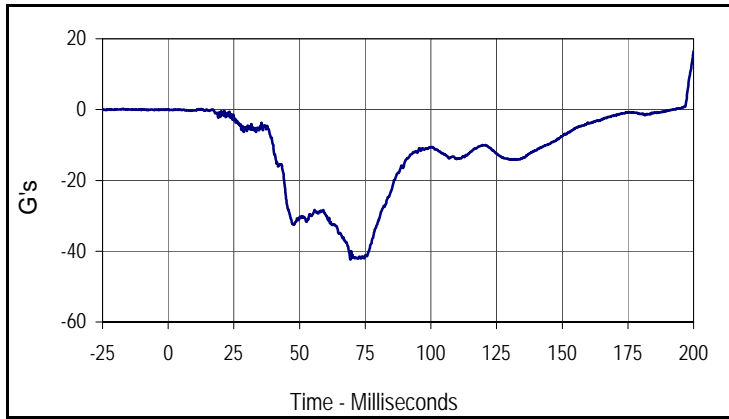

Curve Description			
Driver Head Primary X			
CURNO	Type	SAE Class	Units
001	FIL	1000	G's
Max	Time	Min	Time
16.5	200.0	-42.3	69.3

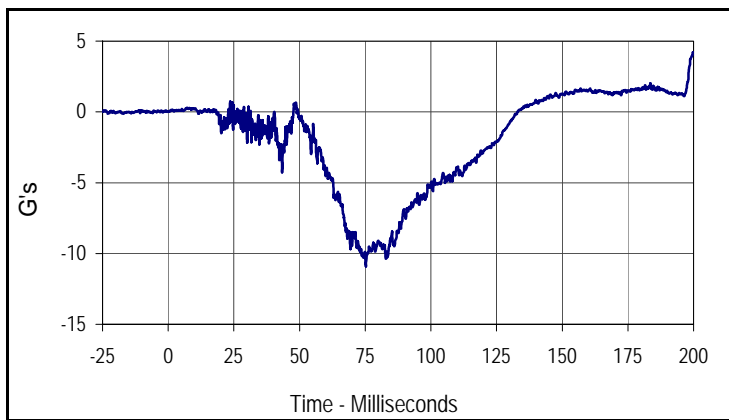

Curve Description			
Driver Head Primary Y			
CURNO	Type	SAE Class	Units
002	FIL	1000	G's
Max	Time	Min	Time
4.2	199.8	-10.9	75.2

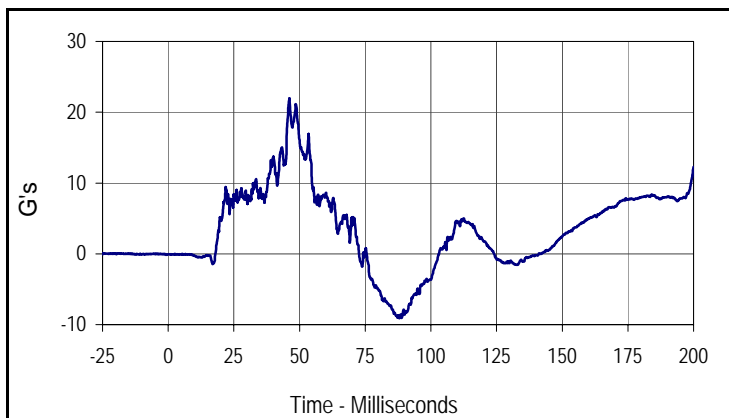

Curve Description			
Driver Head Primary Z			
CURNO	Type	SAE Class	Units
003	FIL	1000	G's
Max	Time	Min	Time
21.9	46.1	-9.1	87.9

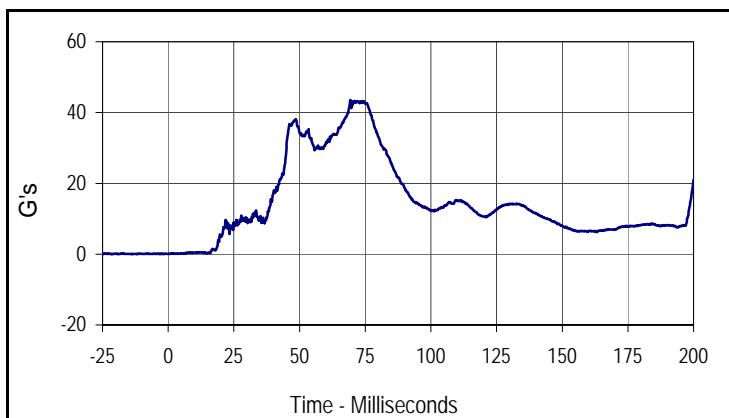

Curve Description			
Driver Head Resultant Primary			
CURNO	Type	SAE Class	Units
001	RES	1000	G's
Max	Time	Min	Time
43.5	69.4	0.1	0.2

Test Vehicle: 2009 Hyundai Sonata 4-Door Sedan
 Test Program: NHTSA 35mph NCAP

Test Date: 8/22/08
 NHTSA No.: M90502

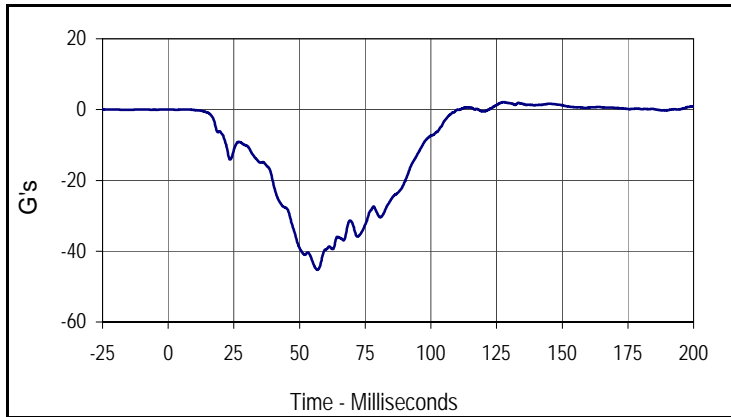

Curve Description			
Driver Chest Primary X			
CURNO	Type	SAE Class	Units
004	FIL	180	G's
Max	Time	Min	Time
2.1	127.7	-45.3	56.8

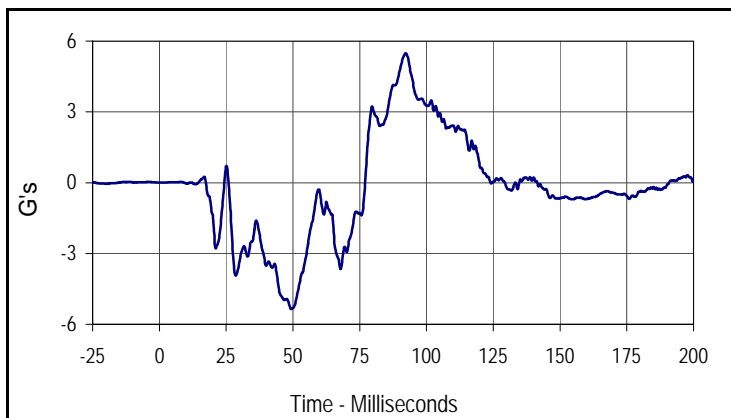

Curve Description			
Driver Chest Primary Y			
CURNO	Type	SAE Class	Units
005	FIL	180	G's
Max	Time	Min	Time
5.5	92.2	-5.4	49.3

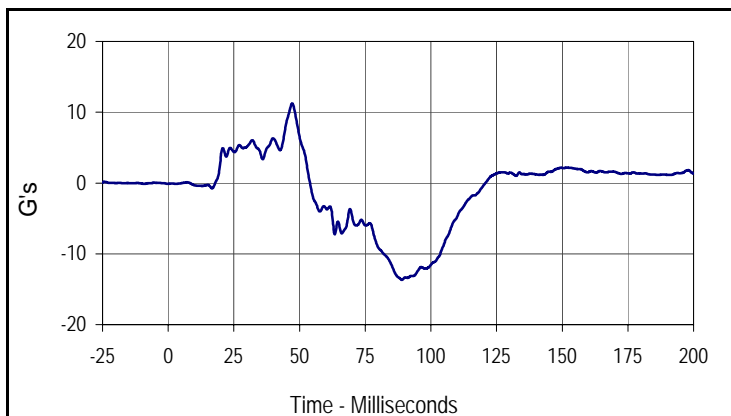

Curve Description			
Driver Chest Primary Z			
CURNO	Type	SAE Class	Units
006	FIL	180	G's
Max	Time	Min	Time
11.2	47.2	-13.7	88.9

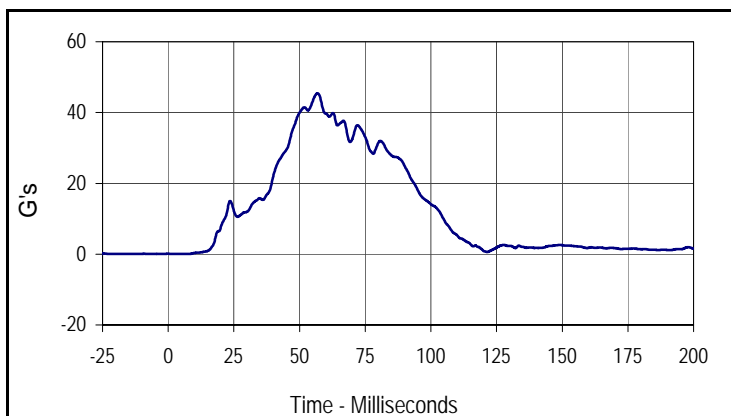

Curve Description			
Driver Chest Resultant Primary			
CURNO	Type	SAE Class	Units
004	RES	180	G's
Max	Time	Min	Time
45.4	56.9	0.0	5.3

Test Vehicle: 2009 Hyundai Sonata 4-Door Sedan
 Test Program: NHTSA 35mph NCAP

Test Date: 8/22/08
 NHTSA No.: M90502

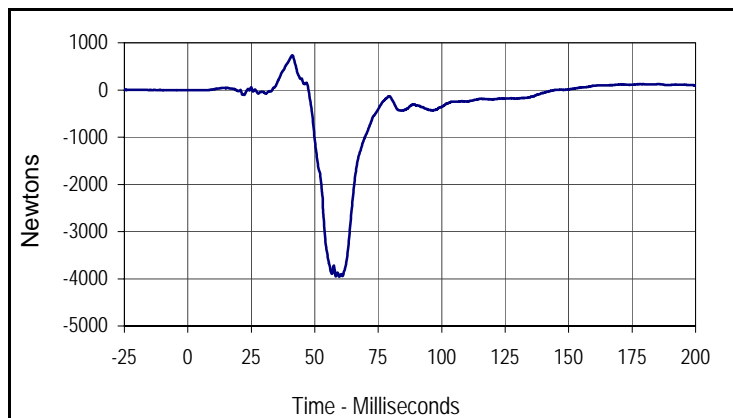

Curve Description			
Driver Left Femur Force Z			
CURNO	Type	SAE Class	Units
007	FIL	600	Newtons
Max	Time	Min	Time
737.4	41.1	-3955.3	59.7

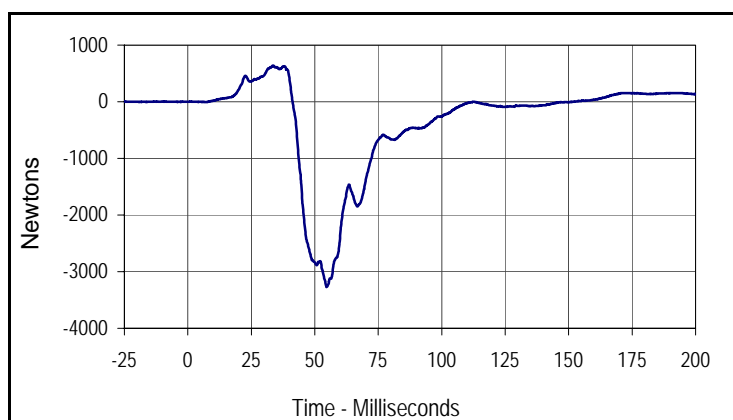

Curve Description			
Driver Right Femur Force Z			
CURNO	Type	SAE Class	Units
008	FIL	600	Newtons
Max	Time	Min	Time
640.9	33.6	-3270.5	54.7

Test Vehicle: 2009 Hyundai Sonata 4-Door Sedan
 Test Program: NHTSA 35mph NCAP

Test Date: 8/22/08
 NHTSA No.: M90502

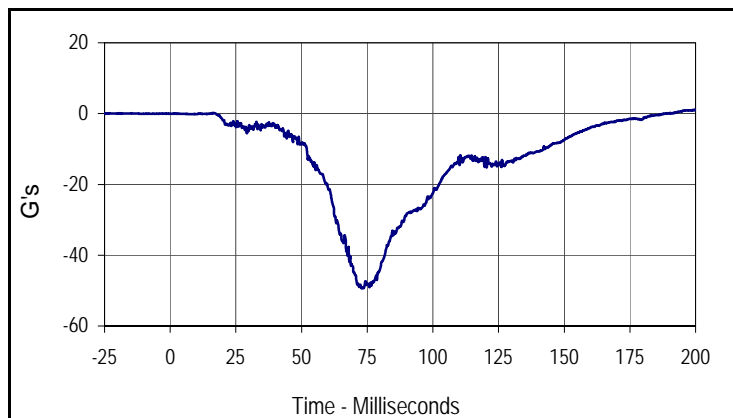

Curve Description			
Passenger Head Primary X			
CURNO	Type	SAE Class	Units
009	FIL	1000	G's
Max	Time	Min	Time
1.1	199.4	-49.4	72.9

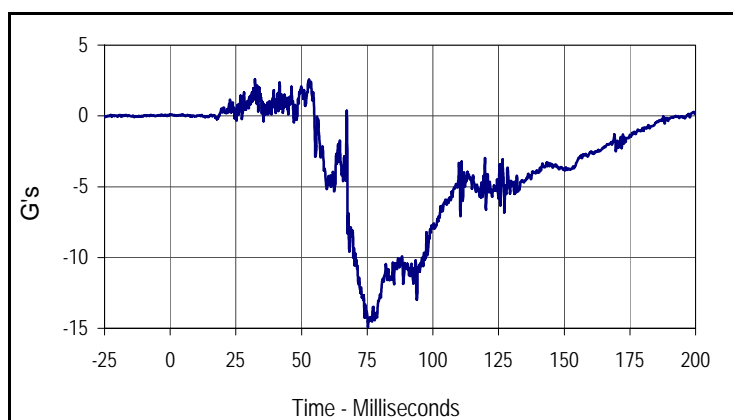

Curve Description			
Passenger Head Primary Y			
CURNO	Type	SAE Class	Units
010	FIL	1000	G's
Max	Time	Min	Time
2.6	32.3	-14.9	75.2

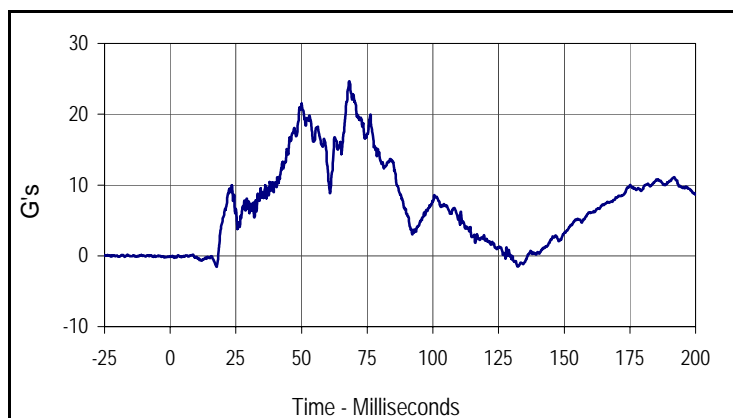

Curve Description			
Passenger Head Primary Z			
CURNO	Type	SAE Class	Units
011	FIL	1000	G's
Max	Time	Min	Time
24.7	68.2	-1.5	17.6

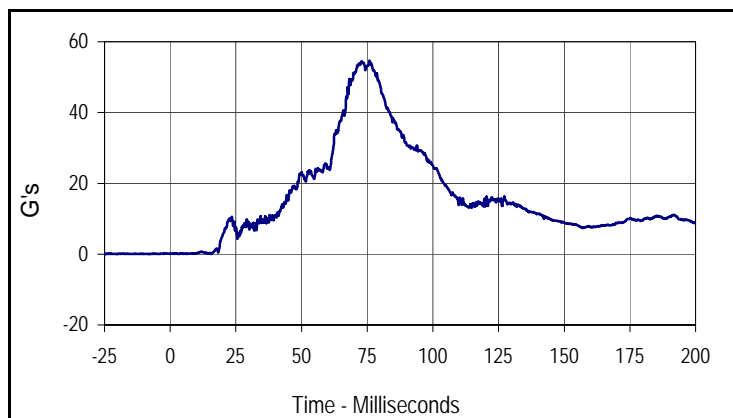

Curve Description			
Passenger Head Resultant Primary			
CURNO	Type	SAE Class	Units
009	RES	1000	G's
Max	Time	Min	Time
54.6	75.9	0.0	2.8

Test Vehicle: 2009 Hyundai Sonata 4-Door Sedan
 Test Program: NHTSA 35mph NCAP

Test Date: 8/22/08
 NHTSA No.: M90502

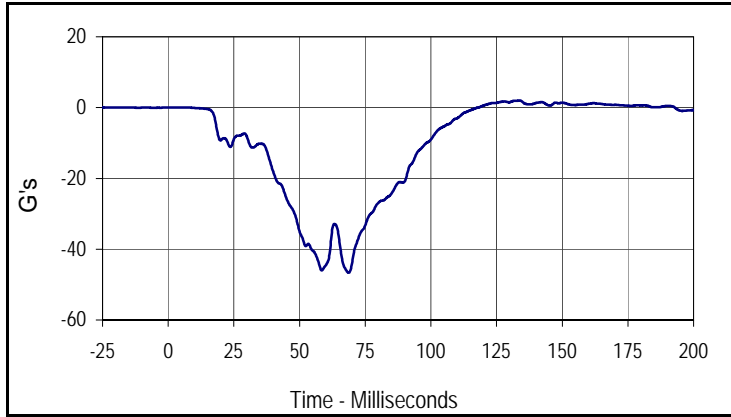

Curve Description			
Passenger Chest Primary X			
CURNO	Type	SAE Class	Units
012	FIL	180	G's
Max	Time	Min	Time
2.0	133.8	-46.7	68.7

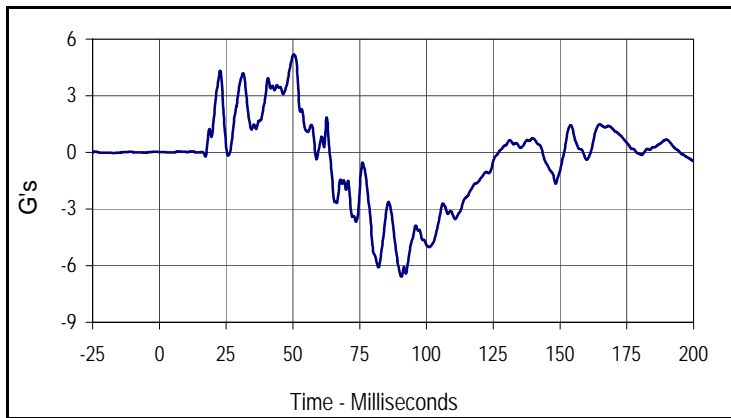

Curve Description			
Passenger Chest Primary Y			
CURNO	Type	SAE Class	Units
013	FIL	180	G's
Max	Time	Min	Time
5.2	50.3	-6.6	90.6

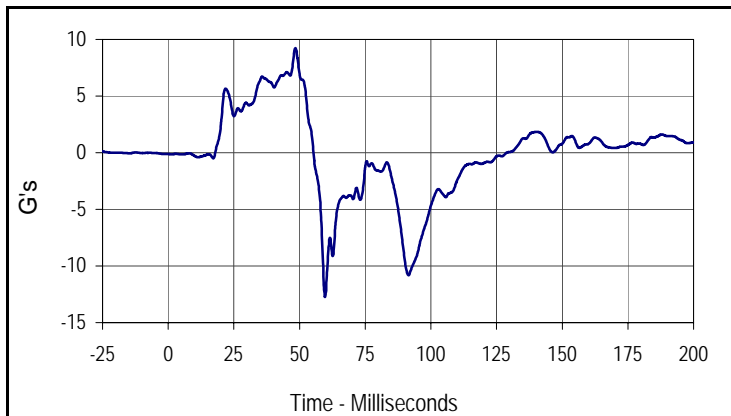

Curve Description			
Passenger Chest Primary Z			
CURNO	Type	SAE Class	Units
014	FIL	180	G's
Max	Time	Min	Time
9.2	48.4	-12.7	59.7

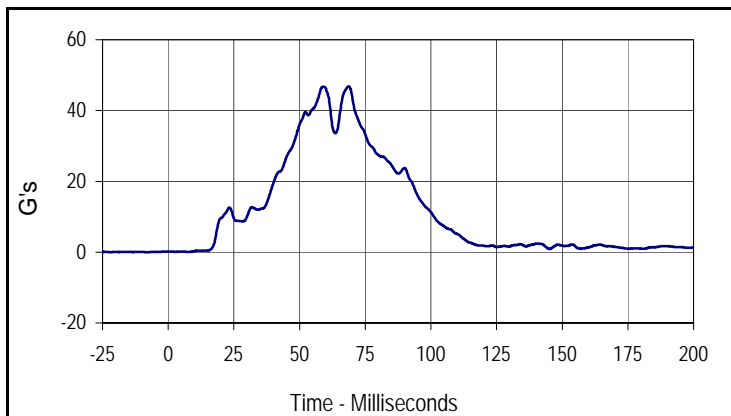

Curve Description			
Passenger Chest Resultant Primary			
CURNO	Type	SAE Class	Units
012	RES	180	G's
Max	Time	Min	Time
46.8	68.7	0.1	8.0

Test Vehicle: 2009 Hyundai Sonata 4-Door Sedan
 Test Program: NHTSA 35mph NCAP

Test Date: 8/22/08
 NHTSA No.: M90502

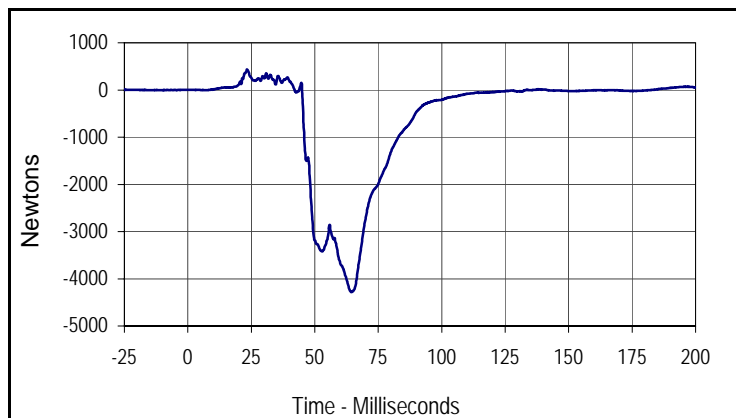

Curve Description			
Passenger Left Femur Force Z			
CURNO	Type	SAE Class	Units
015	FIL	600	Newtons
Max	Time	Min	Time
434.2	23.3	-4280.4	64.4

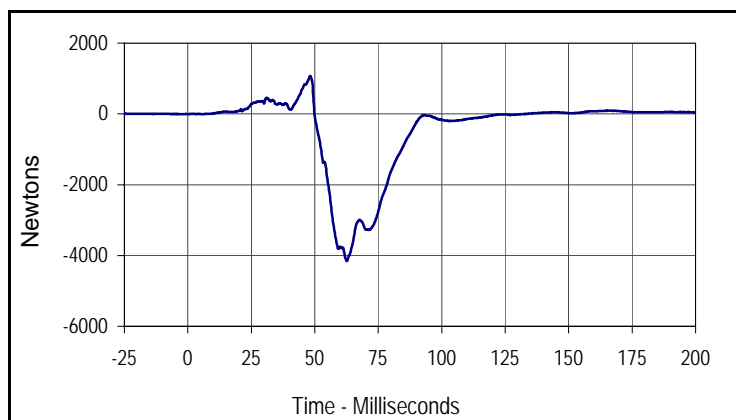

Curve Description			
Passenger Right Femur Force Z			
CURNO	Type	SAE Class	Units
016	FIL	600	Newtons
Max	Time	Min	Time
1067.1	48.2	-4156.4	62.6

APPENDIX C
DUMMY CALIBRATION DATA

Test Program: Hybrid III 50th Percentile Male Head Drop Test

Test Date: 7/23/08

ATD Serial No.: 034

Test I.D.: HD7Q



Tested Parameter	Units	Specification	Result	Pass/Fail
Laboratory Temperature	°C	18.9 to 25.6	21.1	Pass
Laboratory Relative Humidity	%	10 to 70	30	Pass
Peak Resultant Acceleration	G's	225.0 to 275.0	239.5	Pass
Peak Lateral Acceleration	G's	≤15.0	7.3	Pass
Is Acceleration Unimodal?	Yes/No	Yes	Yes	Pass
Overall Test Results			Pass	

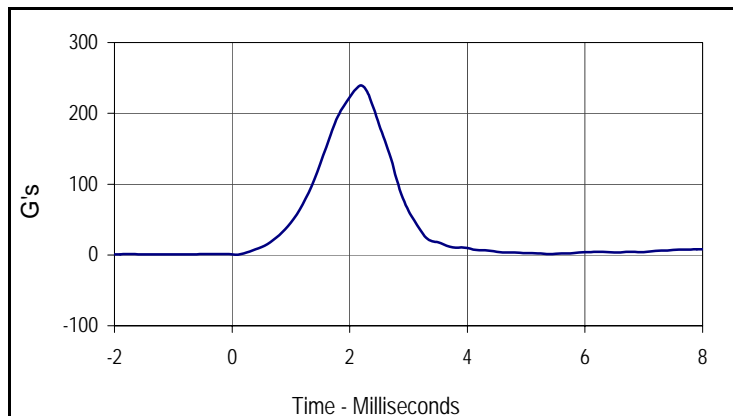

Curve Description			
Head Resultant			
CURNO	Type	SAE Class	Units
001	RES	1000	G's
Max	Time	Min	Time
239.5	2.2	0.2	0.1

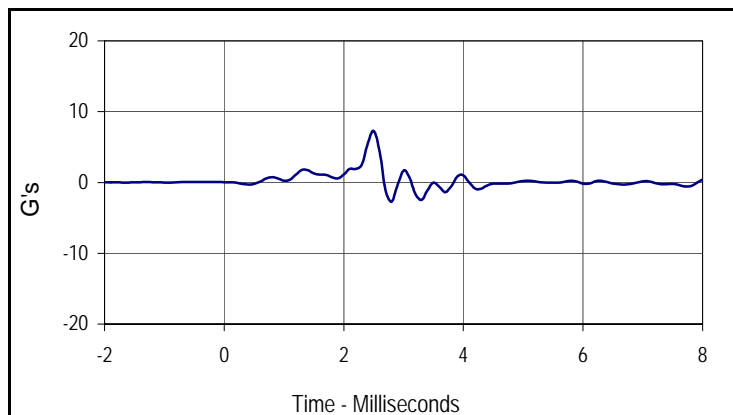

Curve Description			
Head Y			
CURNO	Type	SAE Class	Units
002	FIL	1000	G's
Max	Time	Min	Time
7.3	2.5	-2.7	2.8

Test Program: Hybrid III 50th Percentile Male Thorax Impact Test

Test Date: 7/23/08

ATD Serial No.: 034

Test I.D.: CH07Q



Tested Parameter	Units	Specification	Result	Pass/Fail
Laboratory Temperature	°C	20.6 to 22.2	21.1	Pass
Laboratory Relative Humidity	%	10 to 70	30	Pass
Probe Velocity	m/s	6.58 to 6.82	6.63	Pass
Peak Probe Force	Newtons	5159 to 5893	5266	Pass
Peak Sternum Deflection	CM	6.35 to 7.26	7.06	Pass
Internal Hysteresis	%	69 to 85	75.4	Pass
Overall Test Results				Pass

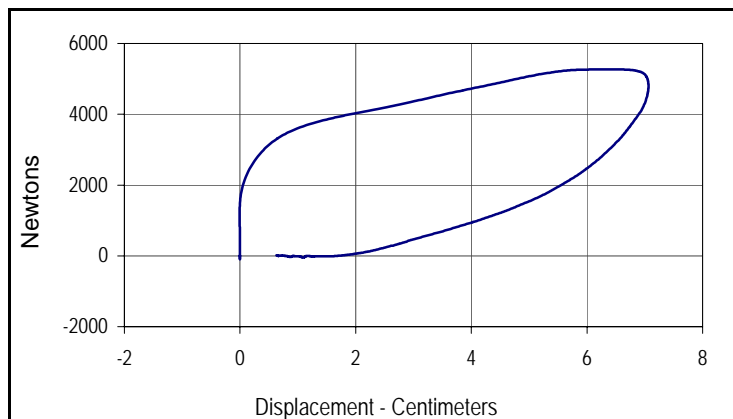

Curve Description			
Probe Force vs. Chest Deflection			
CURNO	Type	SAE Class	Hysteresis
001	FIL	180	75.4
Peak Probe Force		Peak Chest Deflection	
5266		7.06	

Test Program: Hybrid III 50th Percentile Male Neck Flexion Test

Test Date: 7/23/08

ATD Serial No.: 034

Test I.D.: NF07Q



Tested Parameter	Units	Specification	Result	Pass/Fail	
Laboratory Temperature	°C	20.6 to 22.2	21.1	Pass	
Laboratory Relative Humidity	%	10 to 70	30	Pass	
Pendulum Velocity	m/s	6.89 to 7.13	7.04	Pass	
Pendulum Deceleration	10 Msec.	G's	22.5 to 27.5	22.6	Pass
	20 Msec.	G's	17.6 to 22.6	22.2	Pass
	30 Msec.	G's	12.5 to 18.5	15.0	Pass
Peak Pendulum Decel. after 30 Msec.	G's	≤ 29.0	15.0	Pass	
Deceleration Decay, Time to Cross 5 G's	Msec.	34.0 to 42.0	39.9	Pass	
Maximum "D" Plane Rotation	Max	Degrees	64.0 to 78.0	70.5	Pass
	Time	Msec.	57.0 to 64.0	62.7	Pass
"D" Plane Rotation Decay, Time To Zero Crossing	Msec.	113.0 to 128.0	115.4	Pass	
Moment About Occ. Condyle	Max	Nm	84.1 to 108.5	90.7	Pass
	Time	Msec.	47.0 to 58.0	52.1	Pass
Positive Moment Decay, Time To Zero Crossing	Msec.	97.0 to 107.0	97.0	Pass	
Overall Test Results				Pass	

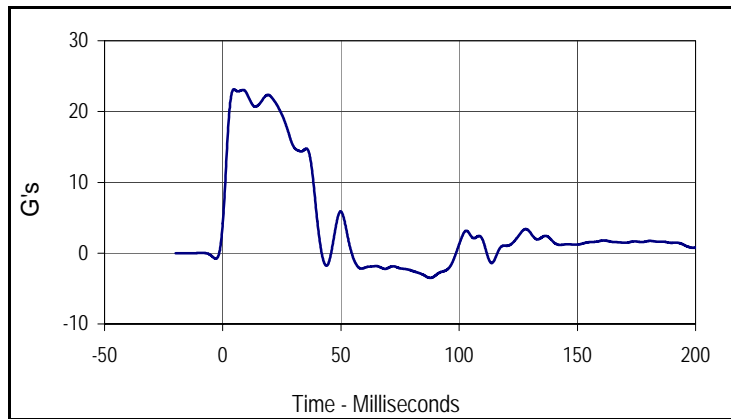

Curve Description			
Pendulum Deceleration			
CURNO	Type	SAE Class	Units
001	FIL	60	G's
Max	Time	Min	Time
23.1	4.7	-3.5	87.8

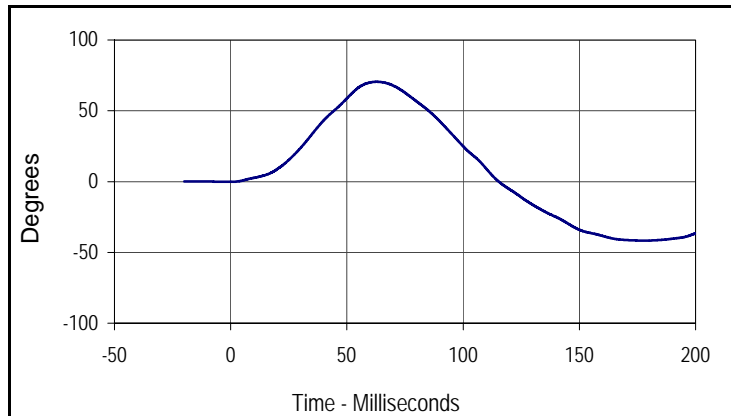

Curve Description			
"D" Plane Rotation			
CURNO	Type	SAE Class	Units
003	FIL	60	Degrees
Max	Time	Min	Time
70.5	62.7	-41.6	178.6

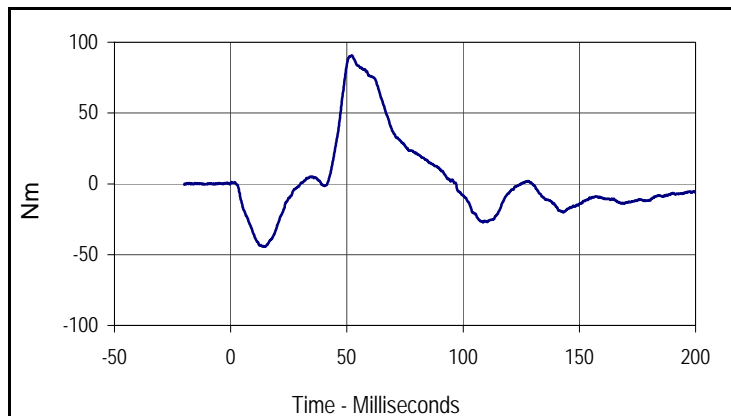

Curve Description			
Moment About Occipital Condyle			
CURNO	Type	SAE Class	Units
004	FIL	600	Nm
Max	Time	Min	Time
90.7	52.1	-44.4	14.7

Test Program: Hybrid III 50th Percentile Male Neck Extension Test

Test Date: 7/23/08

ATD Serial No.: 034

Test I.D.: NE07Q



Tested Parameter	Units	Specification	Result	Pass/Fail	
Laboratory Temperature	°C	20.6 to 22.2	21.1	Pass	
Laboratory Relative Humidity	%	10 to 70	30	Pass	
Pendulum Velocity	m/s	5.94 to 6.19	6.16	Pass	
Pendulum Deceleration	10 Msec.	G's	17.2 to 21.2	18.5	Pass
	20 Msec.	G's	14.0 to 19.0	18.5	Pass
	30 Msec.	G's	11.0 to 16.0	15.8	Pass
Peak Pendulum Decel. after 30 Msec.	G's	≤ 22.0	15.8	Pass	
Deceleration Decay, Time to Cross 5 G's	Msec.	38.0 to 46.0	43.2	Pass	
Maximum "D" Plane Rotation	Max	Degrees	81.0 to 106.0	90.6	Pass
	Time	Msec.	72.0 to 82.0	73.0	Pass
"D" Plane Rotation Decay, Time To Zero Crossing	Msec.	147.0 to 174.0	151.7	Pass	
Moment About Occ. Condyle	Max	Nm	-52.9 to- 79.9	-78.3	Pass
	Time	Msec.	65.0 to 79.0	69.7	Pass
Positive Moment Decay, Time To Zero Crossing	Msec.	120.0 to 148.0	138.9	Pass	
Overall Test Results				Pass	

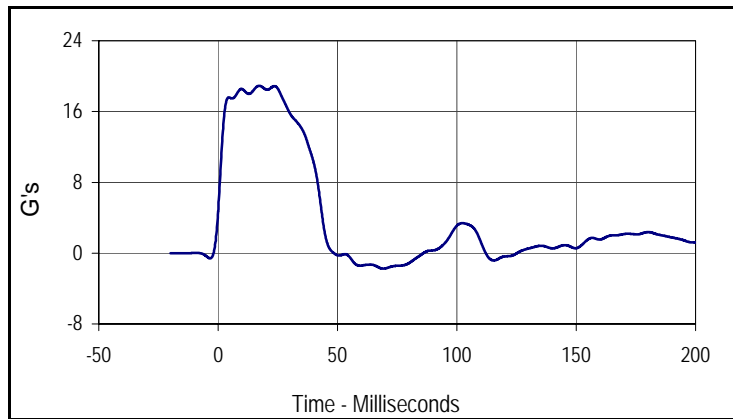

Curve Description			
Pendulum Deceleration			
CURNO	Type	SAE Class	Units
001	FIL	60	G's
Max	Time	Min	Time
18.9	17.2	-1.8	69.1

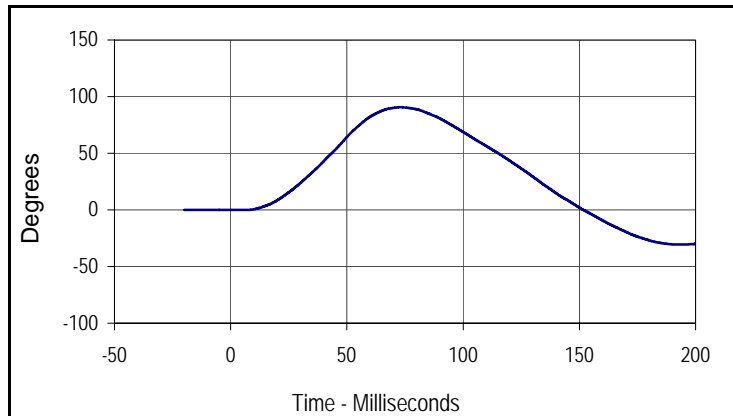

Curve Description			
"D" Plane Rotation			
CURNO	Type	SAE Class	Units
003	FIL	60	Degrees
Max	Time	Min	Time
90.6	73.0	-30.6	192.9

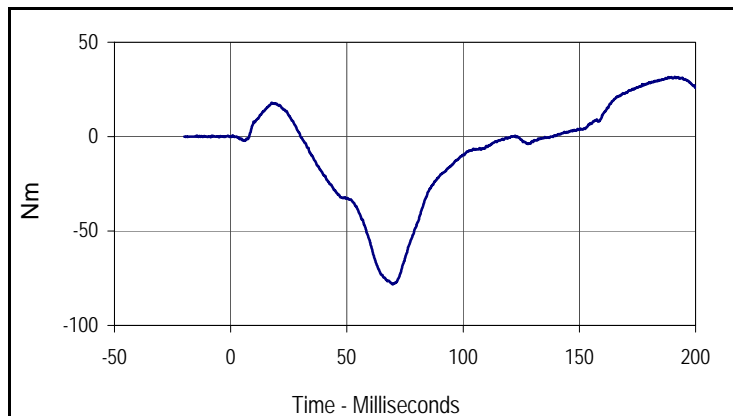

Curve Description			
Moment About Occipital Condyle			
CURNO	Type	SAE Class	Units
004	FIL	600	Nm
Max	Time	Min	Time
31.6	191.1	-78.3	69.7

Test Program: Hybrid III 50th Percentile Male Knee Impact Test

Test Date: 7/23/08

ATD Serial No.: 034

Test I.D.: LK07Q , RK07Q



Left Knee

Tested Parameter	Units	Specification	Result	Pass/Fail
Laboratory Temperature	°C	18.9 to 25.6	21.1	Pass
Laboratory Relative Humidity	%	10 to 70	30	Pass
Pendulum Velocity at T=0	m/sec	2.07 to 2.13	2.10	Pass
Peak Probe Force	Newtons	4715 to 5782	5668	Pass
Overall Test Results				Pass

Right Knee

Pendulum Velocity at T=0	m/sec	2.07 to 2.13	2.12	Pass
Peak Probe Force	Newtons	4715 to 5782	5625	Pass
Overall Test Results				Pass

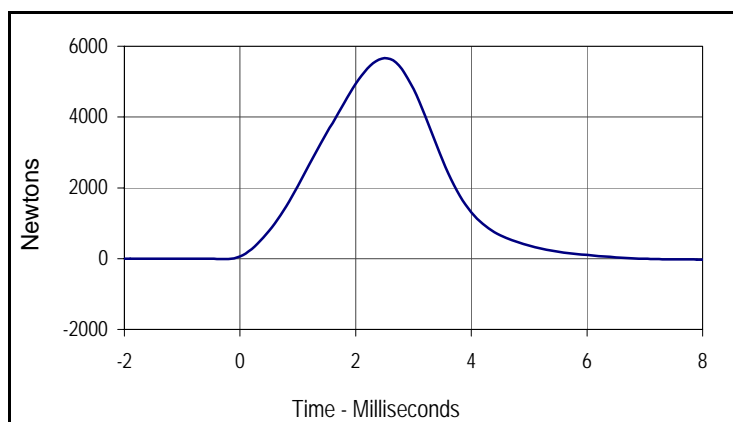

Curve Description			
Left Knee Probe Force			
CURNO	Type	SAE Class	Units
001	FIL	600	Newtons
Max	Time	Min	Time
5668.1	2.5	-25.4	8.0

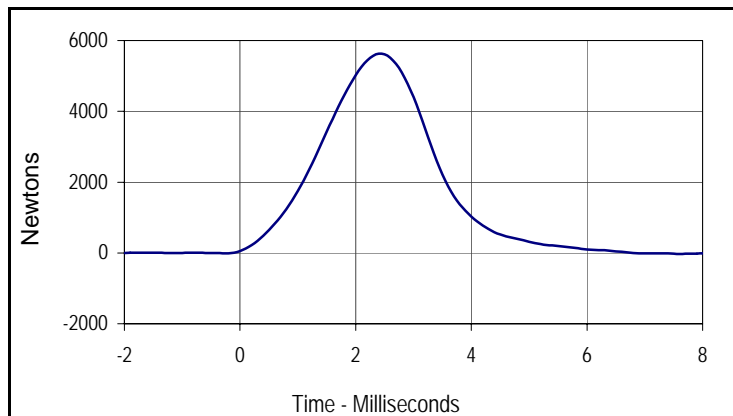

Curve Description			
Right Knee Probe Force			
CURNO	Type	SAE Class	Units
002	FIL	600	Newtons
Max	Time	Min	Time
5625.1	2.4	-25.4	7.6

Test Program: Hybrid III 50th Percentile Male External Measurements

Test Date: 7/23/08

ATD Serial No.: 034

Test I.D.: N/A



Tested Parameter	Units	Specification	Result	Pass/Fail
Laboratory Temperature	°C	20.6 to 22.2	21.1	Pass
Laboratory Relative Humidity	%	10 to 70	30	Pass
A - Total sitting height	mm	879 to 889	885	Pass
B - Shoulder pivot height	mm	505 to 521	518	Pass
C - "H" point height	mm	84 to 89	87	Pass
D - "H" point from seat back	mm	135 to 140	139	Pass
E - Shoulder pivot from back	mm	84 to 94	90	Pass
F - Thigh clearance	mm	140 to 155	145	Pass
G - Elbow back to wrist pivot	mm	290 to 305	299	Pass
H - Skull cap to back line	mm	41 to 46	45	Pass
I - Shoulder to elbow length	mm	330 to 345	341	Pass
J - Elbow rest height	mm	190 to 211	195	Pass
K - Buttock to knee length	mm	579 to 604	598	Pass
L - Popliteal length	mm	429 to 455	450	Pass
M - Knee pivot height	mm	485 to 500	491	Pass
N - Buttock popliteal length	mm	452 to 477	473	Pass
O - Chest depth	mm	213 to 229	215	Pass
P - Foot length	mm	251 to 267	257	Pass
V - Shoulder breadth	mm	422 to 437	430	Pass
W - Foot breadth	mm	91 to 107	102	Pass
Y - Chest circumference	mm	970 to 1001	998	Pass
Z - Waist circumference	mm	836 to 866	862	Pass
AA - Location for chest circumference	mm	429 to 434	430	Pass
BB - Location for waist circumference	mm	226 to 231	228	Pass
Overall Test Results				Pass

Test Program: Hybrid III 50th Percentile Male Head Drop Test

Test Date: 7/23/08

ATD Serial No.: 035

Test I.D.: HD07P



Tested Parameter	Units	Specification	Result	Pass/Fail
Laboratory Temperature	°C	18.9 to 25.6	21.1	Pass
Laboratory Relative Humidity	%	10 to 70	30	Pass
Peak Resultant Acceleration	G's	225.0 to 275.0	253.1	Pass
Peak Lateral Acceleration	G's	≤15.0	11.8	Pass
Is Acceleration Unimodal?	Yes/No	Yes	Yes	Pass
Overall Test Results			Pass	

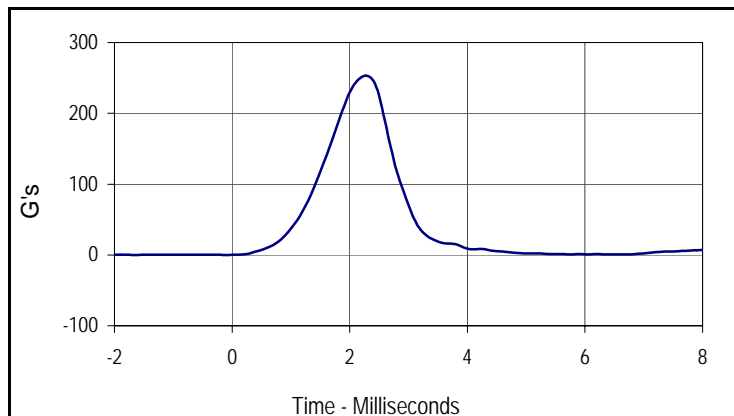

Curve Description			
Head Resultant			
CURNO	Type	SAE Class	Units
001	RES	1000	G's
Max	Time	Min	Time
253.1	2.3	0.1	-0.1

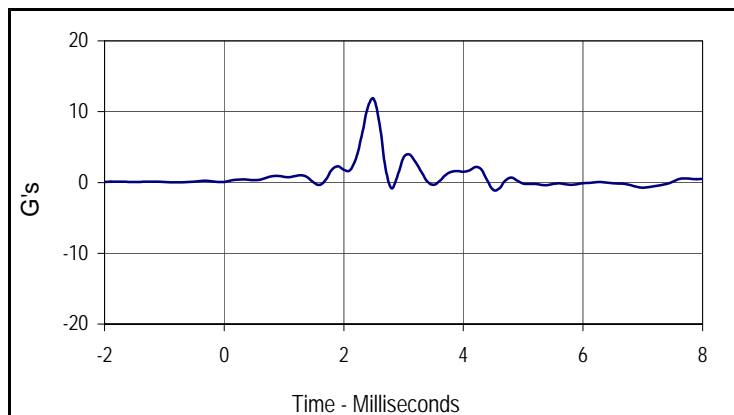

Curve Description			
Head Y			
CURNO	Type	SAE Class	Units
002	FIL	1000	G's
Max	Time	Min	Time
11.8	2.5	-1.1	4.5

Test Program: Hybrid III 50th Percentile Male Thorax Impact Test

Test Date: 7/23/08

ATD Serial No.: 035

Test I.D.: CH07P



Tested Parameter	Units	Specification	Result	Pass/Fail
Laboratory Temperature	°C	20.6 to 22.2	21.1	Pass
Laboratory Relative Humidity	%	10 to 70	30	Pass
Probe Velocity	m/s	6.58 to 6.82	6.67	Pass
Peak Probe Force	Newtons	5159 to 5893	5495	Pass
Peak Sternum Deflection	CM	6.35 to 7.26	7.15	Pass
Internal Hysteresis	%	69 to 85	72.7	Pass
Overall Test Results				Pass

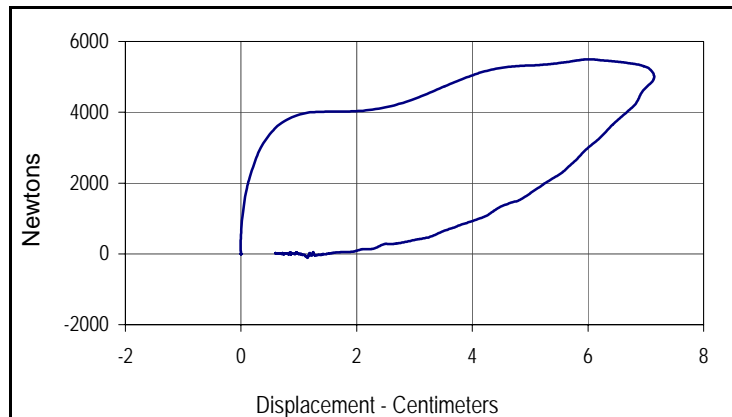

Curve Description			
Probe Force vs. Chest Deflection			
CURNO	Type	SAE Class	Hysteresis
001	FIL	180	72.7
Peak Probe Force		Peak Chest Deflection	
5495		7.15	

Test Program: Hybrid III 50th Percentile Male Neck Flexion Test

Test Date: 7/23/08

ATD Serial No.: 035

Test I.D.: NF07P



Tested Parameter	Units	Specification	Result	Pass/Fail	
Laboratory Temperature	°C	20.6 to 22.2	21.1	Pass	
Laboratory Relative Humidity	%	10 to 70	30	Pass	
Pendulum Velocity	m/s	6.89 to 7.13	7.04	Pass	
Pendulum Deceleration	10 Msec.	G's	22.5 to 27.5	22.7	Pass
	20 Msec.	G's	17.6 to 22.6	19.9	Pass
	30 Msec.	G's	12.5 to 18.5	16.5	Pass
Peak Pendulum Decel. after 30 Msec.	G's	≤ 29.0	16.5	Pass	
Deceleration Decay, Time to Cross 5 G's	Msec.	34.0 to 42.0	36.5	Pass	
Maximum "D" Plane Rotation	Max	Degrees	64.0 to 78.0	68.2	Pass
	Time	Msec.	57.0 to 64.0	62.6	Pass
"D" Plane Rotation Decay, Time To Zero Crossing	Msec.	113.0 to 128.0	122.1	Pass	
Moment About Occ. Condyle	Max	Nm	84.1 to 108.5	87.1	Pass
	Time	Msec.	47.0 to 58.0	49.8	Pass
Positive Moment Decay, Time To Zero Crossing	Msec.	97.0 to 107.0	100.3	Pass	
Overall Test Results				Pass	

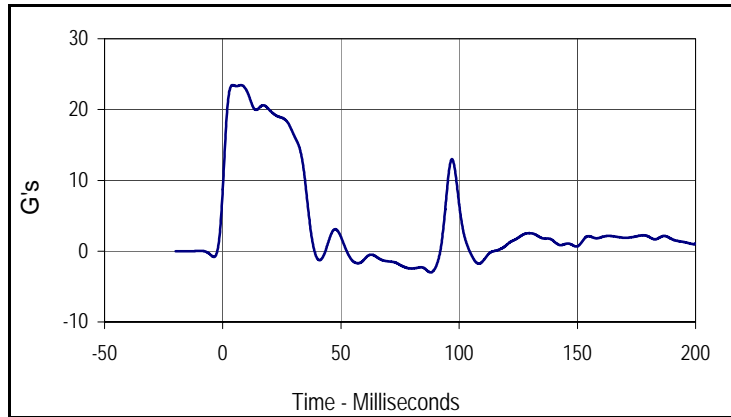

Curve Description			
Pendulum Deceleration			
CURNO	Type	SAE Class	Units
001	FIL	60	G's
Max	Time	Min	Time
23.5	7.7	-3.0	87.9

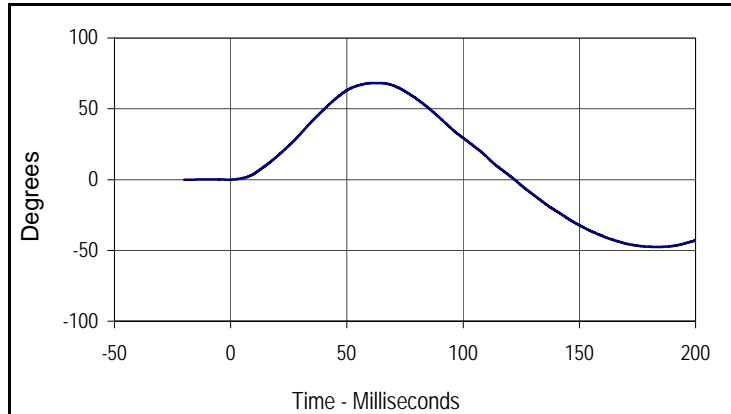

Curve Description			
"D" Plane Rotation			
CURNO	Type	SAE Class	Units
003	FIL	60	Degrees
Max	Time	Min	Time
68.2	62.6	-47.5	183.5

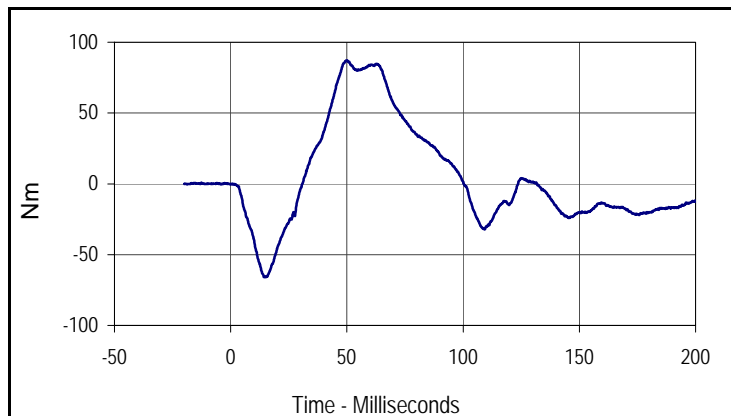

Curve Description			
Moment About Occipital Condyle			
CURNO	Type	SAE Class	Units
004	FIL	600	Nm
Max	Time	Min	Time
87.1	49.8	-65.9	15.0

Test Program: Hybrid III 50th Percentile Male Neck Extension Test

Test Date: 7/23/08

ATD Serial No.: 035

Test I.D.: NE07P



Tested Parameter	Units	Specification	Result	Pass/Fail	
Laboratory Temperature	°C	20.6 to 22.2	21.1	Pass	
Laboratory Relative Humidity	%	10 to 70	30	Pass	
Pendulum Velocity	m/s	5.94 to 6.19	6.16	Pass	
Pendulum Deceleration	10 Msec.	G's	17.2 to 21.2	17.9	Pass
	20 Msec.	G's	14.0 to 19.0	17.2	Pass
	30 Msec.	G's	11.0 to 16.0	14.8	Pass
Peak Pendulum Decel. after 30 Msec.	G's	≤ 22.0	14.8	Pass	
Deceleration Decay, Time to Cross 5 G's	Msec.	38.0 to 46.0	39.6	Pass	
Maximum "D" Plane Rotation	Max	Degrees	81.0 to 106.0	92.7	Pass
	Time	Msec.	72.0 to 82.0	73.7	Pass
"D" Plane Rotation Decay, Time To Zero Crossing	Msec.	147.0 to 174.0	154.3	Pass	
Moment About Occ. Condyle	Max	Nm	-52.9 to- 79.9	-63.8	Pass
	Time	Msec.	65.0 to 79.0	66.4	Pass
Positive Moment Decay, Time To Zero Crossing	Msec.	120.0 to 148.0	135.0	Pass	
Overall Test Results				Pass	

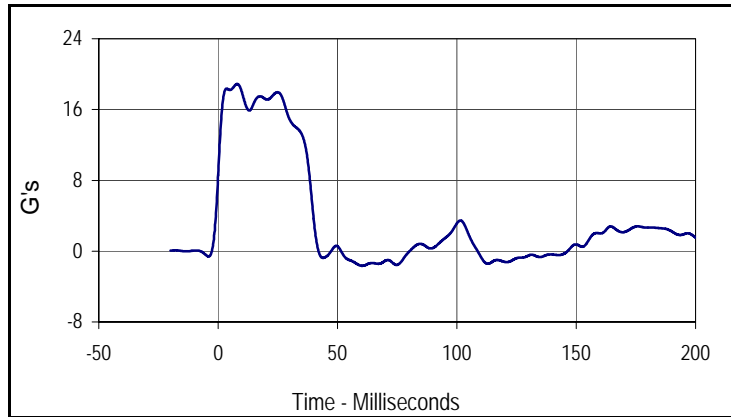

Curve Description			
Pendulum Deceleration			
CURNO	Type	SAE Class	Units
001	FIL	60	G's
Max	Time	Min	Time
18.9	8.0	-1.7	60.3

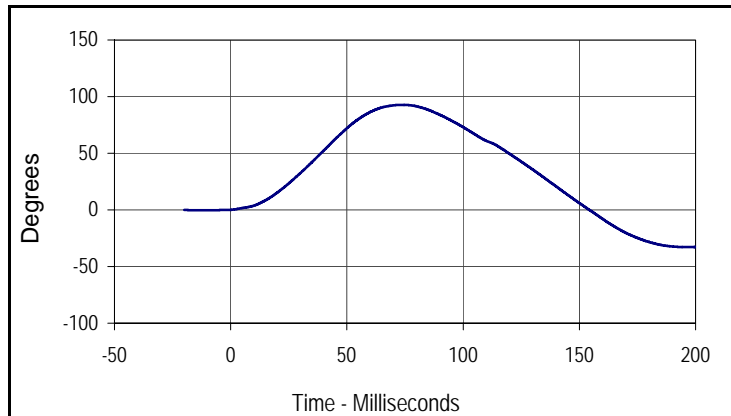

Curve Description			
"D" Plane Rotation			
CURNO	Type	SAE Class	Units
003	FIL	60	Degrees
Max	Time	Min	Time
92.7	73.7	-32.8	196.1

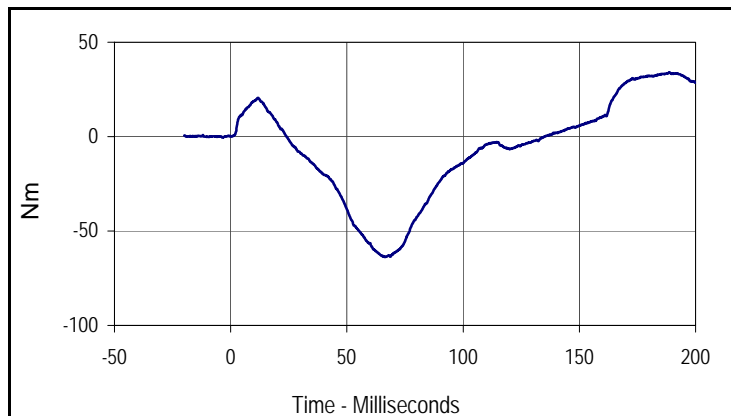

Curve Description			
Moment About Occipital Condyle			
CURNO	Type	SAE Class	Units
004	FIL	600	Nm
Max	Time	Min	Time
34.0	188.9	-63.8	66.4

Test Program: Hybrid III 50th Percentile Male Knee Impact Test

Test Date: 7/23/08

ATD Serial No.: 035

Test I.D.: LK07P , RK07P



Left Knee

Tested Parameter	Units	Specification	Result	Pass/Fail
Laboratory Temperature	°C	18.9 to 25.6	21.1	Pass
Laboratory Relative Humidity	%	10 to 70	30	Pass
Pendulum Velocity at T=0	m/sec	2.07 to 2.13	2.10	Pass
Peak Probe Force	Newtons	4715 to 5782	5356	Pass
Overall Test Results				Pass

Right Knee

Pendulum Velocity at T=0	m/sec	2.07 to 2.13	2.12	Pass
Peak Probe Force	Newtons	4715 to 5782	5536	Pass
Overall Test Results				Pass

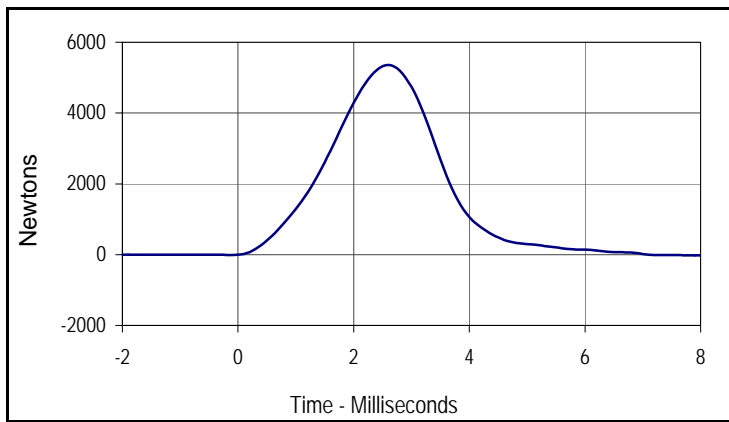

Curve Description			
Left Knee Probe Force			
CURNO	Type	SAE Class	Units
001	FIL	600	Newtons
Max	Time	Min	Time
5356.0	2.6	-28.0	9.6

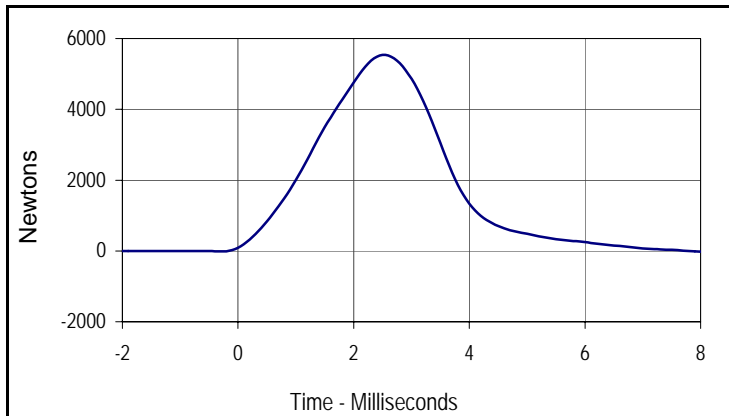

Curve Description			
Right Knee Probe Force			
CURNO	Type	SAE Class	Units
002	FIL	600	Newtons
Max	Time	Min	Time
5536.4	2.5	-32.5	8.7

Test Program: Hybrid III 50th Percentile Male External Measurements

Test Date: 7/23/08

ATD Serial No.: 035

Test I.D.: N/A



Tested Parameter	Units	Specification	Result	Pass/Fail
Laboratory Temperature	°C	20.6 to 22.2	21.1	Pass
Laboratory Relative Humidity	%	10 to 70	30	Pass
A - Total sitting height	mm	879 to 889	883	Pass
B - Shoulder pivot height	mm	505 to 521	514	Pass
C - "H" point height	mm	84 to 89	87	Pass
D - "H" point from seat back	mm	135 to 140	136	Pass
E - Shoulder pivot from back	mm	84 to 94	85	Pass
F - Thigh clearance	mm	140 to 155	147	Pass
G - Elbow back to wrist pivot	mm	290 to 305	295	Pass
H - Skull cap to back line	mm	41 to 46	43	Pass
I - Shoulder to elbow length	mm	330 to 345	341	Pass
J - Elbow rest height	mm	190 to 211	197	Pass
K - Buttock to knee length	mm	579 to 604	596	Pass
L - Popliteal length	mm	429 to 455	453	Pass
M - Knee pivot height	mm	485 to 500	489	Pass
N - Buttock popliteal length	mm	452 to 477	470	Pass
O - Chest depth	mm	213 to 229	224	Pass
P - Foot length	mm	251 to 267	257	Pass
V - Shoulder breadth	mm	422 to 437	426	Pass
W - Foot breadth	mm	91 to 107	102	Pass
Y - Chest circumference	mm	970 to 1001	998	Pass
Z - Waist circumference	mm	836 to 866	860	Pass
AA - Location for chest circumference	mm	429 to 434	430	Pass
BB - Location for waist circumference	mm	226 to 231	228	Pass
Overall Test Results				Pass

Test Program: Dummy Damage Checklist
 ATD Serial No.: 034

Test Date: 7/23/08
 Test I.D.: N/A



GENERAL	DAMAGED	OK
Outer skin on entire dummy		X
Head ballast secure		X
Gashes, rips, general appearance, etc.		X
Neck-Broken or cracks in rubber		X
Check that upper neck bracket is firmly attached to lwr neck bracket		X
Three rubber bumpers in place		X
Spine- Broken or cracks in rubber		X
Check for looseness at the condyle joint		X
Nodding blocks- cracked or out of position		X
Ribs- Check all ribs and rib supports for damage (bent or broken)		X
Check damping material or separation or cracks		X
OTHER		
CHEST DISPLACEMENT ASSEMBLY		
Bent shaft		X
Slider arm riding correctly, in track		X
TRANSDUCER LEADS		
Torn cables		X
ACCELEROMETER MOUNTINGS		
Check for secure mounting		X
KNEES		
Check outer skin, insert and casting (without removing insert)		X
Knee sliders - Wires intact		X
Knee sliders- Rubber returned to "at rest position"		X
LIMBS		
Check for normal movement and adjustment		X
PELVIS		
Inspect for breakage, especially at iliac crest		X

Comments on repair or replacement parts:

Test Program: Dummy Damage Checklist
 ATD Serial No.: 035

Test Date: 7/23/08
 Test I.D.: N/A



GENERAL	DAMAGED	OK
Outer skin on entire dummy		X
Head ballast secure		X
Gashes, rips, general appearance, etc.		X
Neck-Broken or cracks in rubber		X
Check that upper neck bracket is firmly attached to lwr neck bracket		X
Three rubber bumpers in place		X
Spine- Broken or cracks in rubber		X
Check for looseness at the condyle joint		X
Nodding blocks- cracked or out of position		X
Ribs- Check all ribs and rib supports for damage (bent or broken)		X
Check damping material or separation or cracks		X
OTHER		
CHEST DISPLACEMENT ASSEMBLY		
Bent shaft		X
Slider arm riding correctly, in track		X
TRANSDUCER LEADS		
Torn cables		X
ACCELEROMETER MOUNTINGS		
Check for secure mounting		X
KNEES		
Check outer skin, insert and casting (without removing insert)		X
Knee sliders - Wires intact		X
Knee sliders- Rubber returned to "at rest position"		X
LIMBS		
Check for normal movement and adjustment		X
PELVIS		
Inspect for breakage, especially at iliac crest		X

Comments on repair or replacement parts:
